



**TRIANGLE  
RESEARCH  
INTERNATIONAL**

# **Nano-10**

**Ladder+BASIC  
Super PLC**

Revision 7.2

**USER'S  
MANUAL**

## Copyright Notice and Disclaimer

All rights reserved. With the exception of legitimate TRi PLC users, who may print or make copies of this manual for reference purposes, no parts of this manual may be reproduced in any form without the express written permission of TRi.

Triangle Research International, Inc. (TRi) makes no representations or warranties with respect to the contents hereof. In addition, information contained herein is subject to change without notice. Every precaution has been taken in the preparation of this manual. Nevertheless, TRi assumes no responsibility for errors or omissions or any damages resulting from the use of the information contained in this publication.

MS-DOS and Windows are trademarks of Microsoft Inc.  
 MODBUS is a trademark of Modbus.org  
 All other trademarks belong to their respective owners.

## Revision Sheet

Release No.	Date	Revision Description
Rev. 1	4/13/2010	Added description of RC Servo Control in Chapter 11. Corrected wrong or inconsistent numbering of figures.
Rev. 2	6/22/2010	Corrected header error on Chapter 16.
Rev. 3	11/10/2010	Change all <REMOTE> tag to <REMOTEFS>.
Rev. 4	6/22/2012	Added Chapter 18 and 19. Reformatted headers and footers.
Rev. 4.1	7/19/2012	Revised digital output driver specs
Rev. 5	5/01/2013	Revised Chapter 2 layout. Modified Section 1.7 and Chapter 17
Rev. 6	9/03/2013	Added installation position warning in regards to updated relay specs.
Rev. 7	12/01/2015	Revised Sections 2.9 and 2.10 on Webpage Control
Rev. 7.1	3/01/2016	Updated specs regarding the number of simultaneous Fserver/Modbus TCP connections. Also removed outdated relay orientation references (relay orientation is not applicable to any Nano-10 PLC sold in 2016).
Rev. 7.2	03/07/2016	Updated section 18.5.2 due to program code correction

## Conditions of Sale and Product Warranty

Triangle Research International Inc. (TRi) and the Buyer agree to the following terms and conditions of Sale and Purchase:

1. The TRi Products are guaranteed against defects in materials or workmanship for a period of one year from the date of registered purchase. Any unit found during this time to have manufacturing defect/s will, at the discretion of TRi, be repaired or replaced.
2. TRi will not be responsible for the repair or replacement of any unit damaged by user modification, negligence, abuse, improper installation, or mishandling.
3. TRi is not responsible to the Buyer for any special, consequential, indirect or similar damages, including any lost profits or loss data arising from the use or the loss of use of TRi products. In no case shall TRi's liability exceed the purchase price for the products.
4. TRi products are NOT certified to be FAILSAFE and hence must NOT be used in applications where failure of the product could lead to physical harm or loss of human life. Buyer is responsible to conduct their own tests to meet the safety regulation of their respective industry.
5. Products distributed, but not manufactured by TRi, carry the full original manufacturers warranty. Such products include, but are not limited to: power supplies, sensors, I/O modules and battery backed RAM.
6. TRi reserves the right to alter any feature or specification at any time with each product revision release.

**Notes to Buyer:** If you disagree with any of the above terms or conditions you should promptly return the unit to the manufacturer or distributor within 30 days from date of purchase for a full refund.

# TABLE OF CONTENTS

	<u>Page #</u>
<b>1</b>	<b>1-1</b>
<b>1.1</b>	<b>1-1</b>
<b>1.2</b>	<b>1-2</b>
1.2.1	1-2
1.2.2	1-3
<b>1.3</b>	<b>1-3</b>
<b>1.4</b>	<b>1-4</b>
<b>1.5</b>	<b>1-5</b>
1.5.1	1-5
1.5.2	1-6
1.5.3	1-6
<b>1.6</b>	<b>1-7</b>
1.6.1	1-7
1.6.2	1-8
1.6.3	1-10
<b>1.7</b>	<b>1-10</b>
1.7.1	1-10
<b>1.8</b>	<b>1-11</b>
<b>1.9</b>	<b>1-11</b>
<b>2</b>	<b>2-1</b>
<b>2.1</b>	<b>2-1</b>
2.1.1	2-3
2.1.2	2-3
2.1.3	2-3
2.1.4	2-4
2.1.5	2-5
2.1.6	2-5
2.1.7	2-5
2.1.8	2-6
2.1.9	2-6
2.1.10	2-6
2.1.11	2-6
2.1.12	2-6
2.1.13	2-6
2.1.14	2-6
<b>2.2</b>	<b>2-8</b>
2.2.1	2-8
2.2.2	2-10
<b>2.3</b>	<b>2-16</b>
<b>2.4</b>	<b>2-17</b>
2.4.1	2-18
2.4.2	2-18

2.4.3	Send Email .....	2-19
2.4.4	Open Connection to Remote FServer or TLServer to Use NETCMD\$ .....	2-20
2.4.5	Remote File Services .....	2-20
2.4.6	Other Network Services Tags .....	2-21
<b>2.5</b>	<b>MODBUS/TCP Server and Client Connection .....</b>	<b>2-22</b>
2.5.1	Connecting To The PLC's MODBUS/TCP Server.....	2-22
2.5.1.1	Bit Address Mapping.....	2-22
2.5.1.2	Word Address Mapping .....	2-24
2.5.2	MODBUS/TCP Access Security.....	2-24
2.5.3	Making A Modbus/TCP Client Connection to Other Modbus/TCP Server .....	2-25
<b>2.6</b>	<b>Getting data from Internet: Connecting to The Internet Time Server.....</b>	<b>2-27</b>
<b>2.7</b>	<b>Web Service: Accessing PLC's data from MS Excel .....</b>	<b>2-28</b>
<b>2.8</b>	<b>Accessing The PLC from Internet .....</b>	<b>2-30</b>
2.8.1	Small Local Area Network Using Consumer Grade Network Router .....	2-30
2.8.2	Large Corporate Local Area Network.....	2-31
<b>2.9</b>	<b>Installing a Web Page or Web Applet into the Nano-10 PLC using FileZilla .....</b>	<b>2-32</b>
2.9.1	Installing the FileZilla program.....	2-32
2.9.2	Configuring FileZilla to Communicate with the Nano-10 .....	2-32
2.9.3	Transferring and Retrieving Files from the Nano-10 Web Server .....	2-35
2.9.4	Download the Web Page Files .....	2-36
2.9.5	Troubleshooting FileZilla File Transfer Problems.....	2-36
<b>2.10</b>	<b>Accessing and Customizing the HTML Web Interface for Control and Monitoring .....</b>	<b>2-39</b>
2.10.1	Next Generation of Super PLC Web Control .....	2-39
2.10.2	Advanced Customization.....	2-40
<b>3</b>	<b>DIGITAL I/O AND INTERNAL RELAYS PROGRAMMING .....</b>	<b>3-1</b>
<b>3.1</b>	<b>Introduction .....</b>	<b>3-1</b>
<b>3.2</b>	<b>Programming DIO with Ladder Logic .....</b>	<b>3-1</b>
3.2.1	For Physical I/O .....	3-1
3.2.2	For Internal Relays (Non-Latching) .....	3-1
3.2.3	For Internal Relays (Latching) .....	3-1
3.2.4	Programming Examples: .....	3-2
3.2.4.1	Example 1 – Editing Label Names.....	3-2
3.2.4.2	Example 2 – Creating a Simple Ladder Logic Circuit .....	3-2
3.2.4.3	Example 3 – Creating a Latching Relay Circuit .....	3-2
<b>3.3</b>	<b>Programming DIO in a Custom Function .....</b>	<b>3-3</b>
3.3.1	Editing Label Names: .....	3-3
3.3.2	Controlling I/O from Custom Functions: .....	3-3
3.3.3	Example 1 – Turn on/off an Output .....	3-4
3.3.4	Example 2 – Toggle an Output.....	3-5
3.3.5	Example 3 – Test the Status of an Output .....	3-5
<b>4</b>	<b>TIMERS, COUNTERS AND SEQUENCERS .....</b>	<b>4-1</b>
<b>4.1</b>	<b>Introduction .....</b>	<b>4-1</b>
4.1.1	Timer Coils .....	4-1
4.1.2	Counter Coils.....	4-1
4.1.3	Sequencers .....	4-1
<b>4.2</b>	<b>Programming timers and counters on Ladder Logic .....</b>	<b>4-2</b>
4.2.1	For Timers .....	4-2
4.2.2	For Counters.....	4-2

4.2.3	Example 1 – Creating a Simple Timer Circuit in Ladder Logic.....	4-2
4.2.4	Example 2 – Creating a Simple Counter Circuit in Ladder Logic .....	4-3
<b>4.3</b>	<b>Programming timers and counters in Custom Function .....</b>	<b>4-4</b>
4.3.1	Programming Timers and Counters Present Values.....	4-4
4.3.2	Accessing Inputs, Outputs, Relays, Timers and Counters Contacts.....	4-4
4.3.3	Changing The Timer and Counter Set Values in a Custom Function .....	4-4
4.3.4	Volatility of Nano-10 Timer & Counter Set Values.....	4-4
4.3.5	Controlling a Timer or Counter in a Custom Function .....	4-5
<b>4.4</b>	<b>Programming Sequencers on Ladder Logic .....</b>	<b>4-5</b>
4.4.1	Introduction.....	4-5
4.4.2	Advance Sequencer - [AVseq] .....	4-6
4.4.3	Resetting Sequencer - [RSseq].....	4-6
4.4.4	Setting Sequencer to Step N - [StepN].....	4-6
4.4.5	Reversing a Sequencer .....	4-6
4.4.6	Program Example.....	4-7
<b>4.5</b>	<b>Programming Sequencers in Custom Function .....</b>	<b>4-7</b>
<b>5</b>	<b>ANALOG INPUTS .....</b>	<b>5-1</b>
<b>5.1</b>	<b>Analog Power Supply .....</b>	<b>5-1</b>
<b>5.2</b>	<b>Analog Inputs .....</b>	<b>5-1</b>
5.2.1	Interfacing to two-wire 4-20mA sensors .....	5-2
5.2.2	Using Potentiometer to Set Parameters.....	5-3
5.2.3	Reading Analog Input Data.....	5-3
5.2.4	Moving Average.....	5-4
5.2.5	Scaling of Analog Data .....	5-4
<b>5.3</b>	<b>Temperature Measurement Using Analog Inputs.....</b>	<b>5-5</b>
5.3.1	Thermistor Temperature Sensors .....	5-5
5.3.2	Using LM34 Semiconductor Sensor .....	5-6
5.3.3	Using Thermocouple .....	5-7
5.3.4	Using PT100 Temperature Sensor.....	5-7
<b>5.4</b>	<b>Calibration of ADC &amp; Moving Average Definition.....</b>	<b>5-7</b>
5.4.1	ADC Calib. ....	5-7
5.4.2	ADC Zero Offset.....	5-8
5.4.3	A/D Moving Avg.....	5-9
<b>6</b>	<b>SPECIAL DIGITAL I/OS .....</b>	<b>6-1</b>
<b>7</b>	<b>HIGH SPEED COUNTERS .....</b>	<b>7-1</b>
7.1	Introduction.....	7-1
7.2	Enhanced Quadrature Decoding.....	7-2
7.3	Configuring HSC as x1, x2 or x4 Counters .....	7-2
7.4	Interfacing to 5V type Quadrature Encoder .....	7-3
<b>8</b>	<b>FREQUENCY / SPEED MEASUREMENT .....</b>	<b>8-1</b>
<b>8.1</b>	<b>Programming of PM Input.....</b>	<b>8-1</b>
<b>8.2</b>	<b>Applications .....</b>	<b>8-2</b>
8.2.1	Measuring RPM Of A Motor .....	8-2
8.2.2	Measuring Transducer with VCO Outputs.....	8-2
8.2.3	Measuring Transducer with PWM Outputs.....	8-2

---

8.3	Frequency Measurement on High Speed Counter Inputs .....	8-2
<b>9</b>	<b>INTERRUPTS</b>	<b>9-1</b>
9.1	Input Interrupts .....	9-1
9.2	Periodic Timer Interrupt (PTI) .....	9-2
9.3	Power Failure Interrupt (PFI) .....	9-3
<b>10</b>	<b>STEPPER MOTOR CONTROL</b>	<b>10-1</b>
10.1	Technical Specifications:.....	10-1
10.2	Nano-10 As Stepper Motor Controller .....	10-1
10.2.1	Interfacing to 5V Stepper Motor Driver Inputs .....	10-2
10.3	Programming Stepper Control Channel .....	10-3
10.3.1	Introduction.....	10-3
10.3.2	Setting the Acceleration Properties.....	10-3
10.3.3	Using the STEPMOVE Command .....	10-3
10.3.4	Using the STEPMOVEABS Command .....	10-4
	Example: .....	10-5
10.3.5	Demo Program for Stepper Motor Control .....	10-5
<b>11</b>	<b>PULSE WIDTH MODULATED OUTPUTS</b>	<b>11-1</b>
11.1	Introduction .....	11-1
11.2	Nano-10 PLC PWM Outputs.....	11-1
11.3	Increasing Output Drive Current (Opto-Isolated).....	11-2
11.4	Position Control Of RC Servo Motor .....	11-3
11.4.1	Using Nano-10 PWM Output To Control RC Servo (Non-Isolated) .....	11-4
11.4.2	Using Nano-10 PWM Output To Control RC Servo (Opto-Isolated) .....	11-5
11.4.3	RC Servo Positioning Resolution .....	11-5
<b>12</b>	<b>REAL TIME CLOCK</b>	<b>12-1</b>
12.1	Introduction .....	12-1
12.2	TBASIC variables Used for Real Time Clock .....	12-1
12.3	RTC Error Status On Ladder Logic .....	12-1
12.4	Setting the RTC Using TRiLOGI Software.....	12-2
12.5	Setting the RTC from Internet Time Server .....	12-3
12.6	Setting up an Alarm Event in TBASIC.....	12-3
12.7	Retrieving RTC Clock values using STATUS (18) .....	12-3
12.8	RTC Calibration (For FRAMRTC only) .....	12-4
12.9	Control of RTC Hardware.....	12-5
12.10	Troubleshooting the FRAMRTC .....	12-5
<b>13</b>	<b>LCD DISPLAY PROGRAMMING</b>	<b>13-1</b>
13.1	SETLCD Command .....	13-1
13.2	Special Commands For LCD Display.....	13-1

---

13.3	Displaying Numeric Variable With Multiple Digits.....	13-2
13.4	Displaying Decimal Point.....	13-3
<b>14</b>	<b>SERIAL COMMUNICATIONS</b>	<b>14-1</b>
14.1	Introduction:.....	14-1
14.2	COMM1: Two-wire RS485 Port.....	14-1
14.2.1	PROGRAMMING AND MONITORING .....	14-1
14.2.2	Accessing 3 <sup>rd</sup> Party RS485-based Devices.....	14-2
14.2.3	Interfacing Other Devices to Modbus/TCP Host or to the Internet.....	14-2
14.2.4	Distributed Control.....	14-2
14.3	Changing Baud Rate and Communication Formats: Use of the SETBAUD Statement .	14-2
14.4	Support of Multiple Communication Protocols .....	14-4
14.5	Accessing the COMM Port from within TBASIC .....	14-5
14.6	Using The PLC As a Modbus / Omron Slave – SCADA, HMI Applications.....	14-7
14.6.1	MODBUS ASCII Protocol Support .....	14-7
14.6.1.1	BIT ADDRESS MAPPING FROM A MODICON / MODBUS DEVICE.....	14-9
14.6.1.2	WORD ADDRESS MAPPING .....	14-10
14.6.2	MODBUS RTU Protocol Support .....	14-10
14.6.3	OMRON Host Link Command Support .....	14-11
14.6.4	Application Example: Interfacing to SCADA Software .....	14-11
14.7	Using The PLC As a Modbus Master – Getting Data From Power or Flow Meters ...	14-13
14.7.1	Nano-10 PLC As MODBUS RTU Master .....	14-13
<b>15</b>	<b>HOST LINK PROTOCOL INTRODUCTION</b>	<b>15-1</b>
15.1	Multiple Communication Protocols .....	15-1
15.2	Native Mode Communication Protocols.....	15-1
15.3	Point-To-Point Communication Format .....	15-1
15.3.1	Command/Response Frame Format (Point to Point) .....	15-2
15.3.2	Error Response Format.....	15-2
15.4	MULTI-POINT COMMUNICATION SYSTEM .....	15-3
15.4.1	Command/Response Frame Format (Multi-point) .....	15-3
15.4.2	Calculation of FCS .....	15-4
15.4.3	Communication Procedure.....	15-4
15.4.4	Framing Errors .....	15-5
15.4.5	Command Errors.....	15-5
15.4.6	SHOULD YOU USE POINT-TO-POINT OR MULTI-POINT PROTOCOL? .....	15-5
15.5	RS485 Primer.....	15-6
15.5.1	RS485 Network Interface Hardware .....	15-6
15.5.2	Protection of RS485 Interface .....	15-6
15.5.3	Single Master RS485 Networking Fundamentals .....	15-7
15.5.4	Multi-Master (Peer-to-Peer) RS485 Networking Fundamentals .....	15-8
15.5.4.1	Multiple Access with Collision Detection .....	15-8
15.5.4.2	Token Awarding Scheme.....	15-9
15.5.4.3	Rotating Master Signal.....	15-9
15.5.5	TROUBLE-SHOOTING AN RS485 NETWORK .....	15-9
<b>16</b>	<b>HOST LINK PROTOCOL FORMAT</b>	<b>16-1</b>
16.1	Device ID Read.....	16-1



---

<b>16.2</b>	<b>Device ID Write</b> .....	<b>16-1</b>
<b>16.3</b>	<b>Read Digital Input Channels</b> .....	<b>16-1</b>
16.3.1	Definition of Input Channels .....	16-2
<b>16.4</b>	<b>Read Digital Output Channels</b> .....	<b>16-2</b>
<b>16.5</b>	<b>Read Internal Relay Channels</b> .....	<b>16-3</b>
16.5.1	Definition of Internal Relay Channel Numbers .....	16-3
<b>16.6</b>	<b>Read Timer Contacts</b> .....	<b>16-4</b>
16.6.1	Definition of Timer-Contact Channel Numbers .....	16-4
<b>16.7</b>	<b>Read Counter Contacts</b> .....	<b>16-4</b>
16.7.1	Definition of Counter-Contact Channel Numbers:.....	16-4
<b>16.8</b>	<b>Read Timer Present Value (P.V.)</b> .....	<b>16-5</b>
<b>16.9</b>	<b>Read Timer Set Value (S.V.)</b> .....	<b>16-5</b>
<b>16.10</b>	<b>Read Counter Present Value (P.V.)</b> .....	<b>16-5</b>
<b>16.11</b>	<b>Read Counter Set Value (S.V.)</b> .....	<b>16-6</b>
<b>16.12</b>	<b>Read Variable - Integers (A to Z)</b> .....	<b>16-6</b>
<b>16.13</b>	<b>Read Variable - Strings (A\$ to Z\$)</b> .....	<b>16-6</b>
<b>16.14</b>	<b>Read Variable - Data Memory (DM[1] to DM[4000])</b> .....	<b>16-7</b>
<b>16.15</b>	<b>Read Variable - System Variables</b> .....	<b>16-7</b>
<b>16.16</b>	<b>Read Variable - High Speed Counter HSCPV[ ]</b> .....	<b>16-8</b>
<b>16.17</b>	<b>Write Inputs</b> .....	<b>16-8</b>
<b>16.18</b>	<b>Write Outputs</b> .....	<b>16-9</b>
<b>16.19</b>	<b>Write Relays</b> .....	<b>16-9</b>
<b>16.20</b>	<b>Write Timer-contacts</b> .....	<b>16-9</b>
<b>16.21</b>	<b>Write Counter-contacts</b> .....	<b>16-9</b>
<b>16.22</b>	<b>Write Timer Present Value (P.V.)</b> .....	<b>16-10</b>
<b>16.23</b>	<b>Write Timer Set Value (S.V.)</b> .....	<b>16-10</b>
<b>16.24</b>	<b>Write Counter Present Value (P.V.)</b> .....	<b>16-10</b>
<b>16.25</b>	<b>Write Counter Set Value (S.V.)</b> .....	<b>16-11</b>
<b>16.26</b>	<b>Write Variable - Integers (A to Z)</b> .....	<b>16-11</b>
<b>16.27</b>	<b>Write Variable - Strings (A\$ to Z\$)</b> .....	<b>16-11</b>
<b>16.28</b>	<b>Write Variable - Data Memory (DM[1] to DM[4000])</b> .....	<b>16-12</b>
<b>16.29</b>	<b>Write Variable - System Variables</b> .....	<b>16-12</b>
<b>16.30</b>	<b>Write Variable - High Speed Counter HSCPV[ ]</b> .....	<b>16-13</b>
<b>16.31</b>	<b>Halting the PLC</b> .....	<b>16-13</b>
<b>16.32</b>	<b>Resume PLC Operation</b> .....	<b>16-13</b>
<b>16.33</b>	<b>Read Analog Input</b> .....	<b>16-13</b>
<b>16.34</b>	<b>Read EEPROM Integer Data</b> .....	<b>16-14</b>
<b>16.35</b>	<b>Read EEPROM String Data</b> ( <i>r47 Firmware Only</i> ) .....	<b>16-14</b>

---

<b>16.36</b>	<b>Write Analog Output .....</b>	<b>16-15</b>
<b>16.37</b>	<b>Write EEPROM Integer Data .....</b>	<b>16-15</b>
<b>16.38</b>	<b>WRITE EEPROM String Data .....</b>	<b>16-16</b>
<b>16.39</b>	<b>Force Set/Clear Single I/O Bit .....</b>	<b>16-16</b>
<b>16.40</b>	<b>Using OMRON Host Link Commands .....</b>	<b>16-17</b>
16.40.1	Read IR Registers .....	16-17
16.40.2	WRITE IR Registers .....	16-18
16.40.3	Read Data Memory DM[1] to DM[4000] .....	16-18
16.40.4	WRITE Data Memory DM[1] to DM[4000] .....	16-19
<b>16.41</b>	<b>Testing of Host Link Commands .....</b>	<b>16-20</b>
<b>16.42</b>	<b>Visual Basic Sample Program .....</b>	<b>16-21</b>
<b>16.43</b>	<b>Inter-PLC Networking Using NETCMD\$ Command .....</b>	<b>16-21</b>
<b>16.44</b>	<b>Inter PLC Networking Using MODBUS Protocols .....</b>	<b>16-21</b>
<b>17</b>	<b>I<sup>2</sup>C COMMUNICATION .....</b>	<b>17-1</b>
<b>17.1</b>	<b>The I2C-FRTC Module .....</b>	<b>17-1</b>
17.1.1	Installing the I2C-FRTC Module .....	17-1
17.1.2	I2C-FRTC Hardware Overview .....	17-2
17.1.3	I2C-FRTC Availability .....	17-2
<b>17.2</b>	<b>New TBASIC Commands: I2C_READ, I2C_WRITE and I2C_STOP .....</b>	<b>17-2</b>
17.2.1	I2C_WRITE .....	17-3
17.2.2	I2C_READ .....	17-4
17.2.3	I2C_STOP .....	17-6
17.2.4	Random Write To M24M01 EEPROM .....	17-6
17.2.5	Page Write To M24M01 EEPROM .....	17-6
17.2.6	Random Read From M24M01 EEPROM .....	17-7
17.2.7	Sequential Read From M24M01 EEPROM .....	17-8
<b>18</b>	<b>EXTENDED FILE SYSTEM .....</b>	<b>18-2</b>
<b>18.1</b>	<b>Introduction .....</b>	<b>18-2</b>
<b>18.2</b>	<b>File Structure and File Naming of The Extended File System .....</b>	<b>18-3</b>
<b>18.3</b>	<b>Transferring Files To The PLC's Web Server .....</b>	<b>18-4</b>
<b>18.4</b>	<b>Accessing The Extended Data Files Using TBASIC .....</b>	<b>18-4</b>
18.4.1	Open A File For Writing New Data .....	18-4
<b>18.5</b>	<b>Open A File For Appending Data To The End Of The File .....</b>	<b>18-5</b>
18.5.1	Delete A File .....	18-5
18.5.2	Open A File For Reading .....	18-5
<b>18.6</b>	<b>Setting Up The FileZilla FTP Server .....</b>	<b>18-7</b>
18.6.1	Download and Setup FTP Server .....	18-7
18.6.2	Testing Connection To The FTP Server Using Telnet .....	18-9
<b>18.7</b>	<b>Uploading File From PLC to FileZilla FTP Server Directory .....</b>	<b>18-12</b>
18.7.1	Overview of The FTP Protocol .....	18-12
18.7.2	PLC FTP Upload Procedure .....	18-12
18.7.3	Monitoring The FTP Upload Progress .....	18-13
<b>18.8</b>	<b>Setting Up A FTP Server Behind a Windows Firewall .....</b>	<b>18-14</b>

<b>19</b>	<b>USING PLC AS A MODBUS/TCP GATEWAY</b>	<b>19-1</b>
19.1	Introduction .....	19-1
19.2	Application Ideas for Modbus/TCP Gateway .....	19-1
19.3	Configuring The PLC As Modbus/TCP Gateway .....	19-1
19.4	Fine-Tuning The Modbus/TCP Gateway Function .....	19-2
19.5	Modbus/TCP Gateway Sample Program .....	19-3

# **Chapter 1      Installation Guide for Nano-10 PLC**

# 1 INSTALLATION GUIDE FOR NANO-10 PLC

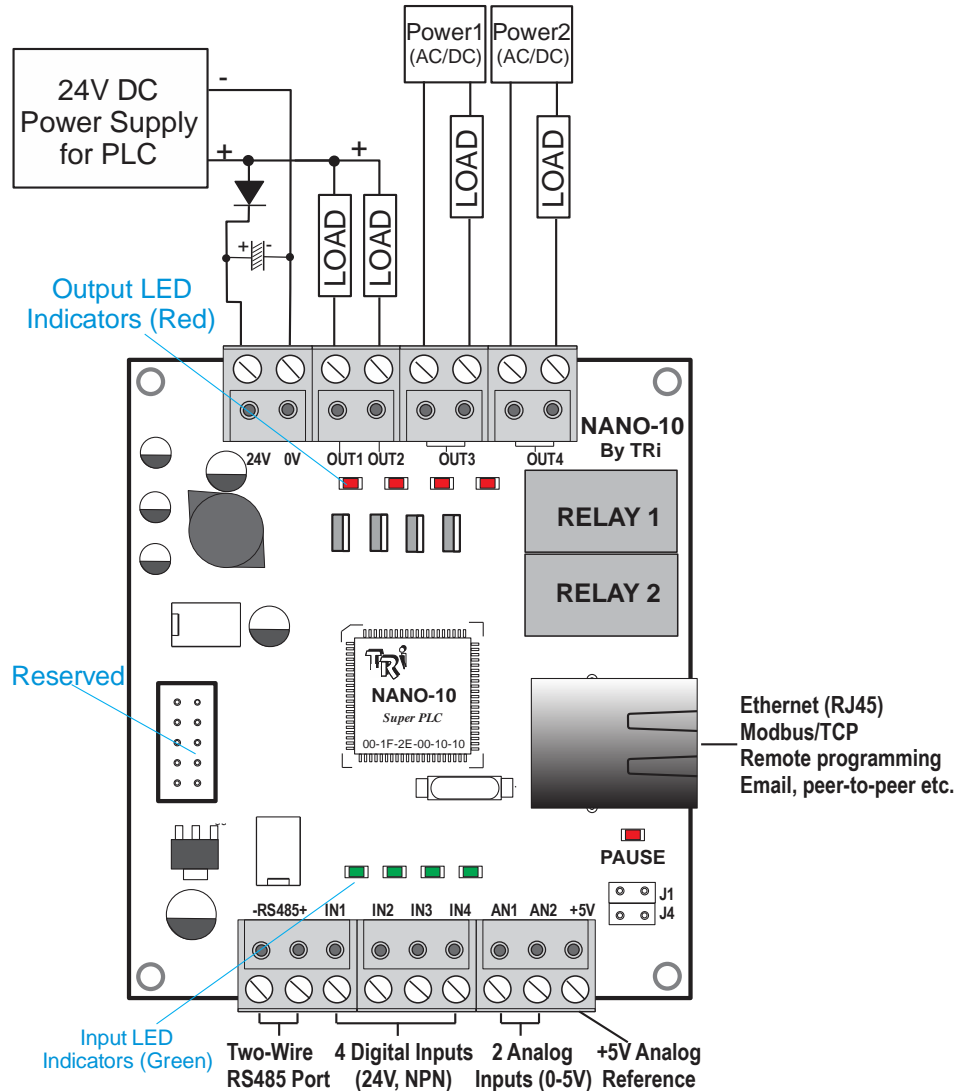

Figure 1.1

## 1.1 Overview

The new TRI's Nano-10 is quite possibly the world's most powerful Nano-class PLC! Although measuring only 2.75" x 3.25" and spots just 10 digital+analog I/Os, it comes with a built-in Ethernet port that can be connected directly to a network router, switch, or hub for access to the LAN or to the Internet. The Ethernet port supports the FServer (for remote programming or monitoring) and a Modbus/TCP server (for access by third party devices) with up to 10 simultaneous connections. The user can also easily program the Nano-10 to connect to another PLC (peer-to-peer networking) or to Modbus/TCP slave devices via the Internet. It can email real time data to any email address(es), or connect to the Internet Time Server to get the most accurate real time information.

The Ethernet port also supports "Web Services", allowing enterprise software, such as a database program or MS Excel, to query for information from multiple PLCs instantaneously. This also means that

you can even create your own Ajax based web page to monitor/control your PLC using an internet browser on a smart phone such as the Apple's i-Phone or just about any PC/Mac browser! An example template will be provided to demonstrate this ability and you can easily modify the template to create the web page that is specific to your own application.

The Nano-10 PLC comprises 2 analog inputs (12-bit, 0-5VDC), 4 digital Inputs, and 4 digital outputs. 2 of the digital outputs (1 and 2) can each sink up to 4A peak and 2A continuous, 24VDC current from the load and can be used to output stepper motor pulse/direction signals, or used as Pulse-Width Modulated (PWM) output driver. The other 2 digital outputs each comprises a pair of voltage-free contacts, allowing switching of two isolated loads of up to 5A current per channel (24VDC/AC or 120VAC).

In addition, all 4 of the digital inputs can be used for decoding and measuring pulses received from up to 2 digital encoders, allowing you to measure position and velocity of 2 moving objects in real time. All 4 of the digital inputs can also be defined as interrupt inputs, allowing fast events to be handled in the shortest possible time and to not be constrained by the program scan time.

The Nano-10 built-in RS485 port allows it to interface to many peripheral devices such as an LCD display (e.g. MDS100-BW <http://www.tri-plc.com/mds100bw.htm>) or a serial touch panel (e.g. Maple System HMI). The RS485 port is conversant in MODBUS protocol and can be used as a MODBUS master or slave to construct a highly sophisticated control system. You can also use it to interface to bar-code readers, serial printers, RFID readers, or use it for programming/monitoring via the TLServer software (part of the i-TRiLOGI software suite).

The Nano-10's RS485 port is also the only means to communicate with the Nano-10 CPU if your Ethernet configuration settings are corrupted and it cannot be connected to your network router.

## 1.2 Physical Mounting & Wiring

The Nano-10 can be easily installed in many kinds of plastic or metal enclosures. You need to use 4 PCB standoffs (or screws and nuts) to support the controller and fasten it to a console box. Alternatively, you can mount it on the optional "DIN-KIT 1B" and clip it onto the standard DIN rail.

The following subsections show some hardware details of the I/Os that are available on the Nano-10 PLC model. Separate chapters in this manual will be devoted to discussing the programming methods for this hardware.

### 1.2.1 Digital Inputs, Analog Input and RS485 Communication Ports

The two-wire RS485 port, 4 digital inputs and 2 analog inputs as well as a +5V analog reference voltage are all available on a bank of screw terminal blocks along the lower edge of the PLC:

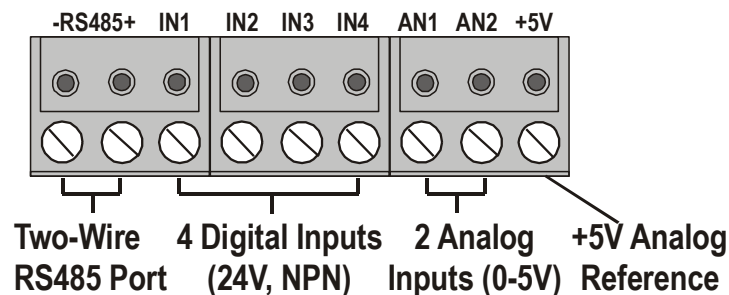

Figure 1.2

Please refer to Section 1.4 regarding the specifications of the Digital Inputs. The specifications and programming methods for the analog inputs are detailed in [Chapter 5](#) of this manual. [Chapter 14](#) describes the use of the RS485 serial communication port.

Note that the screw terminal block is actually detachable from its soldered pins to the PCB, which permits easy replacement of the controller board when necessary, as shown below:

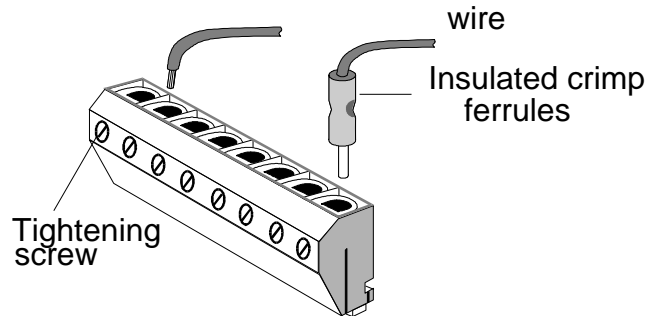
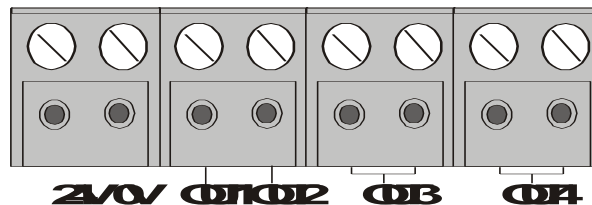

Figure 1.3 – Using Ferrules to connect to screw terminal block

Although wires may be connected directly to the screw terminal, insulated crimp ferrules should be used to provide a good end termination to multi-stranded wires. Use of ferrules reduces the possibility of stray wire strands short-circuiting adjacent terminals and their use is, therefore, highly recommended.

## 1.2.2 Power Supply and Digital Output Ports

The Nano-10 power supply and 4 digital outputs are available on the detachable screw terminal block along the top edge of the Nano-10 PCB:



The following sections describe the specifications of the PLC power supply as well as digital I/Os.

## 1.3 Power Supply

The Nano-10 PLC requires a single regulated, 24V (+/- 5% ripple) DC power supply. The PLC typically consumes less than 100mA and thus you may also use the same power supply to power the PLC and a small output load, as long as the total load current is within the power supply maximum limit.

If the loads require higher current, then it is recommended that a separate power supply be used for the output load. Note that if you choose to use two separate power supplies for non-isolated output (#1 and #2), their 0V terminals should be tied together to provide a common ground reference for the two power supplies.

The two power supplies are also recommended to be of the same output voltage. Otherwise, if the voltage of the load power is lower than the voltage of the CPU power, the output LED will light up even when the

output driver is not energized. This is because the current could flow out of the PLC's output into the (lower voltage) load power supply and therefore light up the LED. This can be very confusing to users even though it should not damage the LED. Should this happen, you will need to add a series diode to the output terminal to block the output LED currents from flowing through the load and back to the load power.

Please use only an industrial grade linear or switching regulated power supply from established manufacturers. Using a poorly made switching power supply can give rise to a lot of problems if the noisy high frequency switching signals are not filtered properly.

**Note:** If your application demands very stable analog I/Os you should choose a linear power supply instead of a switching power source for the CPU.

Always place the power supply as close to the PLC as possible and use a separate pair of wires to connect the power to the PLC. Keep the power supply wires as short as possible and avoid running them along side high current cables in the same cable conduit. The Nano-10 PLC will enter a shut down procedure when the power supply voltage dips below approximately 16V. It is a good idea to connect a 470 $\mu$ F to 1000 $\mu$ F, 50V electrolytic capacitor near the power supply connector to suppress any undesirable voltage glitches from conducting into the PLC. If other high current devices, such as a frequency inverter, were to affect the operation of the PLC, you should then also connect a diode before the capacitor to prevent reverse current which might flow back to the power supply, as shown in the following diagram:

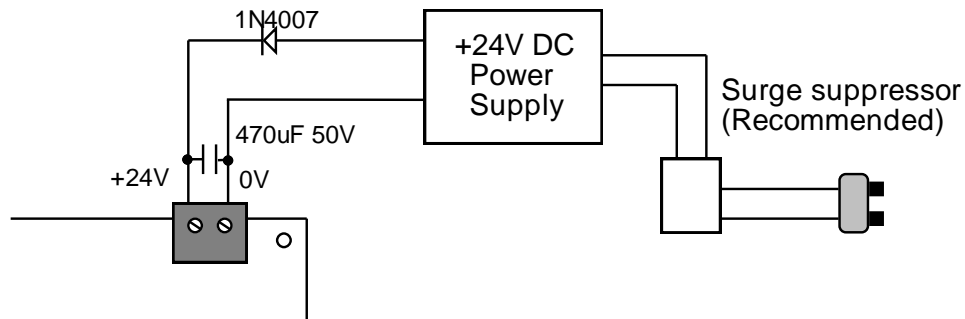

Figure 1.4

If the AC main is affected by nearby machines drawing large amounts of current (such as large three-phase motors), you should use a surge-suppressor to prevent any unwanted noise voltage from being coupled into the Nano-10 power supply. The required current rating for the power supply depends mainly on the total output current, taking into consideration the peak current demand and the duty cycle of the operation.

## 1.4 Digital Input Circuits

All 4 digital inputs are NPN type (with green colored LED indicators), meaning that to turn ON an input, you should connect it to the low-voltage rail (0V terminal) of the power supply as shown in the following diagram. The input numbers are marked on the PCB alongside the side of the screw terminal block.

All digital inputs are directly programmable in Ladder Logic, as well as in TBASIC custom functions. Some **programming examples** are detailed in [“Chapter 3 –Digital I/Os and Internal Relays”](#)



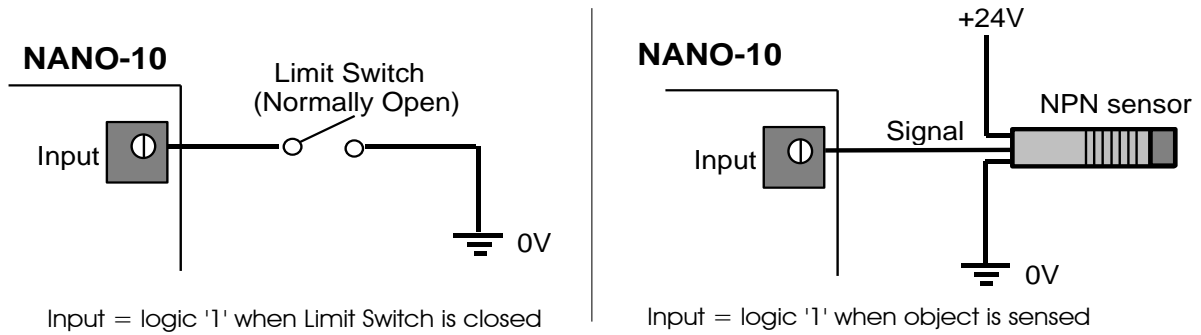

Input Voltage for <b>Logic 0</b> :	Open Circuit or +10V to +24VDC
Input Voltage for <b>Logic 1</b> :	0V to +2.5V DC

Figure 1.5 –Interfacing to Limit Switch and NPN Sensor

## 1.5 Digital Output Circuits

### 1.5.1 Electrical Specifications:

	Output #1 & 2	Output #3 & 4
Output Driver type	NPN Darlington Transistors	Voltage-free Contacts (Isolated pair per output)
Maximum Breakdown Voltage	55V	1000V RMS (1 min)
Maximum Output Current:	4A	5A @24V/120VAC 2A @ 250VAC
Continuous Output Current	2A	5A @24V/120VAC 2A @ 250VAC
Output Voltage when OFF	Resistor pulled up to 24V power rail	None
Output Voltage when ON:	0.2V @2A	0V @2A
Inductive Back EMF Bypass	Yes (Intrinsic Zener @55V)	None

All outputs have red colored LED indicators. The Nano-10 PLC employs “sinking” (NPN) type power MOSFET on its two solid state output #1 and #2 that turn ON by sinking current from the load to the 0V terminal.

**Note:** Output #1 and #2 can also be configured as

- 1) **PWM outputs** to drive heating elements or proportional valves using the SETPWM command – please see [Chapter 11](#) for more information.
- 2) **Stepper Motor Controller:** to send pulse and direction signals to an external stepper motor driver in order to control motion of a stepper motor. See [Chapter 10](#) for more details.

## 1.5.2 Digital Output Wiring Diagram

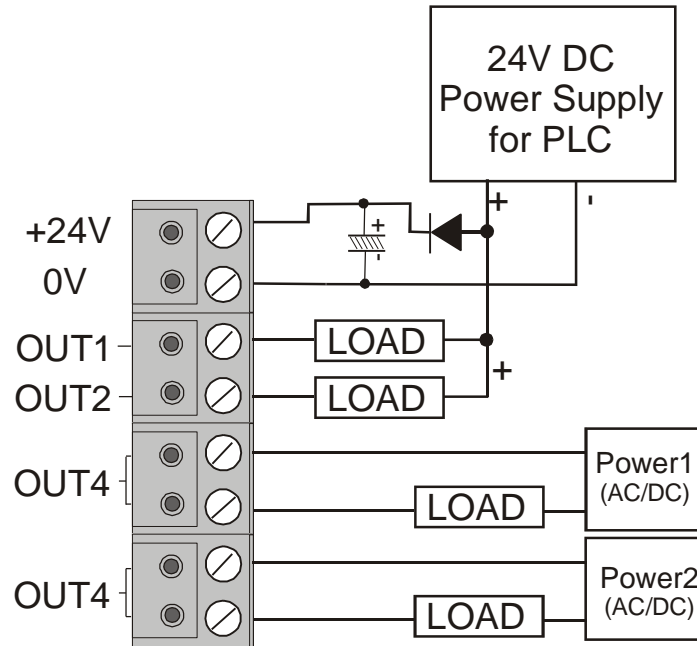

Figure 1.6 – Nano-10 Output Interfacing to Load

All digital outputs are directly programmable in Ladder Logic as well as in TBASIC custom functions. Some **programming examples** are detailed in "[Chapter 3 –Digital I/Os and Internal Relays](#)". Note that it is possible to wire the four outputs to become a H-bridge (relay outputs #3 and #4 as high side switch and MOSFET output #1 and #2 as low side switch), which can drive a DC motor in both forward and reverse directions. You can even use the PWM outputs to control the speed of the motor and therefore make it possible to use the Nano-10 as an internet-accessible, bi-directional motor speed controller!

## 1.5.3 Inductive Load

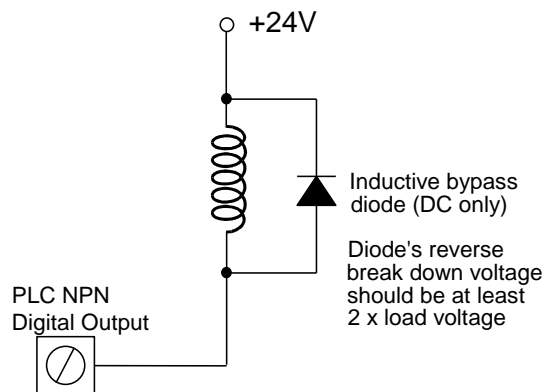
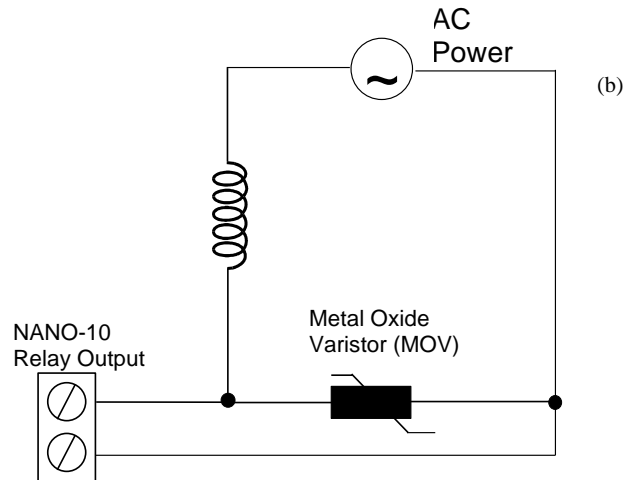

Figure 1.7

When switching inductive loads such as a solenoid or a motor, always ensure that a bypass diode is connected to absorb inductive kicks, which will occur whenever the output driver is turned OFF. Although Output #1 and #2 already incorporate intrinsic Zener bypass diodes to protect the driver, it only activates when the inductive kick voltage rises above the maximum breakdown voltage (about 55VDC). This could

result in a large dose of noise being introduced into the system and may have undesirable effects. For DC we recommend using a fast recovery diode such as UF4001 to UF4007 connected as shown in the above diagram to absorb the inductive noise.

For AC loads (output #3 & #4) you'll need to select a suitable Metal Oxide Varistor (MOVs) to protect the relay contacts, as shown below:



## 1.6 Program and Data Memory

	Default Configuration	With FRAM-RTC Add On
Program Memory	8000 words*	16000 words
Non-Volatile Data Storage Integers (16-bit) Strings (40 chars max)	1024 words 51	11000 words 549
RAM Data Memory DM A to Z (32-bit) A\$ to Z\$ (70 chars string) EMINT[], EMLINT[], EMEVENT[]	1000 words (volatile) Yes (volatile) Yes (volatile) Yes (volatile)	4000 (non-volatile) Yes (J1:non-volatile) Yes (J1:non-volatile) Yes (volatile)

\* Each word is 16-bit (two bytes)

### 1.6.1 Program Memory

Standard Nano-10 PLC can store up to 8000 (16-bit) words of program memory stored in the CPU Flash memory area. This can be expanded to 16,000 words with the addition of an optional FRAM-RTC module.

Each ladder logic element (contacts or coils) takes up 1 word of memory. A TBASIC statement or function takes up half a word to four or five words, depending on the number of parameters the statement or function has.

The program memory can be erased and reprogrammed more than one hundred thousand times, which is a limit that you are unlikely to ever reach. However, unlike on the T100M+ PLCs, the program memory of the Nano-10 is not stored in an easily removable IC, so it is not possible to upgrade your customer's PLC program by swapping out a single IC (such as the M2017P or M2018P on a T100M+ PLC).

## 1.6.2 Non-Volatile Data Storage

Users of the M-Series PLCs (T100MD+ and T100MX+ PLCs) may be familiar with the PLCs' EEPROM memory as well as some of its limitations. Standard Nano-10 PLC does not have any built-in EEPROM on board. An optional [FRAMRTC](#) module can be added to the Nano-10 to provide up to 11K words of non-volatile, high-speed ferromagnetic memory that behave just like EEPROM to the PLC.

However, if you have only limited use of the EEPROM memory say to store some non-volatile parameters once in a while, and you do not wish to incur the expense of buying the FRAMRTC module, then you will be glad to learn that the Nano-10 CPU cleverly uses its static RAM to shadow a flash memory area in the CPU to provide up to 1024 words of "pseudo EEPROM", that allows user to read and write to/from these memory using the standard TBASIC SAVE\_EEP, LOAD\_EEP, SAVE\_EEP\$, LOAD\_EEP\$ commands.

The pseudo EEPROM data are normally stored in static RAM memory. This implies you can read/write to the pseudo EEPROM at full speed with no limitation to the read/write life of the pseudo EEPROM area since these are actually just RAM memory. However, since data stored in RAM are volatile, they need to be saved into the non-volatile flash memory before power down. Nano-10 allows you to do so easily using a single SETSYSTEM command, as follow:

```
SETSYSTEM 252, 0
```

Upon execution of the above command, the Nano-10 CPU will erase a special flash memory area used to backup the pseudo EEPROM and it will then copy the entire pseudo EEPROM memory data to the flash memory. However, the CPU will perform the backup only if there are any changes made to the pseudo EEPROM area. This is to prevent unnecessary erase/write of the flash memory.

It is the responsibility of the programmer to determine when and how often to run the abovementioned SETSYSTEM command before power to the Nano-10 is removed in order not to lose data. The reason why the programmer should not backup the pseudo EEPROM space to the flash memory every time a data has changed is because (a) The backup process can take tens of millisecond to complete. (b) the backup involves erasing the flash sector and burning the new data into the flash sector, and the flash memory does have a write cycle life of only about 100,000 cycles which should not be exceeded.

**Note:** The CPU will also automatically backup the pseudo EEPROM memory to the flash memory whenever the PLC executes a software reset or reboot, or if the PLC is reset or rebooted via the serial or Ethernet communication.

Upon power up, the CPU automatically loads the data from the flash memory into all the pseudo EEPROM memory and therefore this memory can be used just like the standard EEPROM data memory in the M-series and the F-series PLCs.

**Important:** If the PLC program runs any of the following commands: SETIPADDR, SETTIMERSV, SETCTRSV, the command should also be followed by the SETSYSTEM 252, 0 command (or a RESET command) at least once before the power to the PLC is turned off to ensure that the new parameters are written to the flash memory (separate memory location from the data memory mentioned above). In the case of SETIPADDR command, the new IP address only take effect after a REBOOT or power on reset.

### Automatic Backup Using Power Failure Interrupt

On a Nano-10 PLC, an onboard power failure detection circuit detects a power failure when the power supply voltage drops below approximately 16V, and you can setup the PLC to execute a user's defined power failure interrupt custom function. It is therefore tempting (and indeed possible) to include the SETSYSTEM 252,0 function inside the power failure interrupt custom function to automatically backup the pseudo EEPROM data during power failure. This is actually possible provided you are using a good power supply that provides a gradual decay of supply voltage during power down.

This is because the process of backing up the shadow RAM to the flash memory as well as executing other user's power failure interrupt service routine would require an execution time of at least tens of milliseconds. It is therefore very important for the power supply voltage to the PLC to gradually decrease to zero over several hundred milliseconds during power down. I.e. a nice power down voltage gradient is required. This ensures that the CPU has sufficient time before it loses its operating voltage required for it to properly backup the pseudo EEPROM data to the flash memory.

If you simply cut off the DC voltage to the PLC (e.g. by disconnecting the power supply terminal to the PLC abruptly), then what could happen is that the PLC may only have time to **erase** the flash memory sector for backing up the pseudo EEPROM, but does not have enough time to backup the pseudo EEPROM data to the flash memory. The result could be loss of all the EEPROM data when the power is returned to the PLC. (You will know that the backup area of the EEPROM has been erased but not re-written if all the EEPROM data reads only -1 upon power up).

The additional diode and 470uF (or larger) capacitor connected to the PLC's power supply input screw terminal as shown in Figure 1.4 (also shown below) would also help to obtain a good voltage decay gradient during power down, and is therefore highly recommended if you need to execute any power failure interrupt service routines.

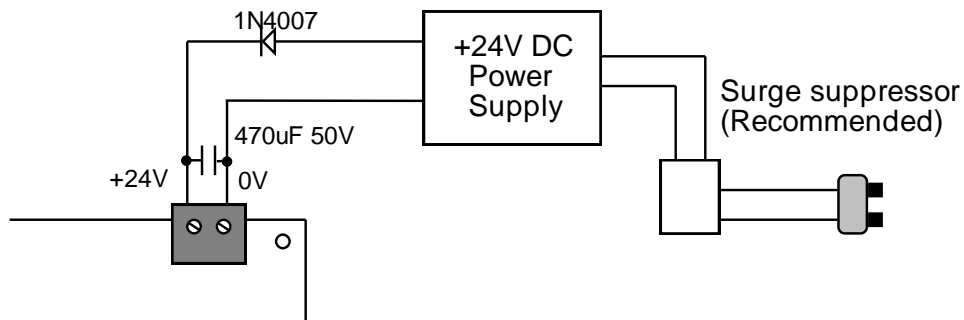

To ensure that the power supply provides a slow voltage gradient during power down, the power switch must be connected to the AC side of the power supply instead of to the DC side of the power supply. All industrial DC power supplies usually have large filtering capacitors at the DC output, which means that the power supply to the load would normally decrease slowly when power supply to the AC side has been cut.

**Note:** if the user intends to execute the SAVE\_EEP or SAVE\_EEP\$ commands during power failure, then these commands must be executed BEFORE executing the SETSYSTEM 252, 0 command so that they can be backed up to the flash memory.

### FRAMRTC Based Non Volatile Memory

The optional FRAMRTC module provides a large array of state-of-the-art Ferromagnetic RAM (FRAM) memory to the Nano-10 PLC, and these FRAM memories will be used as primary storage for the user's EEPROM data. With FRAMRTC the PLC would have a total of 11,000 words of all FRAM-based EEPROM memory. These 11000 words of EEPROM data can also be used to store up to 549 strings of 40 characters per string.

Since these FRAM are truly non-volatile and they do not have to be backed up to any flash memory, the data are therefore not easily corrupted by any unplanned power disruptions.

Also these FRAM memories allow an unlimited number of read and write cycles at full speed and they are thus much better than the traditional "EEPROM" memory on the M-series PLC. However, for legacy reasons we are still calling them EEPROM memory since they are to be accessed using the TBASIC's SAVE\_EEP, LOAD\_EEP, SAVE\_EEP\$ and LOAD\_EEP\$ commands.

### 1.6.3 RAM Data Memory

All the TBASIC variables used in the Nano-10 PLC: A to Z, DM[1] to DM[1000] and string A\$ to Z\$, EMINT[1] to EMINT[16] and EMLINT[1] to EMLINT[16] are normally stored in the CPU RAM area and therefore they fall into the category of “volatile data memory” - meaning when you turn off power to the PLC the memory content will be lost and they will be reset to zero when the PLC is powered up again. Hence, you should use the SAVE\_EEP command to save any data that must be preserved after the PLC is powered down.

Also note that in a standard Nano-10 PLC, only the first 1000 DM memory locations are available. This means that your program would not be able to access any DM beyond DM[1] to DM[1000]. Reading from DM[1001]-DM[4000] will always return 0 and writing to these address will be ignored.

#### With FRAM-RTC

With addition of the FRAM-RTC module, the amount of DM memory is increased to 4000 words, making it the same as those on standard T100M+ or F-series PLCs.

Also, since some FRAM memory area is reserved to store these variables, it is possible to make variables A to Z, A\$ to Z\$ and DM[1] to DM[4000] non-volatile by shorting Jumper J1 on the Nano-10 circuit board (see Section 1.7). This provides for additional non-volatile data storage to applications that need them.

## 1.7 Jumpers J1 & J4

Two jumpers, J1 and J4, are provided on the Nano-10 PLC in place of the DIP switches #1 & #4 that you may already be familiar with on the M and F-series PLCs. The two jumpers have the following functions when they are closed (i.e a jumper block is placed over the two pins to short them together):

Jumper	OPEN	CLOSE
J1	All RAM data memory are volatile	If FRAM-RTC is installed, then A to Z, A\$ to Z\$ and DM[1] to DM[4000] are non-volatile.
J4	Normal Run mode	Suspends execution of the ladder logic program. But host communication remains active.

### 1.7.1 Usefulness of Jumper J4

We have taken every effort to ensure that the host communication is always available even when the user-program ends up in a dead-loop. This allows the user to re-transfer a new program to the PLC and overwrite the bad program. However, you may still encounter a situation whereby after transferring a new program to the PLC, you keep encountering communication errors and you are unable to erase the bad program. This is especially common if you have been experimenting with the communication commands such as SETBAUD, SETPROTOCOL, PRINT or OUTCOMM. These commands may modify the communication baud rate, format, or protocol or set the PLC to send data out of a COMM port that conflict with i-TRiLOGI. In such cases, you can short the jumper J4 and perform a power-on reset for the PLC. The PLC will not execute the bad program that causes communication problems and you can then transfer a new program into the PLC to clear up the problem.

Note that when the PLC has been power-reset with Jumper J4 closed, the COMM1 (RS485) serial port will boot up with default baud rate and communication format of 38,400, 8,n,1. (This differs from the T100M+ PLC.)

## 1.8 Real Time Clock

The Nano-10 PLC has a built-in Real-Time clock (RTC) that keeps track of the time and date and can be used to trigger time-based events readily. However, on the standard Nano-10 there is no battery-backup of the RTC. This means that when the Nano-10 is powered up the real time clock is set to the factory default date of 2000/1/1 and time at 0:00:00.

On the other hand, if you have connected the Nano-10 PLC to the LAN, you can program the PLC to automatically access a time server on the Internet or on the local LAN upon power up. This means that the PLC is able to synchronize its time accurately to that of the atomic clock source that the Internet Time Server's are often based on. This technique is described in [Section 2.5](#)

### FRAM-RTC

As its name implies, the FRAM-RTC module adds a lithium battery-backed Real-Time Clock module to the Nano-10 PLC. The Nano-10 CPU automatically detects the presence of the FRAM-RTC module and will set its built-in RTC using the battery-backed RTC data in the FRAM-RTC module. The FRAM-RTC therefore is useful to applications that are not connected to the LAN or the Internet (to set the RTC) but requires non-volatile RTC to control time-based events.

When the FRAMRTC is present, the Nano-10 PLC also tries to take advantage of the FRAMRTC's more accurate real-time clock by updating its internal RTC every hour when the seconds and minutes both become zero. This can be optionally disabled by using the SETSYSTEM command described in [Chapter 12](#).

## 1.9 CPU Status Indicators

There is a single red LED indicator on Nano-10 board marked "PAUSE". This indicator will light up for about 0.5 seconds during power-on. Thereafter it should go off. The PAUSE indicator will be turned ON if one of the following has occurred:

1. The PLC's program is corrupted.
2. A PAUSE statement has been executed
3. The user halts the PLC by pressing the <P> key during On-Line Monitoring.
4. Jumper J4 is turned ON, which halts the program.
5. A run-time error has occurred.

If this light is ON, please connect the host computer running i-TRiLOGI to the PLC and run the "On-Line Monitoring" program. You will be informed of the reason that caused the PAUSE condition. Except for condition (1) and (4), you can release the PLC from the PAUSE state by clicking on the "Pause" button or by pressing the <P> key during "On-Line Monitoring". If the PLC's program is corrupted, then you must re-transfer your program to the PLC.

If a run-time error has occurred the PLC will halt at the CusFn where the error took place. If the programmer now executes the "On-Line Monitoring" command in I-TRiLOGI, the cause of the run-time error and the CusFn where the error occurred will be reported on TRiLOGI screen. Although the Nano-10 PLC does not have built-in LCD port, you will still be able to view the virtual LCD display on the Online Monitoring/View Variable screen that displays the cause of the runtime error and the function where it occurred.

The TBASIC simulator captures many possible run-time errors including out-of-range values, but in the Nano-10, only a few most important run-time errors are reported. The remaining errors are ignored. The following are the few run-time errors that will be reported in the Nano-10 PLC:

1. Divide By Zero
2. FOR-NEXT loop with STEP = 0!
3. Call Stack Overflow! Circular CALL suspected!
4. Illegal Opcode - Please inform manufacturer!
5. System Variable Index out-of-range: This is normally caused by using an unavailable subscript.  
E.g. DM[0], INPUT[-1], DM[5000], etc. Check the subscript value, especially if it contains a variable (e.g. DM[X], if X=0 this will lead to a runtime error).

All run-time errors should be identified and corrected before you proceed any further.



## Chapter 2 Ethernet Port

## 2 ETHERNET PORT

Incredibly, every Nano-10 PLC has a single, built-in 10/100 Base-T Ethernet port that does everything that its bigger brother, the F-series PLCs are designed to do.

You can easily connect the Nano-10 PLC to your network router, switch, or hub using the straight CAT-5 cable. When a connection is made, the yellow “Connection LED” on the RJ45 connector will light up, indicating that the PLC has been connected to the network router.

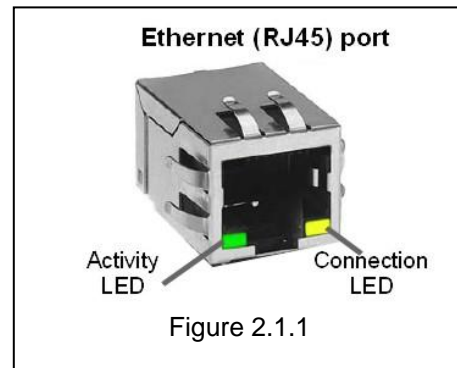

Once connected to the network, the i-TRiLOGI programming software works instantaneously with the PLC, allowing remote programming and process monitoring over the LAN or the Internet. In addition, the Ethernet facility at this port can host web pages and Java applets so that users of the equipment can control/monitor their equipment using their web browser from anywhere.

Before connecting the PLC's Ethernet port, you should configure it using the configuration tool that is now built into the 6.3x or higher version of the i-TRiLOGI programming software. Previously, a standalone Ethernet Configuration program was required to setup the basic and advanced Ethernet, ADC, and RTC (Real Time Clock) options. This standalone version is still available and more information on this program, including where to download it, is available at the end of section 2.1 ([2.14 Standalone Version of Ethernet Configuration Software](#)). Now these settings can be configured directly from the TRiLOGI programming software, as described next.

### 2.1 Configuring The Ethernet Port

This tool, which is located in the "Controller" Menu of TRiLOGI, allows you to configure the Ethernet Port and ADC/RTC calibration settings on a TRI's PLC with built-in Ethernet port, such as the Nano-10 and F-series PLCs. When the “Ethernet & ADC Calibration” is selected from the “Controller” menu, you will see the following screen:

The screenshot shows the 'Ethernet Configuration (BASIC)' dialog box. It contains the following fields and controls:

- IP Address: [Text Field]
- Subnet Mask: [Text Field]
- Gateway IP Addr: [Text Field]
- SMTP Server IP: [Text Field]
- DNS Server: [Text Field]
- FServer Port #: [Text Field]
- MBTCP Port #: [Text Field]
- LAN Speed: [Dropdown Menu, set to 100Mbps]
- Node Name: [Text Field, set to FServer]
- Number of Connections: [Text Field]
- Fserver:
- MBTCP:
- Use username/password?:  Yes  No
- Username: [Text Field]
- Password: [Text Field, masked with dots]
- AccessLevel: [Dropdown Menu, set to 1 - Programmer]
- Buttons: Factory Default, Retrieve Parameters from PLC, Save Parameters to PLC, Advanced Config., Close, Help, Reboot PLC after Save (checked).

The configuration program communicates with the PLC the same way as i-TRiLOGI, which is either through the TLServer software + serial port, or directly through the Ethernet Fserver port.

If your i-TRiLOGI is not yet connected to the TLServer software or directly to the PLC's built-in F-Server, then you will be prompted to login to the PLC's server.

(See the [i-TRiLOGI Programmers Reference Manual](#) for more information on this)

Figure 2.1.2

### Notes to New Users

If this is the first time that you are configuring the PLC's Ethernet port, and if your PC is not on the same default subnet of 192.168.1.xxx as the Nano-10, then you may not be able to communicate with the Nano-10 Ethernet port using its default IP address of 192.168.1.5:9080. In that case you can only communicate with the Nano-10 PLC through a serial port connection, until you have changed the PLC's IP address to match that of your network's address.

However, In order to communicate with the Nano-10 PLC via serial port connection, you will need to run the TLServer software on your PC. TLServer acts as a serial-to-Ethernet gateway such that the commands it receives from I-TRiLOGI software via TCP/IP are conveyed to the PLC via the PC's serial port, and *vice versa*

Since the Nano-10 PLC only has 1 RS485 serial port, this will require that the PC running TLServer to have an RS485 interface. However, most new PCs today no longer have any built-in serial port. Thus, the easiest way to install an RS485 interface on the PC is to purchase a USB to RS485 converter (e.g. <http://www.tri-plc.com/U-485.htm>). Since the USB toRS485 converter is powered by USB port, you can simply plug the converter into the PC's USB port and connect two wires to the Nano-10's RS485 port and immediately communicate with the PLC via serial communication.

Before you make any changes to the PLC's Ethernet configuration parameters, it is a good idea to retrieve the current settings. You can do this by clicking on the "Retrieve Parameters from PLC" button and answer "Yes" when prompted.

After you have retrieved the existing parameters from the PLC, you will see that various fields in the configuration software screen are filled up. The following sections describe the significance of each field.

**Important:** If you make changes to any of these fields, you must select the "Reboot PLC After Save" checkbox before clicking the "Save Parameters to PLC button" so that the new parameters will be saved to the flash memory of the PLC and the new parameter can take effect immediately.

Note that the Nano-10 PLC has two built-in "Server" programs that listen on a few different ports on the PLC for incoming TCP/IP request packets:

- 1) The FServer supports the TRi proprietary programs such as the i-TRiLOGI software and TRi-ExcelLink program. By default the FServer listens on the default port 9080.
- 2) A MODBUS/TCP server that listens on port #502 and supports the industry standard MODBUS/TCP protocols.

**Note:**

- These two servers share the same Ethernet port and therefore the same IP address and gateway addresses described in the following sections.
- Nano-10 PLCs host both the FServer and the Modbus/TCP servers, each providing multiple simultaneous connections to external clients. This means that it is possible to connect multiple TRiLOGI, ExcelLink and Modbus/TCP clients to the PLC, all at the same time! Section 2.1.5 shows you how you can change the maximum number of connections for each server.

### 2.1.1 IP Address

One of the most important Ethernet parameters that you must define here is the “IP Address” field. By default, every Nano-10 PLC is shipped with the static IP address: “192.168.1.5”. You will need to assign the PLC’s with an IP address that is unique on your network and yet is accessible from your PC. If you are on a company network, then you must consult your company’s system administrator to assign you a useable IP address.

However, if your PC is connected to a small local area network, then most likely you will have a LAN IP address of 192.168.XXX.YYY. For proper networking, you should set the PLC’s IP address to “192.168.XXX.ZZZ”. i.e. The first three numbers should match each other. The fourth number (ZZZ) should be an IP address that is not used by any other devices on your network.

Note that majority of small LANs are built using a network router that assigns dynamic IP addresses (called DHCP server) to the PC. You should enter the administrator page of the router and define the range of DHCP for use by the PCs and then you may assign the PLC with any IP address that is outside of the DHCP range. E.g. If you define the DHCP address range to be 192.168.1.100 to 192.168.1.150, then you may assign the PLC with any IP address between 192.168.1.2 to 192.168.99 (Usually the router itself would have the IP address 192.168.1.1 so that address is not available) and also between 192.168.151 to 192.168.1.254 (again making sure that 192.168.1.254 is not already used by your router).

### 2.1.2 GateWay IP Addr

The Gateway IP address lets the Nano-10 PLC communicate with other LAN segments or connect to the Internet. The gateway address is usually the local IP address of the router where the PLC is connected. For small local networks with no plan for connection to the Internet, the Gateway IP Address is not needed and can be set to 0.0.0.0. But if you plan to use the FServer’s email capability then you must fill in the correct Gateway IP Address. Ask your system administrator if you have any question about this.

### 2.1.3 SMTP Server IP Address

The SMTP (Simple Mail Transport Protocol) Server field lets you define the IP address of the email server that the PLC can use to send out emails from user’s program (please see section 2.4.2 for more details on how to program the PLC to send emails). This is the same SMTP server that your normal email client software such as Thunderbird or MS Outlook uses to send out email. You can ask your Internet Service Provider (ISP) for the IP address of their SMTP server. The ISP usually provides the SMTP server in domain name form (such as “mail.sbcglobal.net”), but you should also be able to request the numerical IP address of the SMTP server from the ISP.

For Windows XP or Vista users, you can resolve the IP address as follows: First, launch the “Command Prompt” window. Then enter the command `nslookup <smtpserver name>` to get the IP address. An example is shown below where the IP address of mail.sbcglobal.net is resolved to the IP address: “207.115.36.120”:

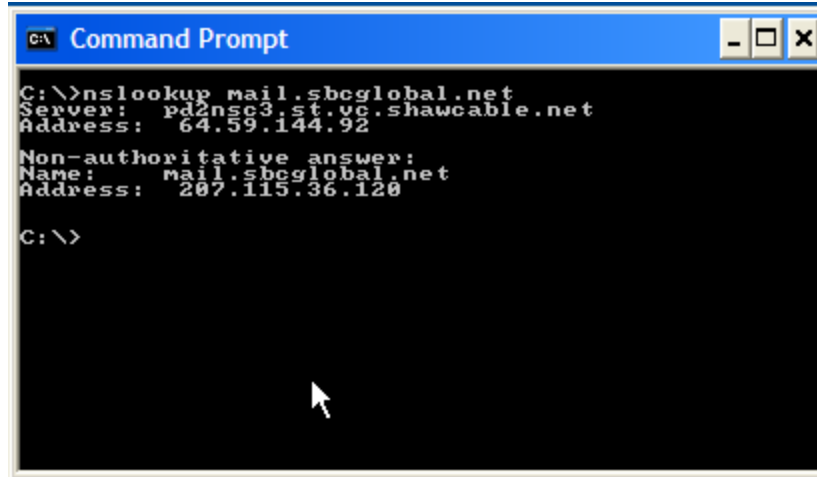

```
C:\>nslookup mail.sbcglobal.net
Server: pd2nsc3.st.vc.shawcable.net
Address: 64.59.144.92

Non-authoritative answer:
Name: mail.sbcglobal.net
Address: 207.115.36.120

C:\>
```

Figure 2.1.3

Windows users may also search the Internet for a free “host.exe” tool that lets you resolve the IP address from a given domain name (one host.exe tool that we found to work was downloaded from <http://pigtail.net/LRP/dig/>). For example, executing the command line: “host mail.sbcglobal.net” will resolve its IP address. (Of course you can only use this smtp server provided your ISP is SBC, almost no SMTP server will relay emails from a client that is not its one of its own subscribers).

If you do not plan to use the FServer to send out emails yet, then you can leave the default SMTP Server IP Address = 0.0.0.0. You can change the settings anytime later when you need it.

#### 2.1.4 DNS Server IP Address

DNS (Domain Name Server) allows the FServer to contact a remote server by means of domain name instead of IP Address. The DNS takes in the given domain name (such as yahoo.com) and returns the IP address of the target server. You will need to fill in the DNS IP Address if you intend to ask the Fserver to resolve a domain name into an IP address, or you intend to contact a client directly by using domain name instead of using IP Address.

**Note:** Only Nano-10 PLC with firmware version r72 and above supports the use of domain name when contacting a remote server.

The DNS server IP address could be the same as the Gateway IP Addr described in section 2.1.3. But it will be more efficient to define the actual DNS server IP address that your ISP provides. You can usually obtain the DNS server IP address by going to the Administrator page of your router and pull up information on the WAN. E.g. The DNS server address you can see from the following screen is 64.59.144.92.

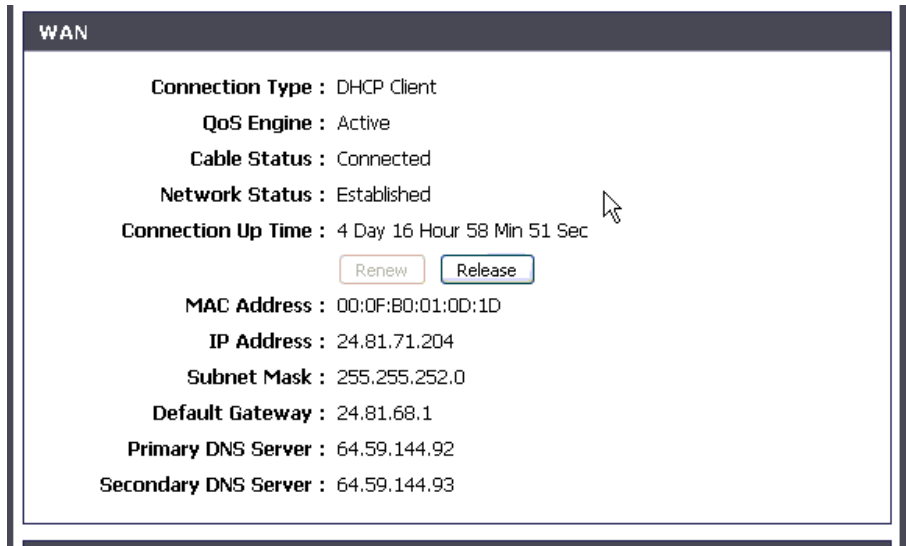

Figure 2.1.4

### 2.1.5 No. of Connections (FServer/ Modbus TCP)

The Nano-10 CPU assigns sufficient memory to support up to a maximum of 6 simultaneous TCP/IP connections to the FServer and Modbus/TCP server. By default, each server is assigned a maximum of 3 connections each. However, to improve flexibility, you can re-assign the mix of maximum connections between the two servers as long as the number of Modbus/TCP connections does not exceed 5 and the number of FServer connections does not exceed 4. This means that you can define 1 to 4 FServer connections and 2 to 5 Modbus/TCP connections. When you change the number in one box the other box will change automatically so that the total number of possible connections remains at 6.

### 2.1.6 FServer Port No.

The Port number is a 16-bit integer (range 0 to 65535) that needs to be specified on top of the IP address when accessing the FServer from across the network. The default value is 9080, which is the same default value used by the TLServer and TRiLOGI client software. Please see the TRiLOGI programmer's manual for an explanation of the use of the port number. One reason why you may want to change the port number is to use the "port forwarding" capability of a NAT router so that different Nano-10 or F-series PLCs may be accessible from the Internet using the same public IP address of the router but with different port numbers.

### 2.1.7 Modbus/TCP Secondary Port No.

According to MODBUS.ORG specifications, all Modbus/TCP servers must listen on port #502. However, Modbus.org also permits the device to be assigned a different secondary port number. As such, the Modbus/TCP server will always listen on port #502 for all of its connections by default. Should you choose to define a secondary port number, then the Modbus/TCP server will only listen on port 502 on one connection while the additional connections (1 to a maximum of 4) would be listening on the secondary port.

You may specify any port number between 1024 and 65535 (except for the port number already used by the FServer) to be the secondary port number. Please see the TRiLOGI programmer's manual for an explanation of the use of the port number. One reason why you may want to change the port number is to use the "port forwarding" capability of a NAT router so that different Nano-10 or F-series PLCs may be

accessible from the Internet using the same public IP address of the router but with different port numbers.

### **2.1.8 LAN Speed**

You can set the LAN speed of the Nano-10 PLC to be either 10 Mbps or 100 Mbps (default) per second using this menu option. Most modern Ethernet switch or router will automatically connect to the PLC using its default LAN speed and there is usually no need for user to configure this option except in very special application where the devices are connected via a 10Mbps Ethernet “hub”, which demands all connected device to be set to the same 10Mbps LAN speed.

### **2.1.9 Node Name**

You can assign up to 16 ASCII characters (any character) in naming a PLC. The node name is currently not used by the network router so it is merely a convenient name for user to identify a PLC.

### **2.1.10 Username and Password (FServer only).**

You can use the username and password feature to prevent unauthorized access to the FServer. It adopts the same proprietary encryption scheme used in the TLServer and TRiLOGI software to encrypt the password transmission. However, unlike the TLServer software that allows you to define unlimited number of usernames and passwords, the FServer only permits a single username and password and this is limited to a length of 16 characters each.

### **2.1.11 Use Username/Password (Yes/No)?**

In applications where there is no danger of unauthorized access to the PLC via FServer, you can elect not to use the username/password. With the “No” option selected, the TRiLOGI client or Java Applet can log-in to the FServer using whatever username and password since FServer will bypass the username and password authentication and allow the client to log in.

### **2.1.12 Access Level**

You can define the access level that the TRiLOGI client is permitted to operate on the PLC. Three access levels are currently defined: 1 for Programmer, 2 for User and 3 for Guest. Choose “1-Programmer” if you wish to be able to program the PLC. Please see the i-TRiLOGI Programmer’s Reference manual for the definition of the access levels.

### **2.1.13 Advanced Configuration**

The Advanced Configuration button lets you configure other more advanced (beyond the basic Ethernet configuration), but less often used features of the PLC. This includes definition of the “Trusted IP” addresses (see [Section 2.4.2](#)) as well as calibrations of the PLCs Analog I/Os and RTC (see [Section 5.4](#)).

### **2.1.14 Standalone Version of Ethernet Configuration Software**

The standalone version of the Ethernet Configuration software, which was previously the only option for configuring the Ethernet port and advanced settings on the F-series PLCs, can also be used to configure the Nano-10 PLC’s Ethernet port. You can download the software from our website at the following URL:

<http://www.tri-plc.com/download/FserverConfig/index.htm>

Please download and run the “SetupFPLCConfig.exe” file from the above URL to install the “F-series Ethernet Configuration Utility” program.

After you have installed the configuration program, please click on the Windows “Start” button and open the “F-series PLC Configuration” group and select the “Ethernet Configuration Utility” program. The following screen should appear:

This configuration program can only communicate with the PLC via its serial port (RS485 in the case of Nano-10). If you PC already has an RS232 port (or USB-RS232 adapter), you can purchase an Auto485 adapter to obtain the required RS485 interface. Otherwise, it may be more convenient to purchase a USB-to-RS485 adapter (e.g <http://www.tri-plc.com/U-485.htm> ) for the program to work with the Nano-10 PLC.

First, click on the “Serial Setup” button and set the PC’s COM port to the same settings as the PLC’s RS485 port. (default settings are 38,400bps, 8 data bit, 1 stop bit and no parity). It is important that you select a valid COM port on the PC, otherwise the program will report an error when it fails to open the COM port. The selected COM port number is shown in a small text box below the “Serial Setup” button so that you can see the currently selected COM port readily.

Figure 2.1.5

Next, click on the “Retrieve Parameters from F-PLC” so that you can capture a copy of the current configuration stored in the Nano-10 PLC. You can then selectively modify the parameters of interest.

The main difference between this standalone version of the F-series Ethernet Configuration software and the built-in version on i-TRiLOGI 6.3x is that the stand-alone version can only communicate directly with the PLC via the serial port, and it does not require the i-TRiLOGI or TLServer software. The built-in version in i-TRiLOGI, on the other hand, can communicate with the PLC through either locally via the serial port or remotely via the Ethernet connection.

The standalone version can be useful for OEMs who want to provide their customers a way to configure the Ethernet settings, and/or calibrate the ADC, and RTC settings but don’t want to provide access to the programming software. However, the OEMs must remember that their customers’ PC would require the RS485 interface converter to use this standalone software with the Nano-10 PLC.

**Important:** If you make changes to any of these fields, you must select the “Reboot PLC After Save” checkbox before clicking the “Save Parameters to PLC button” so that the new parameters will be saved to the flash memory of the PLC and the new parameter can take effect immediately.



## 2.2 Connecting Ethernet to the PLC

### Introduction

All FMD PLCs can connect to the PC running TRiLOGI many ways as follows:

- a) Wired connection to a router that the PC is also connected to (PC connection can be wired or wireless).
- b) Direct connection to the PCs wired Ethernet port via crossover cable
- c) Wireless connection to a wireless router if the PLC is connected to a wireless bridge (adapter)

Only the first two options, which are most common, will be described here.

### 2.2.1 Connecting the PLC to a Local Area Network

In a typical local area network (LAN) there would be one router (wired or both wired and wireless) that the network devices connect to, one modem that provides Internet to the router, and the devices connected to the router (such as the PLC and PC).

#### Before You Begin

The first thing you need to do is configure the network settings in the PLC to match those of the LAN. This is typically done as follows:

- 1) Find out what your routers gateway address is (typically 192.168.1.1 or 192.168.0.1) and what static IP addresses are free to use with your PLC.

*NOTE: if the routers gateway address is "192.168.1.1", the default PLC IP address (192.168.1.5) will most likely work unless it is already used by another device on the same network. If it is free to use, the next two steps can be skipped as the PLC will already be able to connect to the LAN.*

- 2) Connect to the PLCs serial port from the PC with TRiLOGI and TLServer.
- 3) Edit the PLC network settings using the Ethernet & ADC Configuration tool from the "Controller" menu in TRiLOGI. Only the IP address is necessary to configure for basic connection to the LAN.

Please refer to the Quick Connection guide in appendix 1 of the [i-TRiLOGI Programmers Reference Manual](#). to connect the PLC to your PC via serial port.

Please refer to [section 2.1](#) of this manual for more detailed information on network configuration.

#### Network Wiring

You will likely already have a network available that consists of an Internet modem that provides Internet to a wired or wireless router, which has at least one PC connected to it.

In this case, all that needs to be done is connect the PLC to the router with standard Ethernet cable. The final network configuration will likely resemble the below simple network diagram.



If you are on a corporate network, then you will need to consult the IT administrator to get the PLC connected to the network.

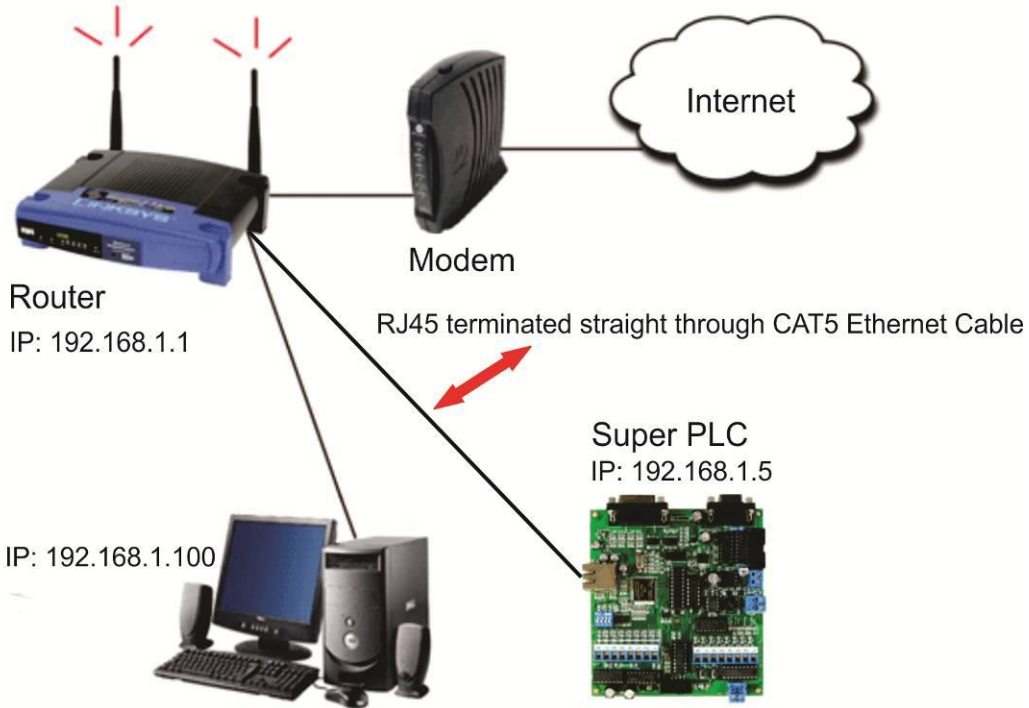

## 2.2.2 Setting up Ethernet Communication Directly Between a PC and an FMD PLC

It is possible for your PC to communicate directly with an NANO-10 PLC through the Ethernet port. This means that you can have a peer-to-peer connection between the NANO-10 PLC and your PC without an Internet connection or any additional network equipment. The PC being used would need a spare Ethernet port in order to do this.

### What You Will Need

1. A PC with a spare Ethernet port (RJ45 connection)
2. An Ethernet cable\*\*
3. A NANO-10 PLC

\*\*There are two types of Ethernet cables: A standard straight through cable, which is used in most situations, and a crossover cable, which is required when there is no auto-switching hardware in either of the two Ethernet ports (PC and PLC). The NANO-10 PLC does NOT have auto-switching capabilities so it will depend on the PC's Ethernet port whether or not a crossover cable is required. If you are not sure if your PC's Ethernet port is able to perform auto-switching (most modern PC has auto-switching built-in), then it is best to use a crossover cable. A crossover Ethernet cable will work in both situations, but a straight through Ethernet cable will only work if one or both of the Ethernet ports can perform auto-switching.

### How to Set Up Your PC

Before you can communicate with the PLC, you will need to configure the Ethernet port on your PC to match the settings that you configured in the PLC (default IP is 192.168.1.5). For more information on configuring the PLC Ethernet settings, see section [2.1 Configuring The Ethernet Port](#). Once you have configured your PLC's Ethernet settings (If you decided to change the default IP), you will need to set your PC's Ethernet port to have a static IP address that is on the same subnet as the IP address that is set for your PLC. How you do this is a bit different depending on your operating system, so the following sections will show step-by-step instructions for configuring your PC's Ethernet settings on Windows XP, Windows 7, and Windows 8.

### Windows XP Ethernet Configuration

1. **Open Network Connections.** The first thing you will need to do is open the Network Connections window from the "Start" menu by selecting "Show all connections" from the "Connect To" menu, as shown here:

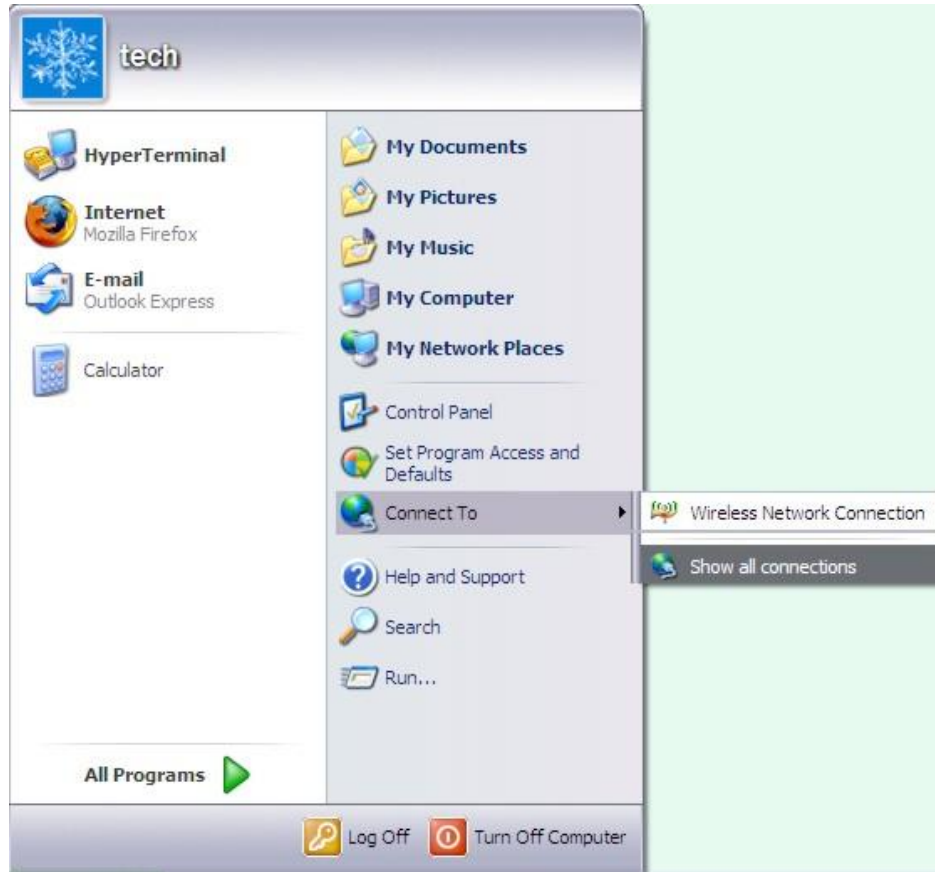

Figure 2.8.1

2. **Local Area Network Properties.** Next the Network Connections window should open, which will display all of your network connections.



Figure 2.8.2

Now you can either right click on the Local Area Connection and select “Properties” or highlight it and click on “Change settings of this connection” from the Network Tasks sidebar, as shown above. When you do this, the following window will open.

### 3. Edit TCP/IP Properties

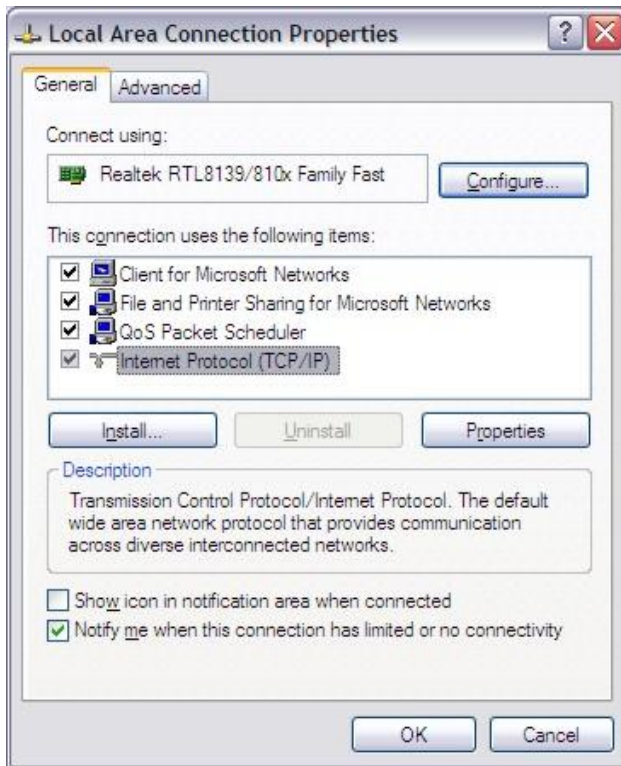

Figure 2.8.3

Now you want to highlight the Internet Protocol (TCP/IP) item and click on Properties. This will open up a new window that allows you to change the network settings for the Ethernet port that you selected. The Ethernet hardware you are configuring is shown under “Connect using:” in the current window.

### 4. Configure IP Address and Gateway

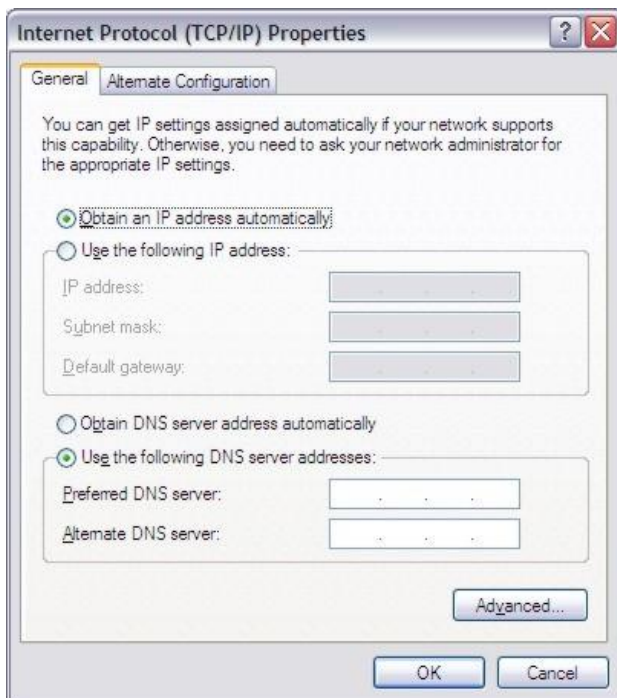

Figure 2.8.4

By default your Ethernet settings will be configured to be obtained automatically (in this case only the IP settings are set to be obtained automatically). This setting will not work since the NANO-10 PLC does not have the ability to assign IP address to the PC’s Ethernet port. So you need to manually set the IP address and the Subnet mask. The IP address should be on the same subnet as the IP address you have set for your PLC. For example, if your PLCs IP address is set to the default address of “192.168.1.5”, then you should set your PC’s IP address to be:

192.168.1.xxx

The xxx can be any number between 1 and 255, except for 5 (your PC can’t have same IP address as your PLC)

The Subnet mask should be set to “255.255.255.0” no matter what and the other settings should be left blank because you won’t be connecting this Ethernet port to the Internet.

## 5. Sample Configuration

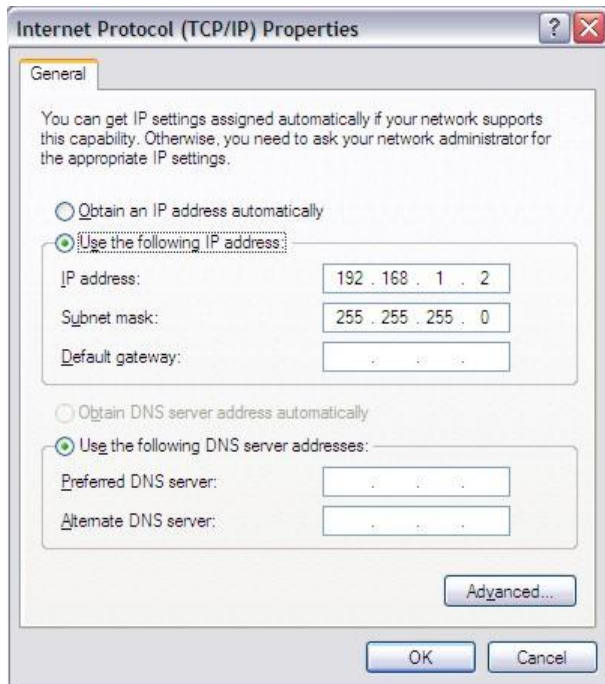

Here is an example of a configuration that will work if your PLC has an IP address of 192.168.1.xxx, where xxx is anything from 1-255 except 2.

Once you have set the IP address and Subnet mask, you can click on OK and then click on OK again to close the “Local Area Connection Properties” window shown in Figure 2.8.5

Figure 2.8.5

Now your Ethernet port has been configured and you can try to connect to your PLC from TRILOGI using your PLCs IP address and port number.

### Note:

1. Connecting the PC's Ethernet port directly to the PLC only establishes a private network connection between the two devices. That is to say, the PLC connected this way is ONLY accessible to this PC. Even if the PC is connected to a LAN (e.g. via Wi-Fi connection), the PLC connected to this PC via direct Ethernet connection will not be accessible by any other devices on the same LAN. and the PLC will not be able to open network connection to any other devices beyond the PC that it is connect to this way.
2. Sometimes the PC that is connected directly to the PLC via Direct Ethernet Connection may lose its Internet connection via Wi-Fi. This is because the O/S thinks that the direct Ethernet connection to the PLC is a real network connection and attempt to route TCP/IP packets through it. That will result in a connection failure. If this occurs and you need to access the Internet, then please temporarily remove the Ethernet cable from the PLC and the PC should then be able to access the Internet again.

### Windows 7 Ethernet Configuration

1. **Open the Network Window.** The first thing you will need to do is open the Network window from the “Start” menu by selecting “Network”, as shown here:

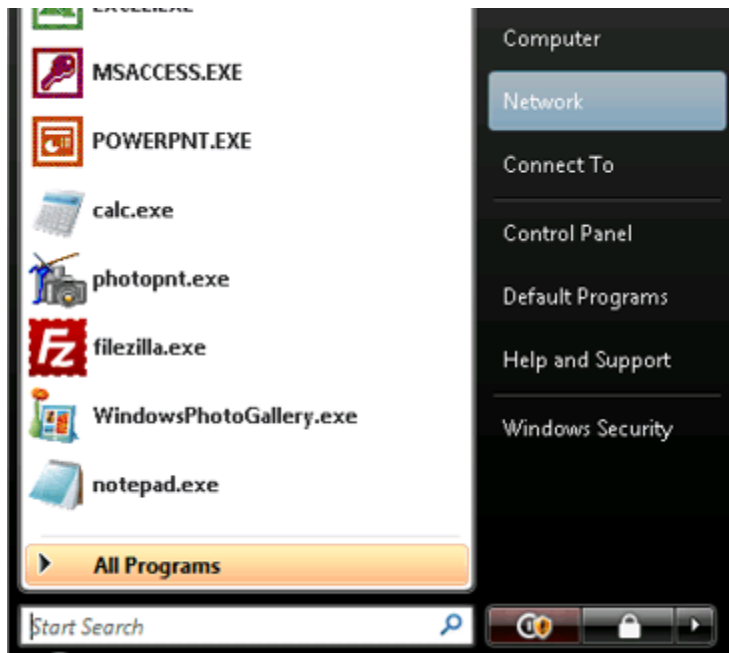

2. **Open Network and Sharing Center:** In the Network window, click on the Network and Sharing Center option on the top pane as in the below picture.

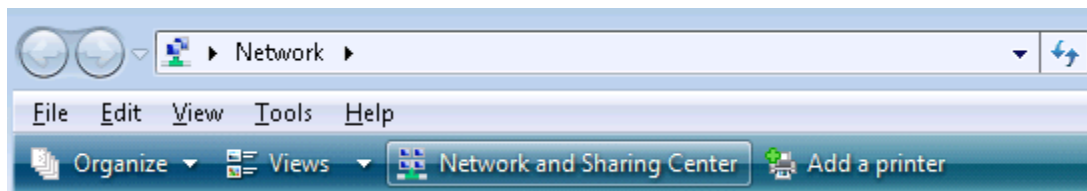

3. **Manage Network Connections:** In the Network and Sharing Center window, click on the Manage network connections option under the tasks pane on the left side of the window as in the below picture.

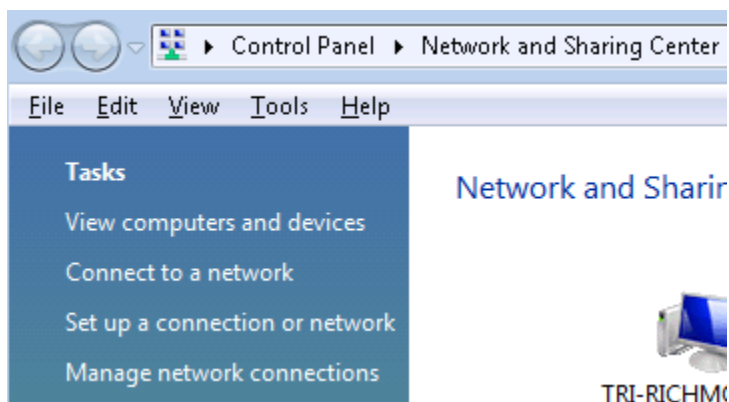

4. Follow steps 2-5 in the [Windows XP Ethernet Configuration](#) section above to complete the setup, as it is the same process.

### Windows 8 Ethernet Configuration

1. **Open the Network Window.** The first thing you will need to do is open the Control Panel from the "Start" menu by right-clicking in the bottom left corner of the screen where the Start Menu is accessed (below left screenshot):

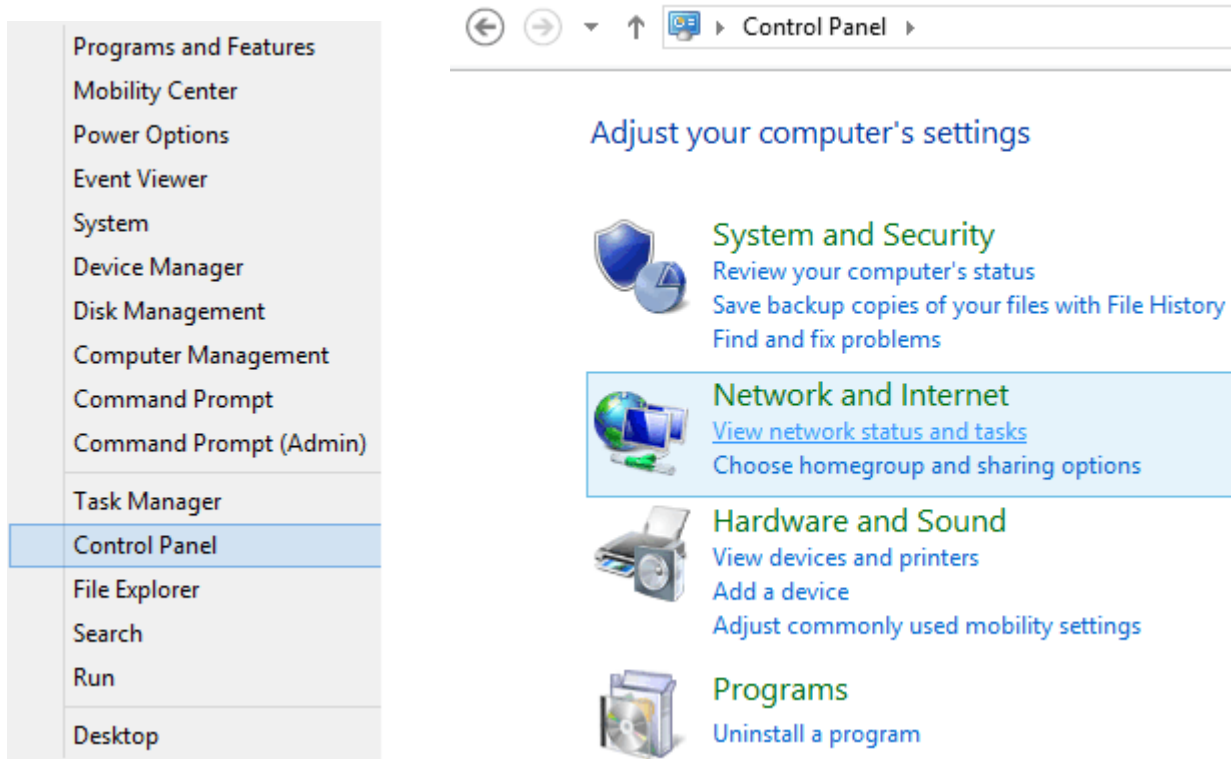

2. **Open View Network Status and Tasks Window.** Next you need to click on the "View network status and tasks" link under the "Network and Internet" category (above-right screenshot), which will bring up the "Network and Sharing Center" window (below screenshot).

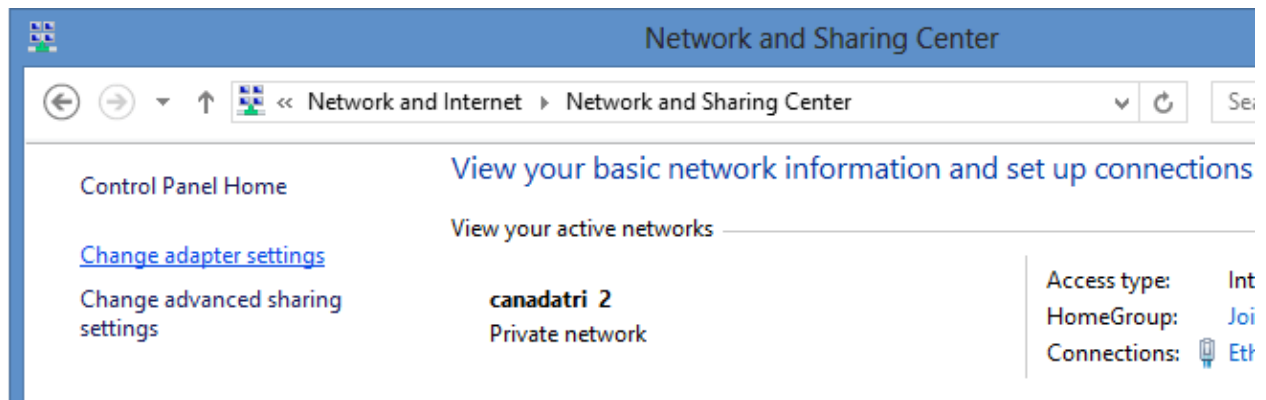

3. **Click on the "Change Adapter Settings" Link.** This will bring up the "Network Connections" window where you can configure the necessary network settings for the local adapter.

Follow steps 2-5 in the [Windows XP Ethernet Configuration](#) section above to complete the setup, as it is the same process.



## 2.3 On-line Monitoring/Programming via FServer

If you have used the i-TRiLOGI software to connect to TLServer or the X-Server previously, the procedure is identical. To test i-TRiLOGI communication with the Nano-10 PLC, click on “Controller -> On-Line Monitoring”, or simply press <CTRL-M> keys.

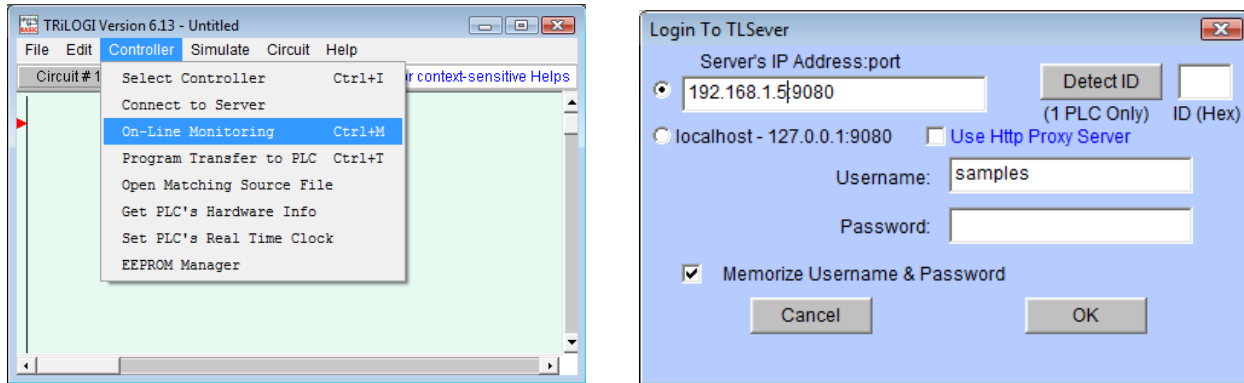

Figure 2.2.1

When the “Login To TLServer” screen pops up, enter the “IP address : port”, the username and the password that you have defined for the FServer earlier using the configuration tool, and click on the “Detect ID” button to detect the PLC’s ID. If i-TRiLOGI is able to connect to the Nano-10 PLC via the Ethernet network, then the PLC’s ID will appear in the ID box. When you click the “OK” button, the on-line monitoring screen should appear and you should see the “Activity LEDs” on the RJ45 connector blinking away. You have now successfully connected to the FServer and you can run all the commands under the “Controller” menu, including transferring your new program to the PLC or setting the PLC’s Real Time Clock, etc. For more details on using these commands, please refer to i-TRiLOGI Programmer’s Reference.

Likewise, to transfer your new program to the PLC, you can click on the “Controller” menu and select “Program Transfer to PLC” or press the <Ctrl-T> keys. If i-TRiLOGI is already connected to the FServer, the program transfer will begin immediately after you’ve confirmed your action. Otherwise the same “Login to TLServer” screen, as shown on Figure 2.2.1, will appear for you to complete the login sequence.

### Note:

- 1) Unlike the TLServer software that runs on the PC, which allows unlimited connection time, the FServer on the Nano-10 PLC will disconnect the client if there is no activity for more than 10 minutes. The older version of the i-TRiLOGI program may not detect that the connection has been closed and it may instead think that the PLC is not present. When this happens you should click on “Controller” menu and select “Disconnect” to properly shut down the connection that has already been reset by the PLC.
- 2) If you are unable to connect to the PLC, then check that both the PLC and the PC running your i-TRiLOGI software are connected to the same local area network (LAN) and are on the same subnet. Generally for a subnet mask of 255.255.255.0, if the PC’s IP address is 192.168.1.xxx then the PLC should have an IP address of 192.168.1.yyy and it will not work if the PLC has IP address such as 192.168.0.yyy or 192.168.2.yyy, since this means that the two devices are on different subnets. Likewise, if your PC’s IP address is “192.168.0.xxx”, then please change your PLC’s IP address to “192.168.0.yyy”. Also ensure that the PLC’s IP address is not already assigned to another device on the same network, otherwise a conflict would occur and communication is not possible.

## 2.4 Using Fserver “Network Services” Commands

The F-Server firmware in the Nano-10 PLC implements a list of “Network Services” commands similar to what you may have read in the User’s Manual of the X-Server (“NS commands) and TLServer (“Files and Email Services”).

These “Network Services” or **NS** in short, can be used to instruct the Nano-10 PLC’s operating system to perform a number of network related client connection via the Ethernet port. These commands allow the PLC to connect remotely to another PLC in another building or another part of the world via the Internet! This allows peer-to-peer networking, or so-called “M2M” (machine to machine communication) to take place between the PLCs.

### Notes:

1. In the case of the X-Server and TLServer, the PLC typically communicates with these external hardware or software servers via its COMM1 serial port, and thus TBASIC statements and functions such as PRINT #1, INPUT\$(1) and NETCMD\$(1) are used since the NS commands are sent through the serial port #1.
2. Since the Ethernet is already built-in on the Nano-10 PLCs, you do not need to send NS commands via any of its serial port (this also means that no serial port is sacrificed in order to have access to Ethernet communication). However, to help users of the XServer and TLServer migrate easily to the Nano-10 PLC Ethernet port, we implement the NS commands using similar command format as that on the XServer and TLServer. But instead of sending the commands through COMM1, you will interact with the O/S through COMM port #4.  
d  
Of course, since the Nano-10 PLC doesn’t have 4 serial ports, COMM port #4 is therefore only a “virtual comm. port” and its creation is merely to simplify implementation of the NS commands.
3. The “[TestEthernet.pc6](http://www.tri-plc.com/trilogi/Nano10Samples.zip)” (download from: <http://www.tri-plc.com/trilogi/Nano10Samples.zip>) includes all examples of how to use the NS commands via virtual comm. port #4, which serves as a good starting point for you to learn these simple but yet powerful methods for making a client connection over the LAN or the Internet.
4. The PLC reserves only a single client socket to implement the Network Services. If you use any of the NS commands listed below, please ensure that the command is completed (so that the client socket can be closed) before issuing a different NS command.

All NS commands begin with a string enclosed within the angle bracket called a “tag”, e.g. “<EMAIL>”, “<CONNECT>”. Most NS commands end with a closing tag “</>” except the “<REMOTEFSS>” tag, which ends with a “</REMOTEFSS>” closing tag. Depending on the command type, the Nano-10 CPU may return one or more response strings via virtual comm. port #4, from which the PLC can read to determine if the NS command has been executed properly.

The PLC can operate the Ethernet port by means of TBASIC INPUT\$ and PRINT # commands operating on COMM 4. It uses the PRINT #4 command to send out NS commands and the INPUT\$(4) command to receive response data via the Ethernet port.

### Notes:

1. UNLIKE the case of T100MD PLC + XServer, the CPU does not route communication data that the FServer (or Modbus/TCP server) is exchanging with external clients to the virtual comm port #4. This means that there would not be interference to the NS command/response being sent and received by the PLC program via virtual comm. port #4. As such, there is no need to implement the "arbitration" method mentioned in the XServer User's Manual for this PLC.
2. Only PRINT #4 and INPUT\$(4) are implemented on virtual COMM port #4. Nano-10 PLC DOES NOT support the INCOMM (4) and OUTCOMM 4 commands. However, you may send any non -zero ASCII data using the PRINT #4 command.

The following subsections describe the various Network Service commands available to the Nano-10 PLC.

### 2.4.1 Get Our Local IP Address

**Format:** <IP>

**Response:** xxx.xxx.xxx.xxx:nnnn (IP address:port of FServer)

**Example:** PRINT #4 "<IP>"  
SETLCD 1,1,"Our IP="+INPUT\$(4)

**Note:** This IP address is returned instantly, so there is no need to wait for INPUT\$(4). There is also no need for the closing tag </>

### 2.4.2 DNS command: Resolving Domain Name into IP Address

In order to use this command successfully, you must first correctly define the DNS Server IP address mentioned in [Section 2.1.4](#).

**Format:** <DNS [domain name]>

**Response:**

xxx.xxx.xxx.xxx	IP address string returned by DNS server
ERR:07-DNS Unresolved	Either DNS server not properly defined or the domain name does not exist.

**Response:** xxx.xxx.xxx.xxx (IP address string returned by domain name server)

**STATUS(3):** This function returns 1 on success and 0 on failure.

**Example:**

```
PRINT #4 "<DNS tri-plc.com>"
FOR I = 1 to 10000
  A$ = INPUT$(4)
  IF LEN(A$) <> 0
    SETLCD 1,1," IP="+A$
  RETURN
ENDIF
NEXT
```

**Notes:**

- a) There is no need for the closing tag `</>` to end this command.
- b) If your DNS server has been correctly defined, the above program should return the IP address as a string such as "130.94.216.144". You can then use this IP address string in all the other NS commands to be described in the following sub-sections.
- c) The DNS server may take some time to resolve the domain name. If it is unable to resolve the domain name then it will return an error string, so your program should test to see if it receives the ERR07 error message to determine whether the returned string is useable.
- d) Although it is possible to embed the domain name directly in the NS command in place of IP address, it is usually much more efficient to use the IP address directly if it is known in advance. This is because the DNS server may take some time to resolve the domain name into IP address each time it is called, and there is a possibility that the domain name server may be overloaded or down momentarily when it is needed, and hence complicating the attempt for the PLC to connect to a remote server. Therefore we recommend that you use the `<DNS domain >` tag to resolve the domain name into IP address first and then use the resulting IP address for all Network Services commands via the Internet.

### 2.4.3 Send Email

**Format:**       `<EMAIL [recipient email address]>`  
                               `SENDER: [sender email address]`  
                               `SUBJECT: [whatever text string]`  
                               `[body of the email line 1]`  
                               `[body of the email line 2]`  
                               `....`  
                               `</>`

**Response:**

<code>&lt;OK&gt;</code>	Email successfully sent
<code>ERR:04-Not Connected</code>	Failed to connect to SMTP server (Section 2.1.3)
<code>ERR:06-Email Failure</code>	Failed to complete email transmission.

**STATUS(3):** This function returns 1 on success and 0 on failure. Note that this function only returns the email status after the closing tag `</>` has been sent. If the function is polled before the last closing tag is sent, the status is indeterminate.

**Description:** You can use this command to send out an email for you at any time. The FServer uses the SMTP server and Gateway IP addresses defined by the Nano-10 (See [Section 2.1](#)) to perform this task. If it encounters any errors, it will send back an error string, which begins with the "ERR:" followed by the reason for the error. Although the sender's email address does not have to be a valid email address, it is good to at least use a valid domain name as the sender address. Otherwise the SMTP server may refuse to send the email because it may deduce that an email with an invalid domain name is likely to be a Spam mail.

**Example:** Please refer to the fnEmail function in the "TestEthernet.PC6" file.

## 2.4.4 Open Connection to Remote FServer or TServer to Use NETCMD\$

**Format:** <CONNECT [IP address:port of TServer or XServer]>  
[username string]  
[password string]

**Response:**

<CONNECTED>	Successfully connected to remote FServer, TServer or XServer at the IP address.
ERR:05-Prev Conn.ON	Another NS command has been executed and left the client socket opened but did not execute the PRINT #4 "</>" to close the client socket.
ERR:04-Not Connected	Failed to connect to remote Fserver or TServer.

**STATUS(3):** This TBASIC function returns 1 if the connection is active and returns 0 if the connection has ended. You can test the connection status to determine if the connection is still alive.

**Description:** This service allows your PLC to log in to another Nano-10, an F-Series PLC or a T100MD+ PLC connected via TServer or XServer through the Internet.

You execute this command by first sending the string "<CONNECT xxx.xxx.xxx.xxx:9080>" using the PRINT #4 command, where xxx.xxx.xxx.xxx is the IP address of the remote FServer or TServer, followed by sending the username and password needed to log in to the remote server. Each line should be terminated with a CR (carriage return) character. (The PRINT #4 command automatically appends the CR character).

Once a connection with the remote server is established, the CPU will return the response string <CONNECTED> to the user program, which can read it using the INPUT\$(4) function. The STATUS(3) function can also be used to test if the connection is successful and alive. When the program gets the confirmation of connection, it can then use the TBASIC "NETCMD\$(4, x\$)" command to read or write data to the remote PLCs as if the remote PLC is locally connected to COMM4 port of this PLC, as shown in the following example:

```
A$ = NETCMD$(4, "@01RI00")
```

Multiple NETCMD\$ commands can be executed as long as the connection is alive. You can test the connection status by checking the result of the STATUS(3) function.

Once all the command exchanges have been completed, you should send a </> tag to close the client connection to the remote server so that other NS commands can be executed in other parts of the program.

**Example:** Please refer to the "fnConnect" and "fnNetCmd" custom functions in the demo program: "TestEthernet.PC6".

## 2.4.5 Remote File Services

**Format:**     <REMOTEFMS [IP Address of remote TLServer 2.1 & above]>  
                   [File Service tag for TLServer]  
    \* \* \* \* \*  
                   </REMOTEFMS>

**Response:**    The response strings sent by the remote TLServer in response to the [File Service tag] sent by this PLC. Or,

ERR:04-Not Connected	Failed to connect to remote TLServer.
----------------------	---------------------------------------

**Example:**     Please refer to the “fnRFS1” and “fnRFS2” custom functions in the demo program: “TestEthernet.PC6”.

**Description:**     This commands allows the Nano-10 PLC to connect to a remote TLServer to perform any of the “Files & Email Services” that a TLServer normally provides to PLCs that are connected to it. This includes creating text files on a remote PC running the TLServer software and writing or appending data to it anytime. This makes it very convenient for the PLC to collect large amounts of data and save them to the easily accessible, virtually limitless hard disk storage space that is available in today’s PCs.

For detailed descriptions of the available [File Service Tags] please refer to TRILOGI programmer’s reference manual under the chapter “File & Email Services”.

All TLServer’s “File & Email Services” tags, such as <Email>, <WRITE>,<APPEND>, <READ> and <READ RTC> are available to the Nano-10 PLCs through the use of the **<REMOTEFMS** tag. You simply have to wrap the abovementioned command tags between the **<REMOTEFMS IPAddr:port>** and **</REMOTEFMS>** tag, where “IPAddr:port” is the IP address and listening port of the remote TLServer. E.g. through the <READ RTC[ ]> tag, the PLC can synchronize its Real Time clock with a remote TLServer. (As you will later see, this feature is probably not very useful for the Nano-10 PLC anymore since Nano-10 has the ability to connect to the NIST Time Server to update its real time clock to Atomic clock accurately!)

**Note:** Only TLServer version 2.1 or above can handle the <REMOTEFMS> command tag sent by the Nano-10 or F-series PLC.

**2.4.6 Other Network Services Tags**

We will describe two more Network Services commands:    <TCPCONNECT> and <MBTCPCONNECT> in separate sections later in this manual.

## 2.5 MODBUS/TCP Server and Client Connection

The Nano-10 PLC supports both the FServer and the industry standard **MODBUS/TCP** server simultaneously. This means that all Nano-10 PLCs are ready to interface directly with many third party industrial control devices that support the MODBUS/TCP protocol. These include the SCADA software, HMI hardware, OPC Server, HVAC controllers and many other industrial control devices.

In addition, the Nano-10 PLC can be used both as a MODBUS/TCP **SERVER** as well as a MODBUS/TCP **CLIENT** simultaneously. This means that the Nano-10 PLC can readily read data from any device that has a MODBUS/TCP server, such as: flow meters, AC/DC drives, HVAC elements, RTUs, network sensors etc. It is also possible to perform **peer-to-peer** networking with other MODBUS/TCP controllers (e.g. another Nano-10 or F-Series PLC) over a LAN or over the Internet!

### 2.5.1 Connecting To The PLC's MODBUS/TCP Server

By default, the Nano-10 CPU supports up to 3 simultaneous MODBUS/TCP connections. You can change the number of simultaneous MODBUS/TCP connections from 2 to 5 using the "Ethernet Basic Configuration Tool" program as described in Section 2.1.

The PLC will listen on the default, well-known MODBUS/TCP port #502 for one or all of the connections. However, it is also possible to define a secondary port number using the Nano-10 Ethernet Configuration program as described in [Section 2.1.7](#) (Note that if you define a secondary port number, then only one of the MODBUS/TCP connection will listen on port #502 and the remaining connections will only be listening on the secondary port number.)

If you have a MODBUS/TCP client program (e.g. you can download a trial version of "Modbus Poll" from <http://www.modbustools.com> for testing), you simply specify the Nano-10 IP address and connect to it. Once connected, you will then be able to read from or write to most of the Nano-10 PLC's internal data from the MODBUS/TCP client. The PLC's I/O and internal variables are mapped to the MODBUS device space according to Table 2.1.

#### 2.5.1.1 *Bit Address Mapping*

All the Nano-10 PLC I/O bits are mapped identically to both the MODBUS "0x" and 1x space. The bit register offset is shown in the last column of Table 2.1. Although MODBUS names the "0x" address space as "Coil" (which means output bits) and the "1x" address space as "Input Status" (which means input bits only), the Nano-10 PLC treats both spaces the same. Some MODBUS drivers only allow a "read" from 0x space and a "write" to 1x space but you still use the same offset shown on Table 2.1.

Example:

1. To map an element to the PLC Input 4, you select the MODBUS register address 0-0004. You can also map the element to the PLC's output #2. In that case, you should map it to MODBUS register address 0-0258.
2. To map an HMI toggle switch symbol to the PLCs input #4, if you are restricted to select only MODBUS 1x address space, then you will have to map the switch to 1-0004, and, likewise, you can map the switch to output #2 using the MODBUS address 1-0258. However, if the driver allows the switch to be mapped to the 0x space then you can use MODBUS register space 1-0258 and 0-0258 for the output #2 mapping with identical result.

Table 2.1 Memory Mapping of Nano-10 CPU Internal Data to MODBUS Register

NANO I/O #		MODBUS Word Addr. Mapping	MODBUS Bit Addr. Mapping
Input	<b>n</b>		<b>n</b>
	1 to 16	40001.1 to 40001.16	1 to 16
	17 to 32	40002.1 to 40002.16	17 to 32
	33 to 48	40003.1 to 40003.16	33 to 48
	49 to 64	40004.1 to 40004.16	49 to 64
	65 to 80	40005.1 to 40005.16	65 to 80
	81 to 96	40006.1 to 40006.16	81 to 96
Output	<b>n</b>		<b>256 + n</b>
	1 to 16	40017.1 to 40017.16	257 to 272
	17 to 32	40018.1 to 40018.16	273 to 288
	33 to 48	40019.1 to 40019.16	289 to 304
	49 to 64	40020.1 to 40020.16	305 to 320
	65 to 80	40021.1 to 40021.16	321 to 336
	81 to 96	40022.1 to 40022.16	337 to 352
Timer	<b>n</b>		<b>512+n</b>
	1 to 16	40033.1 to 40033.16	513 to 528
	17 to 32	40034.1 to 40034.16	529 to 544
	33 to 48	40035.1 to 40035.16	545 to 560
Counter	<b>n</b>		<b>768 + n</b>
	1 to 16	40049.1 to 40049.16	769 to 784
	17 to 32	40050.1 to 40050.16	785 to 800
	33 to 48	40051.1 to 40051.16	801 to 816
Relay	<b>n</b>		<b>1024 + n</b>
	1 to 16	40065.1 to 40065.16	1025 to 1040
	17 to 32	40066.1 to 40066.16	1041 to 1056
	33 to 48	40067.1 to 40067.16	1057 to 1072
	49 to 64	40068.1 to 40068.16	1073 to 1088
	65 to 80	40069.1 to 40069.16	1089 to 1104
	81 to 96	40070.1 to 40070.16	1105 to 1120
	97 to 112	40071.1 to 40071.16	1121 to 1136
	113 to 128	40072.1 to 40072.16	1137 to 1152
	129 to 144	40073.1 to 40073.16	1153 to 1168
	145 to 160	40074.1 to 40074.16	1169 to 1184
	161 to 176	40075.1 to 40075.16	1185 to 1200
	177 to 192	40076.1 to 40076.16	1201 to 1216
	193 to 208	40077.1 to 40077.16	1217 to 1232
	209 to 224	40078.1 to 40078.16	1233 to 1248
..	..	..	
497 to 512	40097.1 to 40097.16	1521 to 1536	



Nano-10 PLC's	Variables	MODBUS
Timer Present Values	1 to 64	40129 to 40192
Counter Present Values	1 to 64	40257 to 40320
Clock	TIME[1] TIME[2] TIME[3]	40513 40514 40515
Date	DATE[1] DATE[2] DATE[3] DATE[4]	40517 40518 40519 40520
Data Memory	DM[1] DM[2] .... DM[4000]	41001 41002 .... 45000

### 2.5.1.2 Word Address Mapping

As shown in Table 2.1, to access the PLC's DM[1], you use MODBUS address space 4-1001 and so on. To access the Real Time Clock Hour data (TIME[1]), use 4-0513. The I/O channels can also be read or written as 16-bit words by using the addresses from 4-0001 to 4-0320.

Some MODBUS drivers (such as National Instruments "Lookout" software) even allow you to manipulate individual bits within a 16-bit word. So it is also possible to map individual I/O bits to the "4x" address space. E.g. Input bit #1 can be mapped to 4-0001.1 and output bit #2 is mapped to 4-0257.2, etc. This is how it is shown in Table 2.1. However, if you do not need to manipulate the individual bit, then you simply use the address 4-0001 to access the system variable INPUT[1] and address 4-0257 to access the system variable OUTPUT[1]. Note that INPUT[1] and OUTPUT[1] are TBASIC system variables and they each contain 16 bits that reflect the on/off status of the actual physical input and output bits #1 to #16.

## 2.5.2 MODBUS/TCP Access Security

If a Nano-10 PLC is to be accessible only on the local area network, then the direct connections offered by MODBUS/TCP provide simplicity without time-consuming login sequences. However, if the MODBUS/TCP port is to be exposed to the public Internet, then you ought to consider the security issues associated with MODBUS/TCP connections.

Since a MODBUS/TCP connection does not require a username/password login sequence (unlike the FServer login), the only way to protect against unauthorized access is through the "Trusted IP" addresses defined using the Ethernet Configuration software.

You can use either the Ethernet Configuration Tool mentioned in [Section 2.1](#), or the standalone F-series Ethernet Configuration program mentioned in [Section 2.1.14](#) to define a list of “Trusted IP” addresses. Please click on the “Advanced” button on the “Basic Configuration screen” (as shown in Figure 2.4.1) and you should see the following Advanced Configuration screen.

Figure 2.4.1

The first thing you should do is to click on the “Retrieve Parameters from PLC” so that you can capture a copy of the current configuration in the PLC and you can then modify selectively.

You can define a list of up to 6 “Trusted IP” addresses in this panel. To enable the Modbus/TCP Trusted IP, click on the “Yes” button next to the “Modbus/TCP Use Trusted IP”.

**Note:** The FServer can also be enabled to only allow connections from devices that match one of the “Trusted IP” defined in this panel. This is on top of the username/password login sequence that can be enabled/disabled from the Basic Configuration screen. In other words, you can choose either security method to access the FServer or implement both security methods at the same time.

After you have defined the list of trusted IP addresses and checked the “Use Trusted IP” radio button, click on the “Save Parameters to PLC” to save your data to the PLC’s non-volatile memory.

When “MODBUS/TCP Use Trusted IP” is enabled, it means that only TCP/IP packets that come from a client whose IP address matches one of the “Trusted IP” would be allowed connection to the MODBUS/TCP server.

### 2.5.3 Making A Modbus/TCP Client Connection to Other Modbus/TCP Server

By using the “Network Services” commands described in Section 2.4, it is unbelievably easy for the Nano-10 PLC to be used as a MODBUS/TCP client to access any industrial control or HVAC device and sensors that support a MODBUS/TCP server. Best of all, you can do it without learning any specifics of TCP/IP programming!

To open a client socket and connect to a Modbus/TCP Server that is listening on port 502 (default Modbus/TCP port), you only need to send the command tags <MBTCPCONNECT xxx.xxx.xxx.xxx:502> to the CPU via virtual COMM port #4. E.g.

```
PRINT #4 "<MBTCPCONNECT 192.168.1.105:502>"
```

If connection is successful, the system will return the string “<CONNECTED>” on virtual comm. port #4, which you can check with the INPUT\$(4) command.

Once the connection is successfully established, you can begin to use the built-in TBASIC commands: READMODBUS, WRITEMODBUS, READMB2 and WRITEMB2 operating on virtual comm. port #4 to send MODBUS commands and receive processed responses from a remote MODBUS/TCP Server!! This greatly simplifies your programming task, since it is very similar to communicating with a Modbus RTU slave that is connected to the serial port #1, 2, or 3. Although in this case, the Modbus/TCP device could be located in the other hemisphere and connected via the Internet!

The full syntax for the <MBTCPCONNECT> tag is described below:

**Format:** <MBTCPCONNECT [IP address:502] of another Modbus/TCP Server>

**Response:**

<CONNECTED>	Successfully connected to the Modbus/TCP server of the specified IP address.
ERR:05-Prev Conn.ON	Another NS command has been executed and left the client socket opened but did not execute the PRINT #4 "</>" to close the client socket.
ERR:04-Not Connected	Failed to connect to the targeted Modbus/TCP Server

**STATUS(3):** This TBASIC function returns 1 if the Modbus/TCP connection is live and returns 0 if the connection has ended. You can test the connection status to determine if the connection is still alive.

**Description:** This service allows your PLC to log in to any device that supports a Modbus/TCP server and is connected to the same LAN or to the Internet. Of course, you may also use it to connect to another Nano-10 or F-Series PLC on the Internet since every these PLCs all have MODBUS/TCP server too.

Once the connection with the Modbus/TCP server is established, the CPU will return the response string **<CONNECTED>** to the users program, which can read it using the INPUT\$(4) function. The STATUS(3) function can also be used to determine if the connection is successful and alive.

When the program gets the confirmed connection, it can then use any one of the four TBASIC commands: READMODBUS, WRITEMODBUS, READMB2, WRITEMB2 to read or write data to the remote devices via the virtual comm. port #4, as if a Modbus slave device has been locally connected to a COMM4 port of this PLC. (You do not need to distinguish between Modbus ASCII and RTU in this case, simply use comm. port #4 in your all your commands).

Multiple Modbus master commands can be sent as long as the connection is live. You can test the connection status by checking the result of the STATUS(3) function at any time.

Once all the command exchanges have been completed, you should send a </> tag to close the client connection to the remote server so that other NS commands can be executed in other parts of the program.

**Example:** Please refer to the "fnMBTCP", "fnRdMBTCP" and "fnWrtMBTCP" custom functions in the demo program: "TestEthernet.PC6".

## 2.6 Getting data from Internet: Connecting to The Internet Time Server

The Nano-10 PLC features a special NS command tag <TCPCONNECT xxx.xxx.xxx.xxx: portno> that allows you to connect to any server to download data. However, since the PLC does not have a lot of memory for storing incoming text data, it is not suitable for downloading information from a commercial website that sends many kilobytes of data in a single download. It can however, be very useful to connect to some servers that send small amounts of information. For example, there are many Internet Time Servers on the Internet that allow users to synchronize their computer clocks via the Internet. The service responds to time requests from any Internet client in several formats, including the DAYTIME, TIME, and NTP protocols. The simplest are those that send responses in ASCII data and you can extract the date and time information from the response ASCII string once you know the format.

You can search on the Internet for a suitable timeserver and use the TELNET program on your PC to access them to examine their display format. Most timeservers listen either on port 13 or port 123 so you need to specify the port number together with their IP address when sending the <TCPCONNECT> command.

**Format:** <TCPCONNECT [IP address:portno] of time server>

**Response:**

- none -	Successfully connected to the Modbus/TCP server of the specified IP address.
ERR:05-Prev Conn.ON	Another NS command has been executed and left the client socket opened but did not execute the PRINT #4 "</>" to close the client socket.
ERR:04-Not Connected	Failed to connect to the targeted server.

**STATUS(3):** This TBASIC function returns 1 if connected, or 0 if connection fails..

**Description:** Once a connection is made, you can then interact with the remote server using the PRINT #4 and INPUT\$(4) command. You use the INPUT\$(4) command to read CR-terminated text strings sent by the server. You can also send data to the remote server using the PRINT #4 command.

**Example:** Please refer to the "fnTCPconn1" custom function in the demo program: "TestEthernet.PC6" to see an example of how the PLC can connect to an NIST timer server and use the returned data to update the PLC's real-time clock.

A better, standalone program "TimeServer.PC6" can also be found in the Nano10Samples.zip folder. This program not only updates the time but also updates the calendar and computes the time zone and adjust for daylight saving time automatically.

**Note:** Some NIST time servers have strict policy against abuse so you should avoid sending repeated request within a short period of time, otherwise further connections may be denied once you are considered to have violated their connection policy.

## 2.7 Web Service: Accessing PLC's data from MS Excel

The FServer provides an extremely useful feature called “Web Service”. You can actually use your web browser to access the Nano-10 PLC internal data by specifying the following URL:

<IP Address: portno of FServer>/HOSTLINK/<Point-to-point hostlink command without “\*”>

E.g. Please enter the following URL into your web browser URL address space:

192.168.1.5:9080/HOSTLINK/IR

You will see the following data appear on your browser screen:

IR01

“IR” is one of the many “host link commands” that allows a host computer to read or write to the PLC’s internal data space using ASCII strings. This particular command “IR” is for reading the PLC’s ID and in this case the PLC returns “01” by default. For more details on the list of host link commands, please refer to [Chapter 15](#) of this manual.

Normally the host link commands are sent to the PLC via the serial port (as per all other PLC models produced by TRI). The FServer, however, permits these host link commands to be sent using the HTTP protocol, which enables the Nano-10 and F-series PLC to be easily accessible by enterprise software using what is known as “Web Query” methods. The enterprise software only needs to know the format of the host link command required to read the target data and then they can use their web query capability to query the PLC and extract the required data from the response string.

One example, which you can try immediately, is to use the Microsoft Excel 2000 (or later version) spreadsheet program. First, open a blank spreadsheet, then click on the “Data” menu and select “Get External Data” -> New Web Query, as shown below:

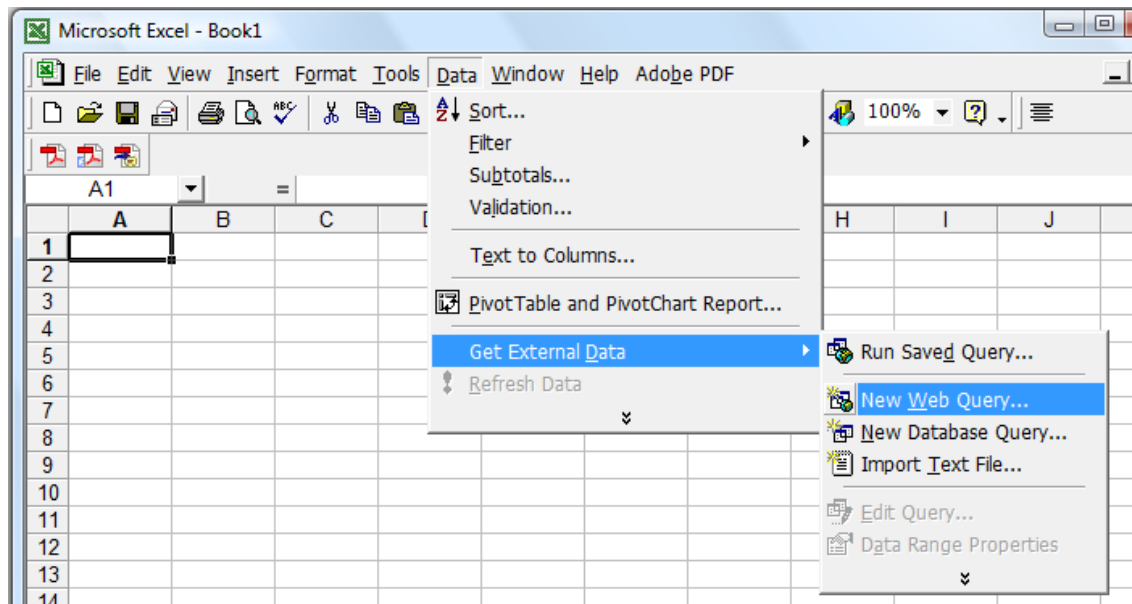

Figure 2.6.1

Next, please enter the text as shown in the following diagram and then click OK. This will command the Excel spreadsheet to send the web query string “RI00” to the Nano-10 PLC that is connected to the network with IP address = 192.168.1.5 and port 9080. The query string “RI00” is for reading the status of 8-bit input channel #0 (which covers the logic states of input bit 1 to 8).

If the FServer is accessible by the PC from the network router, it will send the response data, which will be displayed on the selected spreadsheet cell where the New Web Query was defined earlier.

The response data shown on the cell could be RI00. The response data includes the command header “RI” as defined in the HostLink Command protocol described in [Chapter 15](#). The data 00 indicates that none of the inputs 1 to 4 are currently turned ON.

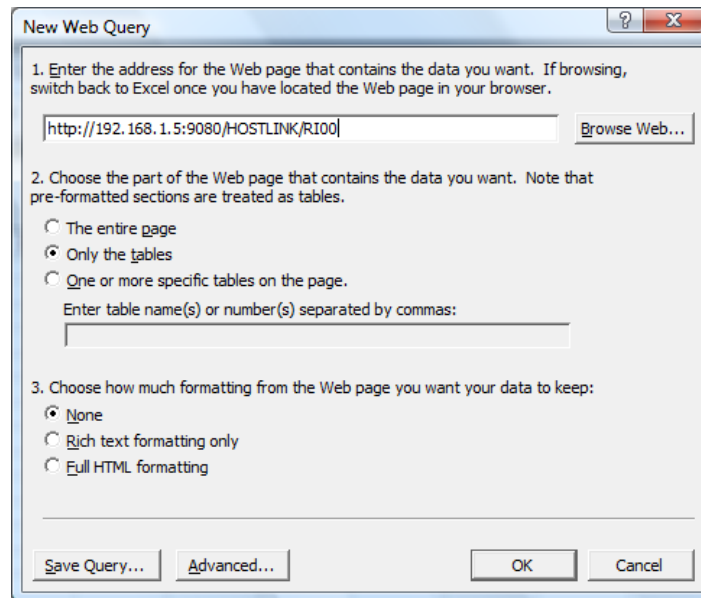

Figure 2.6.2

To see how the response data changes in response to the actual PLC’s input, please turn on some of PLC’s digital inputs 1 to 8, then right-click on the cell where the web query was defined and select the “Refresh Data” command. You should see a new “RIX” string appear at the selected cell where “XX” is the hexadecimal representation of the 8 input bits 1-8. E.g. if only inputs 2 and 8 are turned ON, then the binary pattern is 1000 0010 which in hexadecimal form is 82 and the response string would therefore be “RI82”. You can then write an excel formula to extract the data “82” and use it for your other computation purpose. By using a different Host Link command, the Excel spreadsheet can read and write to the PLC’s internal data very easily.

#### Notes:

1. If you have enabled “Use Username/Password” for the FServer, you will be prompted by your Excel program to enter the Username and password before you can receive the response data.
2. We have provided a more complete Excel spreadsheet example “ExcelQuery.xls” which can be downloaded from: <http://www.tri-plc.com/appnotes/F-series/ExcelQuery.xls> The macro in this file converts the RIXX data it receives into ON/OFF indicators on the Excel Spreadsheet cells. Note that this spreadsheet file uses the “HEX2DEC” function that is not normally available when you first install the Excel program. But you can add it in by installing the “Analysis Toolpak”. Please search your Excel Help file for the specific method of adding in this toolpak as it may change from one version of Excel to another. On Excel 2000, you can click on the “Tools->Add Ins”, check the “Analysis Toolpak” check box and then click OK. MS Excel will automatically install the toolpak for you.

## 2.8 Accessing The PLC from Internet

### 2.8.1 Small Local Area Network Using Consumer Grade Network Router

When you connect an Nano-10 PLC to your home Ethernet router, the PLC would have joined a “private” local area network (LAN). It is accessible, through its private static IP address, by other devices on the same LAN as long as each device is on the same “subnet” (See section 2.1 for an explanation of subnet settings). The PLC is also able to access the Internet through the router because the router would translate a private TCP/IP packet sent from the PLC into a public TCP/IP packet out of the Internet and if there is any return data from the Internet meant for the PLC, the router would know that and automatically routes the return packet back to the PLC. The router performs what is known as “Network Address Translation (NAT)” and such routers are called NAT routers.

However, the same FServer and Modbus/TCP servers on the PLC are typically inaccessible from the public Internet. This is because the router has a built-in firewall that does not permit external TCP/IP packets from the public Internet to reach the devices on the private LAN. In other words, the NAT router allows the PLC outgoing access to the Internet but by default does not allow incoming access.

Most small NAT routers for home use such as those produced by Linksys, Netgear, D-Link or Belkin do allow you to configure the router to “open” and “forward” a specific port number to a specific device on the private network. For example, if your PLC static IP address is 192.168.1.5 and you wish to open its FServer port (9080) but not its Modbus/TCP port (502) to the public internet, you would configure your router such that it will forward the incoming TCP/IP packet destined for port number 9080 to the device at IP address 192.168.1.5. Once you have done that, you will then be able to access the FServer from the Internet using the router’s public IP address (this is typically assigned by the Internet Service Provider) and the port number 9080. However, the Modbus/TCP port is not accessible from the Internet since this port number is not opened and not mapped by the router.

You should read your router’s User’s Manual to find out how to configure the router to perform the “port forwarding” described above since each router model has a different user interface. For example, on the D-Link DI-624 router you configure the router by clicking on the “Advanced” tab and selecting “Virtual Server” from the router configuration page, as shown below:

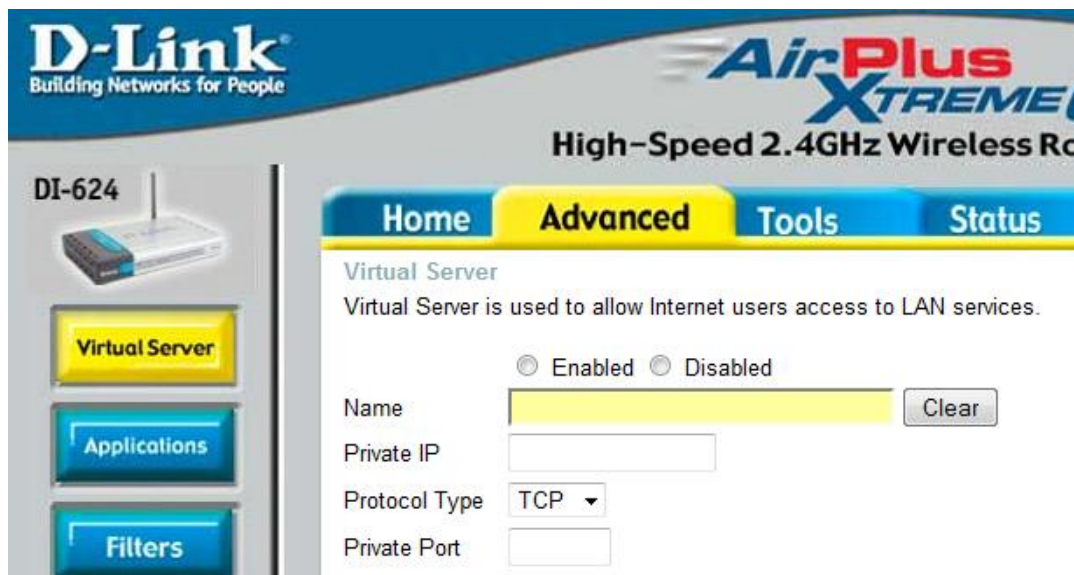

On the Linksys WRT54G router, you would configure it from the “Applications & Gaming” menu under the “Port Range Forward” tab, as shown below:

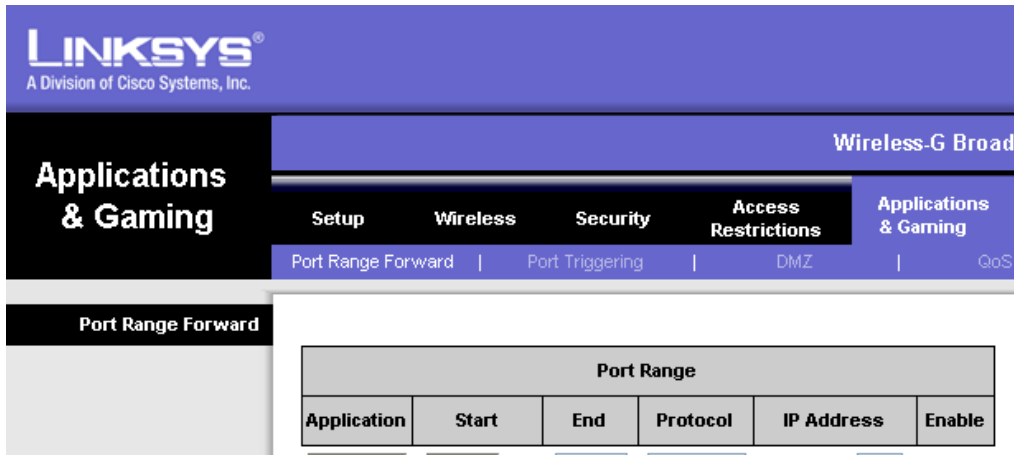

## 2.8.2 Large Corporate Local Area Network

In the case of a medium to large corporate LAN, whether incoming and outgoing TCP/IP packets are allowed to go through the corporate firewall is entirely decided by the System Administrator according to the company's security policy. Most corporate LANs will not allow incoming packets from reaching an internal server until the System Administrator has given the permission to do so. Some company's network may not even allow devices such as the PLC to open a connection to the Internet to access external data. If your application requires the PLC to access the Internet or to be accessible from the Internet, then you would need to consult your system administrator on the required procedure.



## 2.9 Installing a Web Page or Web Applet into the Nano-10 PLC using FileZilla

The Nano-10 PLC web server space can host up to 60 kilobytes of data files which can be HTML, JPG, JS (JavaScript) files etc. This can be expanded by 256kb of additional file space using the [FRAM-RTC-256](#) module.

Thanks to its support of the “web services” commands, a programmer can create its own sophisticated control webpages using only standard HTML and JavaScript .

TRi has created an example control webpage which can be downloaded from:

<http://www.tri-plc.com/download/webapp/webapp02.zip>

When you have successfully unzipped all the files from the Webapp02.zip into your hard disk, you will need to transfer the files to the PLC’s web server using a FTP client program. The following sections describe how to use the free FileZilla FTP program to transfer these files and [section 2.10](#) will describe how to customize the control web pages.

**NOTE:** The “M.JS” JavaScript file used with the new preloaded 0.HTM file is no longer provided in the new web app download because it is loaded remotely. In the past, M.JS had been stored inside the PLC and was available directly for editing. However, now the user modifications in the HTML file are more expanded and in order to save space for additional files as well as protect against accidental modification of the M.JS file, it is now stored outside PLC memory.

If you are an experienced web programmer, or you plan to outsource web programming services to customize your PLCs web interface, then you may obtain a copy of this file for more advanced editing by writing to [support@tripc.com](mailto:support@tripc.com) and providing your purchase references (purchaser’s name, company name, invoice # etc).

Of course, you may also like to build your own HTML and JavaScript/Jquery control structure, which is entirely feasible for any experience web programmer.

Users only need to refer to [chapter 16](#) in this manual for the list of Hostlink commands to be sent in web query form (refer to [section 2.7](#)) in order to implement web based data exchange with TRi PLCs.

### 2.9.1 Installing the FileZilla program

First please download the FileZilla client from: <http://filezilla-project.org>

Once you have gone to the web page from the above link, you will need to select the client version to download. Then you need to select the software version for your computers platform, typically the Windows version, and download it to your computer. This is the installation setup file, which you will need to execute after it has downloaded. Please perform a default installation by following the installation steps.

### 2.9.2 Configuring FileZilla to Communicate with the Nano-10

After installing the FileZilla client, please open it from the start menu or desktop icon and then go to the “File” menu and select “Site Manager”. The following menu will then pop up:

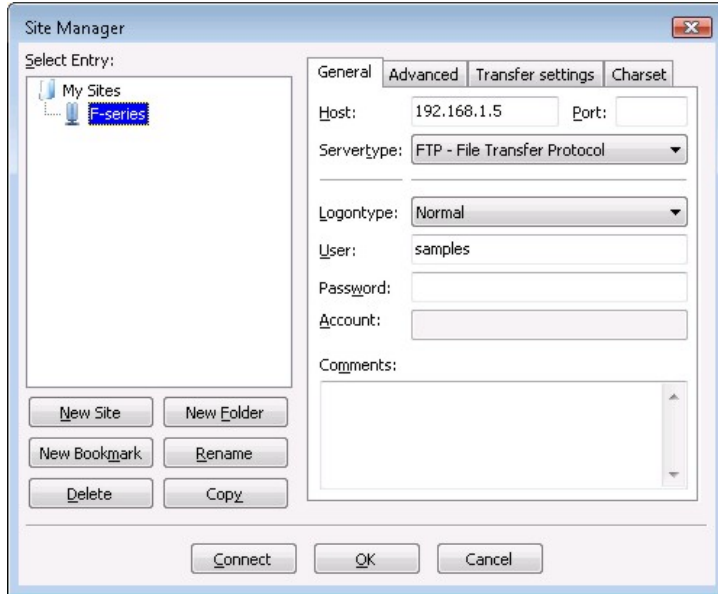

Figure 2.9.1

Under the default “General” tab, you will need to enter the Host IP address and configure the “Logontype”.

The Host should be the IP address of the Nano-10 PLC (default IP is shown in the example). The Port can be left blank and the Servertype can be left as the default as shown.

The Logontype should be set to Normal and the User and Password should be set to the same as for the login to the Nano-10 Server in the Ethernet port.

Nothing else needs to be configured in this area. Next go to the “Transfer settings” tab.

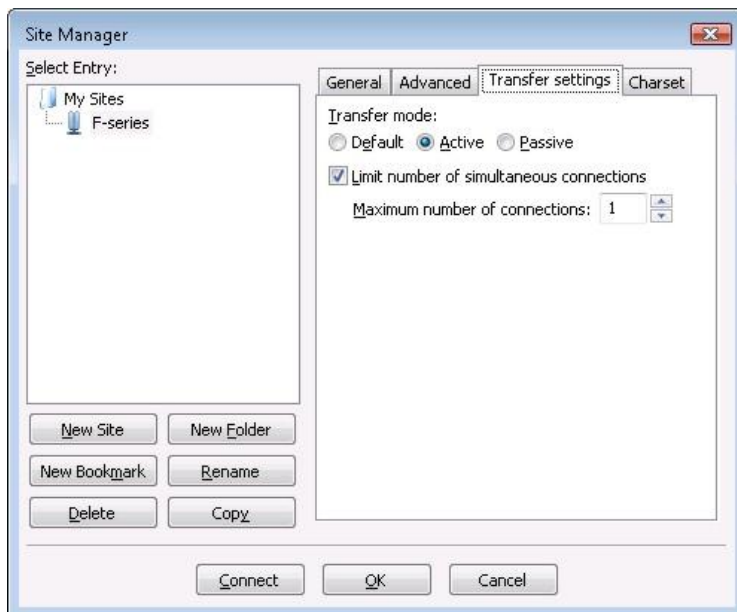

Figure 2.9.2

Under the “Transfer settings” tab you need to set the Transfer mode to “Active” and check the box to Limit number of simultaneous connections. The maximum number of connections should be 1.

This is everything that needs to be configured, so you can now click on connect.

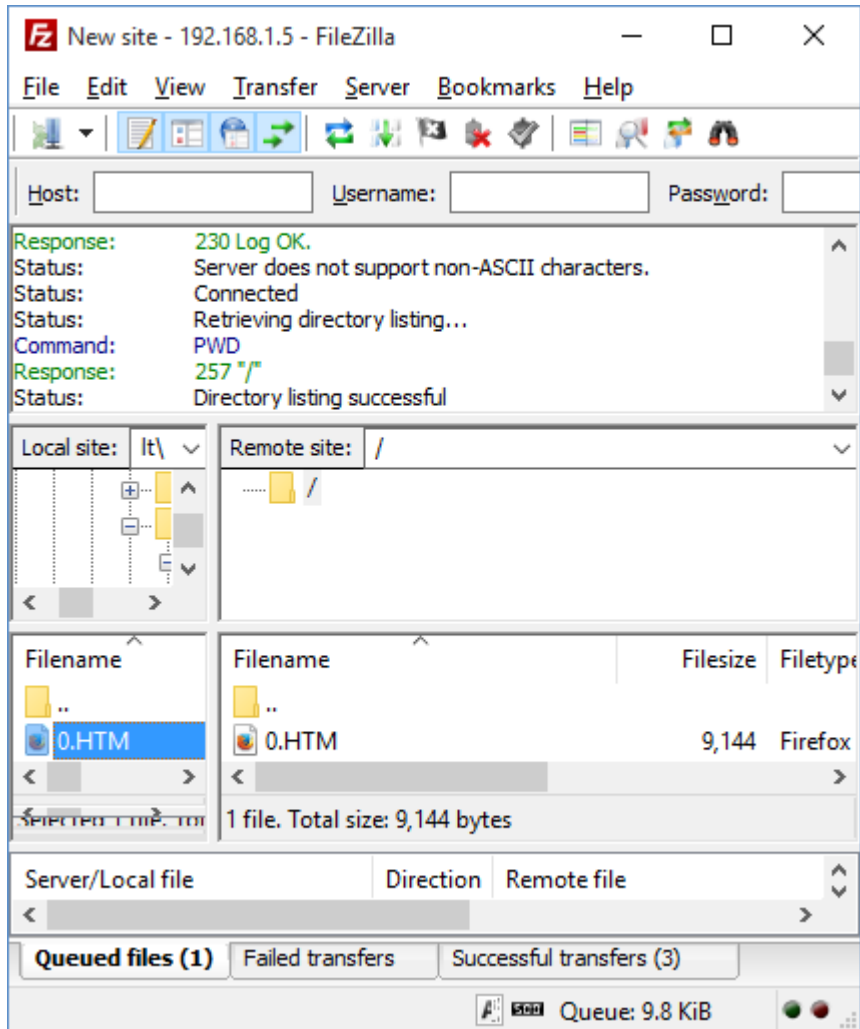

Figure 2.9.3

If FileZilla has made a successful connection, the status should be: "Connected", and "Directory listing successful".

Also, you should be able to see the preloaded file "O.HTM" in the remote site directory, which is the bottom right window shown here.

If you are not able to connect to the Nano-10 server or if you can't get a successful directory listing, then you should first double check the settings you have configured for FileZilla compared to the settings configured in the Nano-10 server. The next thing to check is your Windows firewall. You can disable the firewall temporarily to check if it is affecting your FileZilla connection, but it is not recommended to leave your firewall disabled. If you have confirmed that disabling the firewall allows you to successfully connect to the Nano-10 server and view the directory listing, then you can add FileZilla to the firewall exception list so that you can leave your firewall enabled.

To add FileZilla to the Windows firewall exception list, you will need to open the Windows firewall from your network settings configuration area. Then you will need to click on "Change settings", which will open up a new window. You will need to go to the "Exceptions" tab in the new window and look for FileZilla in the list of programs. If you see FileZilla in the list, then you will need to check the box beside it to add it to the exception list. Otherwise, you will need to manually add it to the list by clicking "Add program" and searching for FileZilla in its installation directory. Here is a picture of the Windows Firewall status window and the Change settings window with the Exceptions tab:

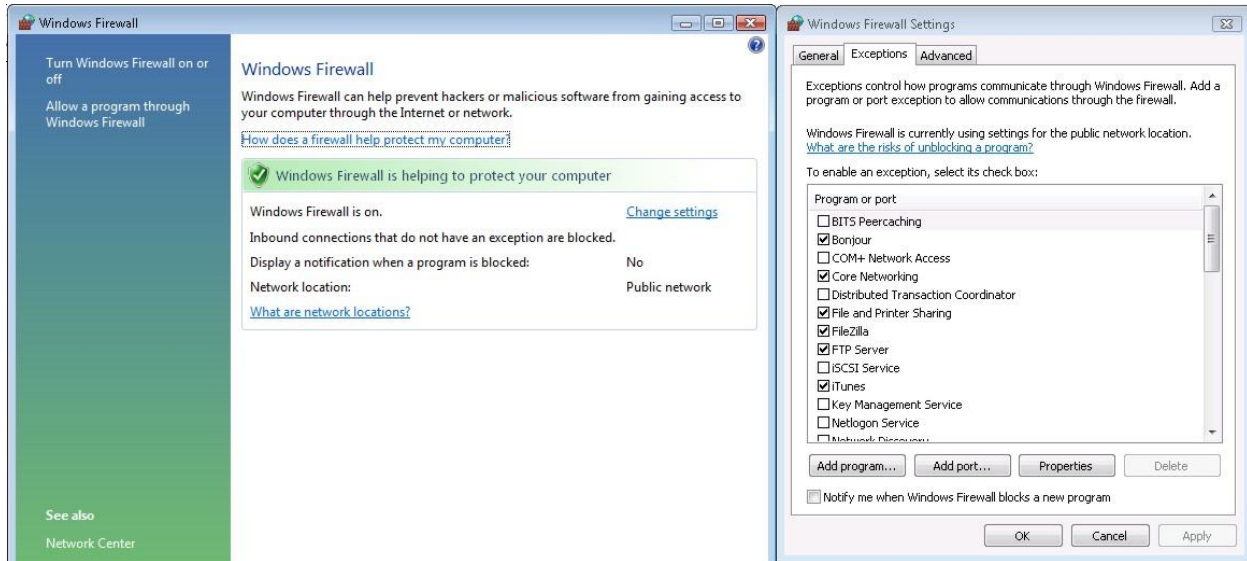

Figure 2.9.4

### 2.9.3 Transferring and Retrieving Files from the Nano-10 Web Server

Now that you have a connection to the PLC's web server and can view the directory listing, you should be able to see the preloaded file: "0.HTM"

#### Downloading Files

The first thing to do is download the preloaded file from the Nano-10 server and store it somewhere on your computer. To do this you will need to open up the folder on your computer that you want to store the file in. Then you can drag the file from the Nano-10 web server via FileZilla into your destination folder. It is best to make a copy of this file as a backup on your computer so that you have the original copy available in case you need it.

Now you can make any necessary changes to the 0.HTM (this is explained further in section [2.10](#))

#### File Names

Note that the filenames are important. The 0.HTM file can be renamed (outside of the PLC's Web Server) with or without the ".HTM" extension, but there are limitations. There is a very simple, pre-configured file system in the Nano-10 web server that is implemented as follows:

- Files can have the name "0" through "9" (one digit) or "A" through "M" (one character)
- Files can have any extension (".HTM" is used for the pre-loaded files), but only a few MIME types are respected. These include HTM, JPG, GIF, CSS, JS, BIN, TXT, JAR. From firmware version r77 onwards the following MIME type are also supported: ZIP, XLS. Any unsupported extension will be converted to "???".
- There is 2Kb of reserved space for each File "0" through "9" and "A" through "T"
- If the HTML file is more than 2kb, then more than one file space will be used.
- If a file takes up multiple 2kb locations and another file is added within one of the used locations, the larger file will be corrupted and no longer accessible.

For Example, the file "0.HTM" is about 3.5kb so it takes up two 2kb locations ("0" and "1"), so the next file should be "2.HTM" or higher. If you attempted to add a file named "1.HTM", it would corrupt "0.HTM" but "1.HTM" would work.

### Uploading Files

When you are ready to transfer your modified .HTM file, you just need to drag it from the folder it is saved to on your computer into the bottom right window of FileZilla where the current files are shown. If you didn't change the filename, you can tell the new file to overwrite the old file. Otherwise, you will need to manually delete the old file "0.HTM" from the Nano-10 web server in FileZilla by right clicking on it and selecting Delete.

## 2.9.4 Download the Web Page Files

If you have modified the original "0.htm" file that was preloaded in the Nano-10 server and need to retrieve the original file, it is possible to download them from the following web page:

<http://www.tri-plc.com/download/webapp/webapp02.zip>

## 2.9.5 Troubleshooting FileZilla File Transfer Problems

### 1) **FileZilla appears to have connected to the PLC's FTP server, but it cannot list the directory or transfer any file to the PLC.**

The reason almost always have something to do with the PC's software firewall. You need to configure the Windows Firewall (and any software anti-virus firewall on your PC) to allow incoming connections to the FileZilla program. You can try to disable the firewall temporarily to test the connection and if does work, you can then be sure that it is the firewall configuration issue that need to be resolved.

The following paragraphs explain how the firewall can affect the FTP communications for those who are interested:

The File Transfer Protocol is unique in that it requires **two** socket connections between two devices that are communicating via FTP. When FileZilla is connected to the PLC's FTP server on port 21, it establishes a "command" channel and it is thru this command channel that FTP commands are being sent.

However, once the command channel is established (FileZilla is "connected" to the FTP Server), a second socket connection (known as the "data channel") needs to be made between FileZilla and the PLC. All data, such as the directory information and content of any files to be transferred between FileZilla and the PLC will need to go through the data channel. They are two possible ways of establishing this data channel, one is called the "Active Transfer" and the other is known as "Passive Transfer".

FileZilla is able to operate in either transfer mode, but the PLC FTP Server can only operate in "Active Transfer" mode. "Active Transfer" mode requires that the client (FileZilla) provides a listening socket for the server (PLC) and the server (PLC) will then try to connect to this socket to establish the data connection. So if the FileZilla program sits behind the software firewall and no exception has been configured, then the PLC FTP Server will not be able to make a connection to the FileZilla data socket because it is blocked by the firewall and the connection will therefore fail. This explains why FileZilla seemingly able to connect to the PLC but yet is unable to send any data or list the directory – because there is no data channel connection for it to do so.

However, sometimes the problem could persist after disabling all firewalls and in that case the only option is to revert to an older version of FileZilla, and then transfer the files by doing a right-click download or right-click upload (if drag and drop doesn't work). You can do this as follows :

- a. Download the FileZilla client version 3.1.5.1 from <http://www.oldapps.com/filezilla.php>
- b. Remove the current version and then install version 3.1.5.1
- c. Connect to the PLC
- d. There should be two directories (same as always) : local site (your PC) and remote site (Nano-10). You should see your files in the Nano-10 directory.
- e. Open the folder in the local site that you would like to save the Nano-10 files to.
- f. Right click on a file in the Nano-10 directory such as 0.HTM and select download. You should see the file in the folder on your local site.
- g. To move files from the PC to the Nano-10, open the folder in the local site where the file is located and right click it to select upload. You should see it in the Nano-10 or you will be asked to overwrite it if the same file name is there already.

### 2) FileZilla Can Connect The First Time But Could Not Re-connect After Time-Out

FileZilla is normally setup to time out after 1 minutes of no activity. However, Since the PLC's FTP server can only handle a single FTP connection at a time, it is good to avoid letting FileZilla time out due to no activity. This is because when FileZilla times out it cutoff the connection to the PLC. But if for whatever reason the PLC were to miss the disconnection information it will be left in a "half-open" state and will not be able to accept a new connection. When this happens and if you try to reconnect to the PLC again after the connection has been dropped by FileZilla, you will most likely be unable to connect to the PLC again until after the PLC time out its FTP connection due to no activity. The only quick fix is to power-on reset the PLC so that it starts up fresh and can accept new connection again.

You can set the FileZilla timeout settings to a larger number (e.g. 300 seconds) using the FileZilla's "Edit->Settings" menu item so that it will not time-out automatically too quickly. You should always select "disconnect" after a file transfer to properly close the connection and then the PLC will be properly disconnected and is ready to accept new connection.

### 3) Problem Using FileZilla To Transfer Files to Multiple PLCs Configured To The Same Default IP Address Even Though Only One PLC Is Connected To The Router At A Time.

When you connect FileZilla to a PLC with a particular IP address (e.g. 192.168.1.5) for the first time, Windows will memorize the MAC-ID address of that PLC and associate it with this IP address in its "ARP cache" (ARP = Address Resolution Protocol). So when you power off one PLC and immediately plug another PLC with the same IP address to the network, then Windows will pass to FileZilla the MACID of the **PREVIOUS** PLC instead of the new PLC using data in its ARP cache memory. When FileZilla tries to connect to the right IP address but a wrong MACID, it of course would not be able to connect properly.

In such a scenario, you must clear the Windows ARP cache first using a command prompt as follow:

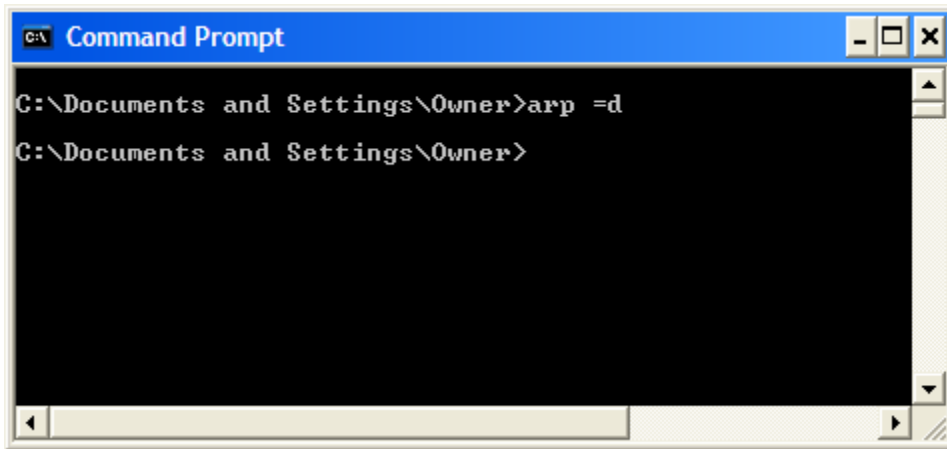
A screenshot of a Windows Command Prompt window. The title bar reads "C:\ Command Prompt". The command prompt shows the current directory as "C:\Documents and Settings\Owner" and the command "arp -d" has been entered and executed. The prompt is now "C:\Documents and Settings\Owner>".

```
C:\ Documents and Settings\Owner>arp -d
C:\ Documents and Settings\Owner>
```

The “**arp -d**” command tells windows to delete its ARP cache data. So when you use FileZilla to connect to a new PLC Windows will do the necessary to properly connect to the new PLC that has a different MACID from the previous PLC.

Note that the same issue applies to using I-TRiLOGI to transfer program to multiple PLCs that are all set to the same default IP address, even though only one PLC will be connected to the network at a time. You will need to clear the ARP cache after every transfer to avoid problem. Or else you have to wait for windows to expire its ARP cache data before connecting the next PLC.

## 2.10 Accessing and Customizing the HTML Web Interface for Control and Monitoring

The second generation of Web control application is now available free for any TRi PLC user to download and install into their PLC. In the previous section ([2.9 Installing a Control Web Page Into the FMD PLC](#)) you were shown how to transfer html files to the FServer.

Click on the following link to download this new web application.

<http://www.tri-plc.com/download/webapp/webapp02.zip>

The “Webapp02.zip” file you downloaded above (or in Section 2.9) for the Nano-10 PLC contains two folders:

- 1) WebApp-FMD&Nano10
- 2) WebApp-FxPLC

Select 1) WebApp-FMD&Nano10, which contains the following:

- Sample control web page (0.HTM)
- A readme file (Readme.txt)
- A download link (UserGuide.htm) for the quickstart modification guide
- PLC program file for TRiLOGI 6 (webAppTest.PC6) that can be loaded in the PLC

The user guide describing how you can modify the control webpage can be downloaded directly from:

[http://www.triplc.com/documents/WebApp\\_UserGuide.pdf](http://www.triplc.com/documents/WebApp_UserGuide.pdf)

This is also discussed on the TRi support forum:

<http://www.triplc.com/yabbse/index.php?board=2:action=display:threadid=2090>

### 2.10.1 Next Generation of Super PLC Web Control

These web files can be accessed from any standard web browser that supports AJAX technology (Internet Explorer, Firefox, Chrome, Safari) locally as long as your NANO-10 PLC is connected to the LAN (local area network) or from anywhere in the world as long as your NANO-10 PLC is connected to the Internet. Even the iPhone, Android phones, and other smartphones that support AJAX can be used to access these web pages, which means your application can be controlled and monitored from anywhere while on the go.

This new version makes use of the newer JQuery UI and no longer utilizes the M.JS JavaScript file. Instead it calls the JQuery file remotely (no longer stored inside the PLC).

Either way, the web files are only accessible from standard browsers that support AJAX technology. However, the HTML files are designed to be easily modified by anyone, even if you don't have any programming experience. The purpose is to be able to easily customize the web page layout for your specific application by defining some label names and a background image without having to worry about the programming required to interface to the PLC, which is already taken care of.



The basic HTML file “0.HTM” is the file where simple modifications can be made. All of the provided HTML files are actually 0.HTM because only the first character of the name is used, so 0-C001-02.HTM becomes 0.HTM (this example refers to the files in the Fx Web App folder).

The first release of this new Web control application accepts up to: 16 I/O buttons linked to Relay #128 to #144; 16 floating point FP[] variables (only supported on Fx and EZWire PLCs); 16 DM[] variables, and 8 sliders that can be attached to display and/or control any of the FP[1] to FP[16] (not applicable to NANO-10 PLCs) or DM[1] to DM[16] variables. Any of these control elements can be selectively displayed and their position, size and color are all user customizable using a simple text editor, with no programming required at all. See below for a screenshot of 0.HTM.

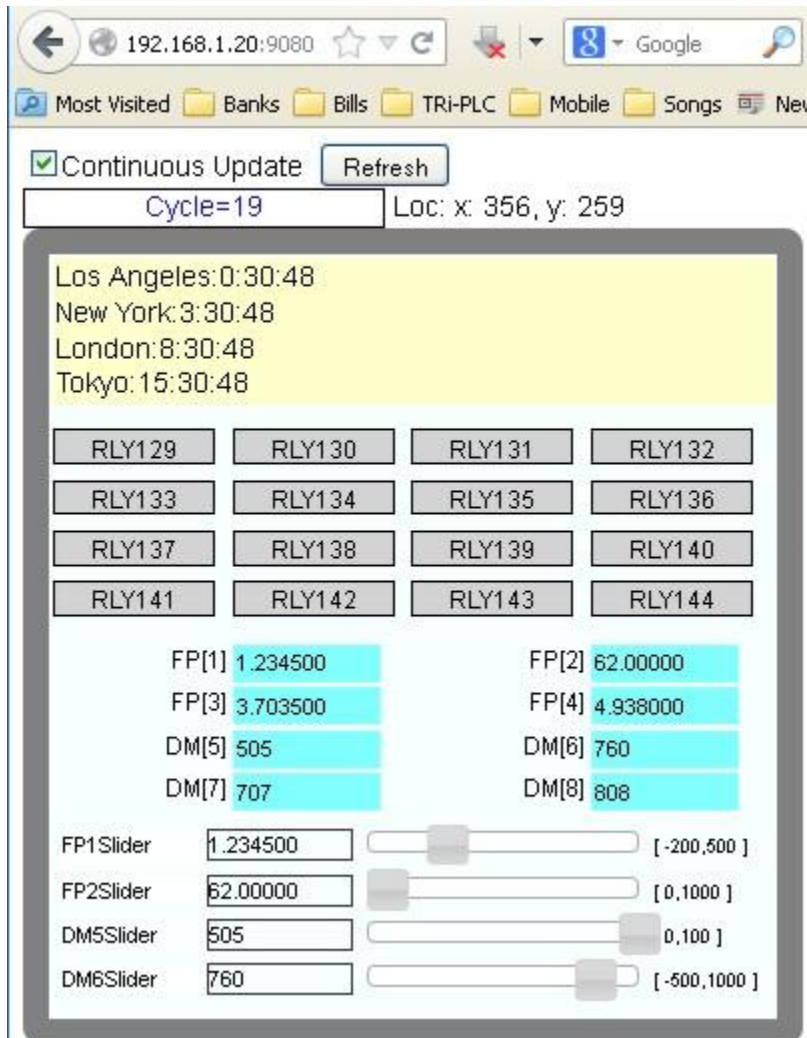

Refer to the user guide linked above for more information on the available user modifications.

## 2.10.2 Advanced Customization

The “M.JS” JavaScript file used with the new preloaded 0.HTM file is no longer provided in the new web app download because it is loaded remotely. In the past, M.JS had been stored inside the PLC and was available directly for editing. However, now the user modifications in the HTML file are more expanded and in order to save space for additional files as well as protect against accidental modification of the M.JS file, it is now stored outside PLC memory.

If additional modifications need to be made beyond what can be done in the HTML file, then the following two options are available:

**1) Enlist Design Services**

Contact our Solution Partner, [Sparrow Design LLC](#), for browser/app control design services.

**2) Request the JavaScript Files.**

If you are an experienced web programmer, or you plan to outsource web programming services to customize your PLCs web interface, then you may obtain a copy of this file for more advanced editing by writing to [support@triplc.com](mailto:support@triplc.com) and providing your purchase references (purchaser's name, company name, invoice # etc).

Of course, you may also like to build your own HTML and JavaScript/Jquery control structure, which is entirely feasible for any experience web programmer.

Users only need to refer to [chapter 16](#) in this manual for the list of Hostlink commands to be sent in web query form (refer to [section 2.7](#)) in order to implement web based data exchange with TRi PLCs.

## Chapter 3 Digital I/O and Internal Relays Programming

## 3 DIGITAL I/O AND INTERNAL RELAYS PROGRAMMING

### 3.1 Introduction

Although the Nano-10 PLC has only 4 physical Digital Inputs and 4 Digital Outputs, all additional input and output bits that are supported by the i-TRiLOGI software are still available to the Nano-10 PLCs as internal inputs and output bits. Nano-10 also supports all 512 internal relays available in both ladder logic and BASIC.

---

### 3.2 Programming DIO with Ladder Logic

The physical I/O and internal relays can be programmed in ladder logic in a few simple steps.

#### 3.2.1 For Physical I/O

1. Create or Edit the label names
2. Place the input contact(s) into the ladder logic circuit
3. Place the output coil at the end of the ladder logic circuit

#### 3.2.2 For Internal Relays (Non-Latching)

1. Create or Edit the label names
2. Place the relay contact(s) into the ladder logic circuit
3. Place the relay coil at the end of the ladder logic circuit

#### 3.2.3 For Internal Relays (Latching)

1. Create or Edit the label names
2. Place the activating input/relay contact into the ladder logic circuit
3. Place the latching relay in parallel with the activating contact
4. Place the relay coil at the end of the ladder logic circuit

### 3.2.4 Programming Examples:

#### 3.2.4.1 Example 1 – Editing Label Names

The Digital I/O can be named by selecting “I/O Table” from the “Edit” menu and choosing the particular digital I/O that you want to name. In Figure 3.1, physical input #1 is being named “Input1”.

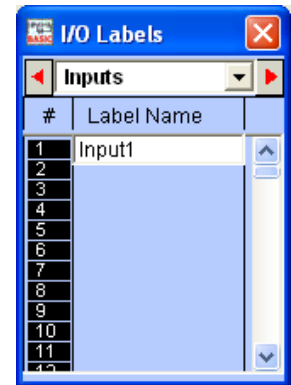

Figure 3.1: I/O Table

#### 3.2.4.2 Example 2 – Creating a Simple Ladder Logic Circuit

You can place components in the circuit by clicking in the green area to the right of the red arrow, as shown in Figure 3.2 below. This will bring up the component tool bar in the gray area above the green circuit area.

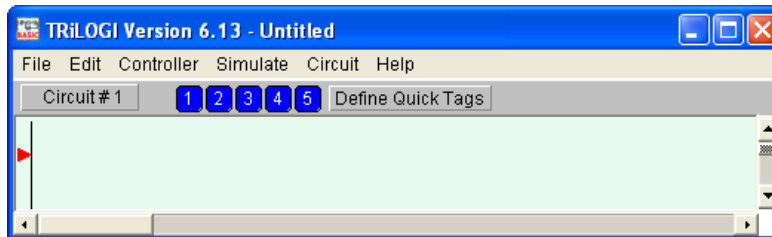



Figure 3.2: Creating Ladder Circuit

Once the component toolbar is shown, you can place your input/relay contact by selecting the #1 component from the toolbar  and then selecting the digital input from the I/O Table. The contact will then be automatically placed in the ladder logic circuit. The same can be done for the output coil by selecting the #7 component from the toolbar  and then selecting an output that has been entered into the I/O Table. After selecting one input and one output, the ladder logic circuit should look like something like Figure 3.3, below:

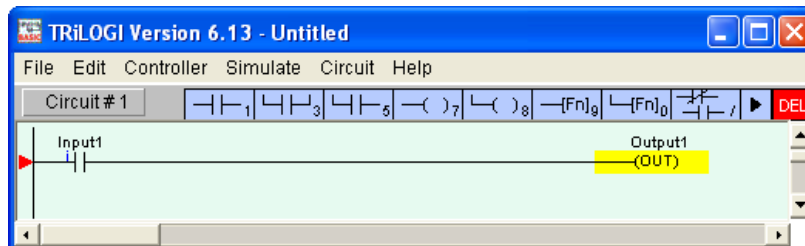



Figure 3.3: Completed Ladder Circuit

#### 3.2.4.3 Example 3 – Creating a Latching Relay Circuit

The first part of the circuit follows the same procedure as the previous example, except that the #7 coil should be a Relay coil. So it should look similar to the circuit in Figure 3.3. The next part requires a parallel contact to be added to the Input1 contact. This is done by selecting the Input1 contact (or whichever contact was used) and then adding the #3 contact , as shown in Figure 3.4 below.

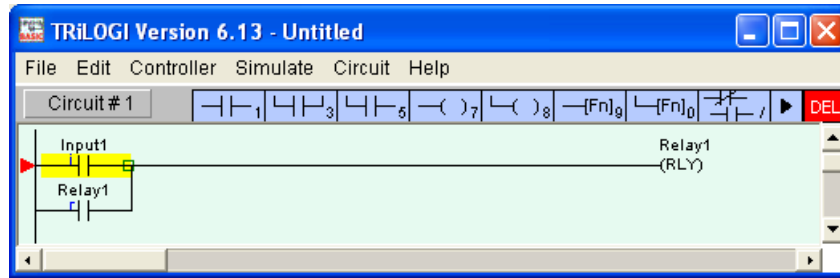

Figure 3.4: Completed Latching Circuit

### 3.3 Programming DIO in a Custom Function

In order to program digital I/O or anything in a custom function, a custom function must be created in the I/O Table and added in a ladder logic circuit. Custom functions act the same way as coils in ladder logic, in that they need a contact to activate them. Once they are activated, the code inside them will execute.

To create a custom function circuit, follow these 3 steps:

1. Edit the name of the custom function in the I/O Table
2. Place the activating contact in the ladder logic circuit
3. Place the custom function at the end of the circuit

#### 3.3.1 Editing Label Names:

This is the same as for the digital I/O, except that the I/O table window needs to be scrolled to the custom function area for editing custom function names.

Placing the custom function in the circuit is done the same way as other ladder logic contacts and coils, by selecting the  $\{Fn\}_g$  and then choosing the Differential custom function  $\{dCusF\}$  from the pop-up window

D. {CusFn} - Custom Function  
 E. {dCusF} - Diff. Up Custom Funcs  
 F. [MaRST] - Master Reset

The circuit should look something like below:

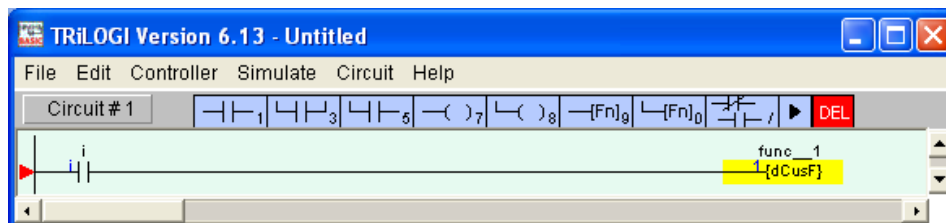
Figure 3.5: Circuit with custom function  $\{dCusF\}$ 

#### 3.3.2 Controlling I/O from Custom Functions:

An empty custom function looks like this:

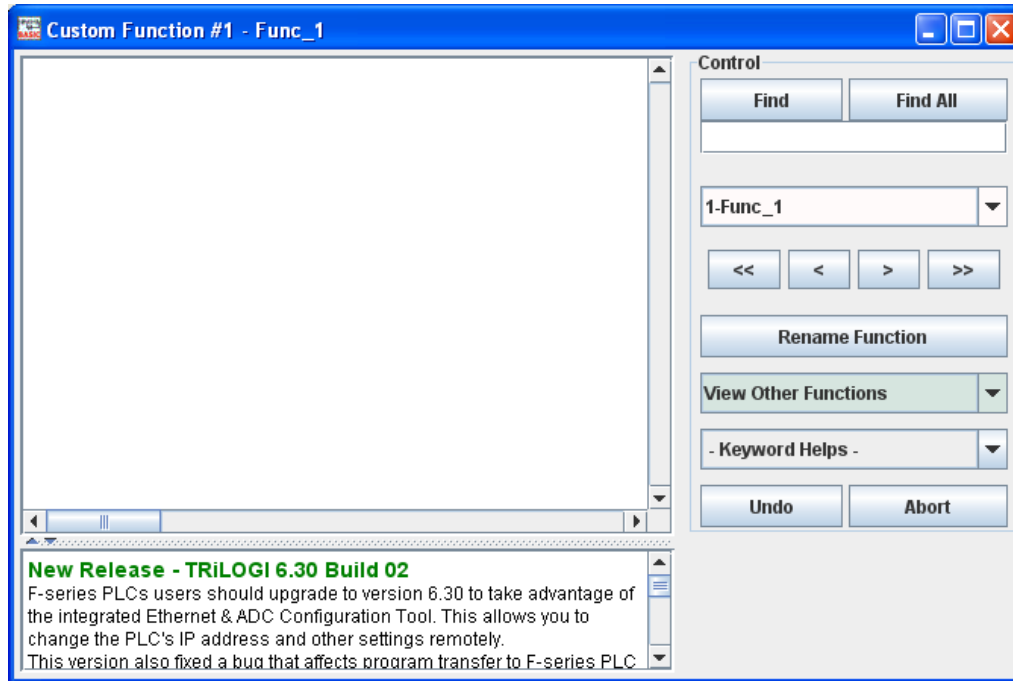

TBASIC code is entered into the custom function, which allows the possibility of total control of all of the PLCs functions and hardware.

There are 7 TBASIC functions available to control all of the digital I/O, which are:

1. SETIO *labelname*
2. CLRIO *labelname*
3. TOGGLEIO *labelname*
4. TESTIO (*labelname*)
5. SETBIT *v,n*
6. CLRBIT *v, n*
7. TESTBIT (*v, n*)

Each function has its own advantage depending on what needs to be done to a digital I/O. Each of these functions is explained in the programmer's reference manual, which should be referred to for further information. Here are some examples of how to control digital I/O using these functions.

### 3.3.3 Example 1 – Turn on/off an Output

This can be done using both the SETBIT *v,n* / CLRBIT *v,n* command and the SETIO *labelname* / CLRIO *labelname* command.

1. Using SETBIT *v,n* / CLRBIT *v,n*

```
SETBIT OUTPUT[1], 0    'This will turn on the first output using the output[] register
CLRBIT OUTPUT[1], 7    'This will turn off the 8th output using the output[] register
```

2. Using SETIO *labelname* / CLRIO *labelname*

```
SETIO out1    'This will turn on the output out1
CLRIO out5    'This will turn off the output out5
```

In this case, out1 and out5 would need to be entered in the I/O Table as an output. Otherwise, there will be a compilation error.

### 3.3.4 Example 2 – Toggle an Output

TOGGLEIO light 'This will change the output, light, from off to on or on to off

The output, light, would need to be entered into the I/O Table as an output as well and could represent any desired output.

### 3.3.5 Example 3 – Test the Status of an Output

This can be done using both the TESTBIT (*v, n*) and TESTIO (*labelname*) command.

Using TESTBIT (*v, n*)

X = TESTBIT (INPUT[2], 1) 'status of input #10 (on = 1, off = 0) is stored in variable X

Using TESTIO (*labelname*)

X = TESTIO (button) 'status of input button (defined in the I/O table) is stored in variable X



## Chapter 4 Timers, Counters & Sequencers

## 4 TIMERS, COUNTERS AND SEQUENCERS

### 4.1 Introduction

The Nano-10 PLC supports 64 timers with 0.1s or 0.01s time base, and 64 counters with range of 0 to 9999. You can define timer #1 to #n to become high speed timers (with 0.01s time base) by executing the "HSTIMER n" command (i.e. High Speed Timer always start from timer #1 up to timer #n).

#### 4.1.1 Timer Coils

A timer is a special kind of relay that, when its coil is energized, must wait for a fixed length of time before closing its contact. The waiting time is dependent on the "Set Value" (SV) of the timer. Once the delay time is up, the timer's N.O. contacts will be closed for as long as its coil remains energized. When the coil is de-energized (i.e. turned OFF), all the timer's N.O. contacts will be opened immediately. However, if the coil is de-energized before the delay time is up, the timer will be reset and its contact will never be closed. When the last aborted timer is re-energized, the delay timing will restart and use the SV of the timer rather than continue from the last aborted timing operation.

#### 4.1.2 Counter Coils

A counter is also a special kind of relay that has a programmable Set Value (SV). When a counter coil is energized for the first time after a reset, it will load the value of SV-1 into its count register. From there on, every time the counter coil is energized from OFF to ON, the counter decrements its count register value by 1. Note that the coil must go through an OFF to ON cycle in order to decrement the counter. If the coil remains energized all the time, the counter will not decrement. Hence, a counter is suitable for counting the number of cycles an operation has gone through. When the count register hits zero, all of the counter's N.O. contacts will be turned ON. These counter contacts will remain ON regardless of whether the counter's coil is energized or not. To turn OFF these contacts, you have to reset the counter using a special counter reset function [RSctr].

#### 4.1.3 Sequencers

A sequencer is a highly convenient feature for programming machines or processes that operate in fixed sequences. These machines operate in a fixed, clearly distinguishable step-by-step order, starting from an initial step, progressing to the final step, and then restarting from the initial step again. At any moment, there must be a "step counter" to keep track of the current step number. Every step of the sequence must be accessible and can be used to trigger some action, such as turning on a motor or solenoid valve, etc. As an example, a simple Pick-and-Place machine that can pick up a component from point 'A' to point 'B' may operate as follow:

Step #	Action
0	Wait for "Start" signal
1	Forward arm at point A
2	Close gripper
3	Retract arm at point A
4	Move arm to point B
5	Forward arm at point B
6	Open gripper
7	Retract arm at point B
8	Move arm to point A

## 4.2 Programming timers and counters on Ladder Logic

The timers and counters can be programmed in ladder logic in a few simple steps.

### 4.2.1 For Timers

1. Create/Edit the label names
2. Place the input contact(s) into the ladder logic circuit
3. Place the timer coil at the end of the ladder logic circuit
4. Place the timer contact in one or more ladder logic circuits

### 4.2.2 For Counters

1. Create/Edit the label names
2. Place the input contact(s) into the ladder logic circuit
3. Place the counter coil at the end of the ladder logic circuit
4. Place the counter contact in one or more ladder logic circuits (optional)

### 4.2.3 Example 1 – Creating a Simple Timer Circuit in Ladder Logic

You can place components in the circuit by clicking in the green area to the right of the red arrow, as shown in Figure 4.1 below. This will bring up the component tool bar in the gray area above the green circuit area.

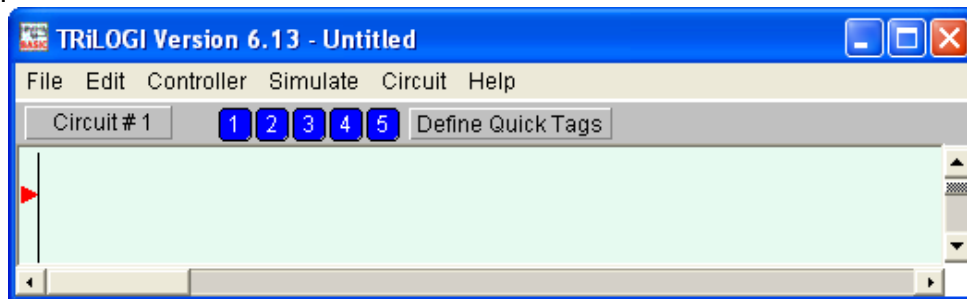



Figure 4.1: Creating Timer Circuit

Once the component toolbar is shown, you can place your activating contact by selecting the #1 component from the toolbar  and then selecting the activating contact from the I/O Table. The contact will then be automatically placed in the ladder logic circuit. The same can be done for the timer coil by selecting the #7 component from the toolbar  and then selecting a timer that has been entered into the I/O Table. Then a timer contact needs to be added as an input to a ladder logic circuit. This contact will activate once the timer counts down. This could be used to turn on an output a certain amount of time after the timer coil is activated. Placing a timer contact in a circuit is the same as placing any contact in a ladder circuit, except that the corresponding timer should be selected from the “Timers” section of the I/O table.

After creating a ladder circuit that contains one input and one timer output and another ladder circuit that contains one timer contact and one output, the ladder logic circuit should look something like Figure 4.2, below:

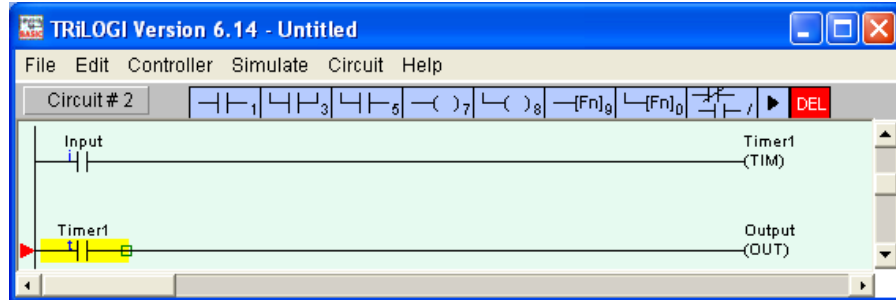

Figure 4.2: Completed Timer Circuit

#### 4.2.4 Example 2 – Creating a Simple Counter Circuit in Ladder Logic

You can place components in the circuit by clicking in the green area to the right of the red arrow, as shown in Figure 4.3 below. This will bring up the component tool bar in the gray area above the green circuit area.

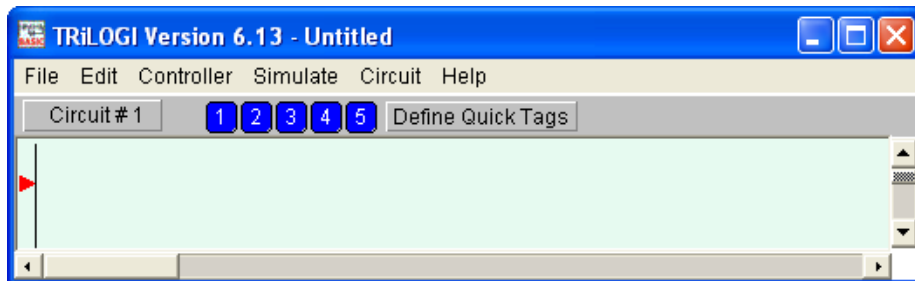



Figure 4.3: Creating Ladder Circuit

Once the component toolbar is shown, you can place your activating contact by selecting the #1 component from the toolbar  and then selecting the activating input from the I/O Table. The contact will then be automatically placed in the ladder logic circuit. The same can be done for the counter coil by selecting the #7 component from the toolbar  and then selecting a counter that has been entered into the I/O Table. Then a counter contact needs to be added as an input to a ladder logic circuit. This contact will activate once the counter counts down. This could be used to turn on an output after a certain count is reached. Placing a counter contact in a circuit is the same as placing any contact in a ladder circuit, except that the corresponding counter should be selected from the “Counters” section of the I/O table.

After creating a ladder circuit that contains one input and one counter output and another ladder circuit that contains one counter contact and one output, the ladder logic circuit should look something like Figure 4.4, below:

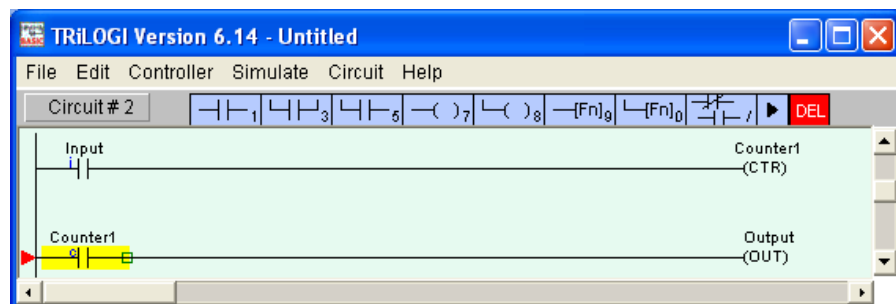

Figure 4.4: Completed Counter Circuit

## 4.3 Programming timers and counters in Custom Function

### 4.3.1 Programming Timers and Counters Present Values

The present values (PV) of the 64 timers and 64 counters in the PLC can be accessed directly as system variables:

timerPV[1] to timerPV[64], for timers' present value

ctrPV[1] to ctrPV[64], for counters' present value

### 4.3.2 Accessing Inputs, Outputs, Relays, Timers and Counters Contacts

The bit addressable I/Os elements are organized into 16-bit integer variables TIMERBIT[n] and CTRBIT[n] so that they may be easily accessed from within a CusFn. These I/Os are arranged as shown in the following diagram:

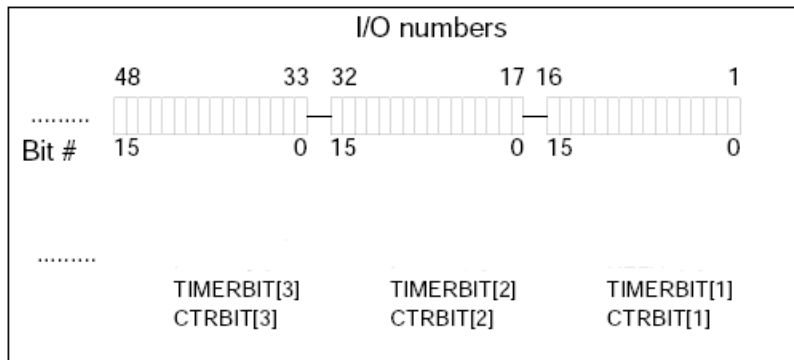

### 4.3.3 Changing The Timer and Counter Set Values in a Custom Function

You can use the SetTimerSV and SetCtrSV functions to change the Set Value (SV) for a timer and counter respectively. An example of this is shown below:

```
SetTimerSV 1,500  `Define Timer #1 to have a Set Value of 500
SetCtrSV 10,1000  `Define Counter #10 to have a Set Value of 1000
```

### 4.3.4 Volatility of Nano-10 Timer & Counter Set Values

It is important to know that, regardless of whether an FRAMRTC is installed, all the Set Values (SV) of timers and counters in Nano-10 PLC are stored at special pseudo EEPROM areas reserved for storing configuration data. We have described in detail how the pseudo EEPROM are implemented in the Nano-10 PLC (see [section 1.6.2](#)). Although this pseudo EEPROM area for storing configuration data is separate from the user-EEPROM area that you access with the SAVE\_EEP and LOAD\_EEP commands, the underlying mechanism works the same way.

That is to say, if your TBASIC program changes the SVs using the SetTimerSV and SetCtrSV command, the new SVs are only temporarily stored in the PLC RAM area until they are backup to the flash memory. As described in section 1.6.2, the backup process only occurs when the PLC is reset, rebooted or when

the SETSYSTEM 252, 0 command has been executed. Therefore, if you want the new SVs to be permanently stored in the PLC you will have to either run the SETSYSTEM 252, 0 command once, or perform a software reset to backup these new data to the flash memory so that the changes can become permanent.

### 4.3.5 Controlling a Timer or Counter in a Custom Function

You can activate a timer or a counter directly from within a custom function simply by assigning their present value counter to a desired value.

E.g. To start a 50 seconds timer:

```
TIMERPV[2] = 500 ` Timer #2 will time out 50.0 seconds later.
```

E.g. To decrement a counter or a sequencer:

```
CTRPV[10] = CTRPV[10] - 1 ` Counter #10 is decremented by 1.
```

---

## 4.4 Programming Sequencers on Ladder Logic

### 4.4.1 Introduction

TRiLOGI Version 6.xx supports eight sequencers of 32 steps each. Each sequencer uses one of the first eight counters (Counter #1 to Counter #8) as its step counter. Any one or all of the first eight counters can be used as sequencers "Seq1" to "Seq8".

To use a sequencer, first define the sequencer name in the Counter table by pressing the <F2> key and scroll to the Counter Table. Any counter to be used by the sequencer can only assume label names "Seq1" to "Seq8" corresponding to the counter numbers. For e.g. if Sequencer #5 is to be used, Counter #5 must be defined as "Seq5". Next, enter the last step number for the program sequence in the "Value" column of the table.

A circuit that uses the special function "Advance Sequencer" [AVSeq] will need to be constructed. The first time the execution condition for the [AVseq] function goes from OFF to ON, the designated sequencer will go from inactive to step 1. Subsequent changes of the sequencer's execution condition from OFF to ON will advance (increment) the sequencer by one step. This operation is actually identical to the [UPCtr] instruction.

The upper limit of the step counter is determined by the "Set Value" (SV) defined in the Counter table. When the SV is reached, the next advancement of sequencer will cause it to overflow to step 0. At this time, the sequencer's contact will turn ON until the next increment of the sequencer. This contact can be used to indicate that a program has completed one cycle and is ready for a new cycle.

Accessing individual steps of the sequencer is extremely simple when programming with TRiLOGI. Simply create a "contact" (NC or NO) in ladder edit mode. When the I/O window pops up for you to pick a label, scroll to the "Special Bits" table as follow:

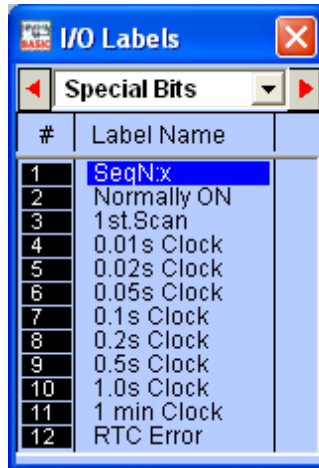

The "Special Bits" table is located after the "Counters" table and before the "Inputs" table. Click on the "SeqN:x" item to insert a sequencer bit. You will be prompted to select a sequencer from a pop-up menu. Choose the desired sequencer (1 to 8) and another dialog box will open up for you to enter the specific step number for this sequencer.

Each step of the sequencer can be programmed as a contact on the ladder diagram as "SeqN:X" where N = Sequencers # 1 to 8 and X = Steps # 0 - 31.

e.g. Seq2:4 = Step #4 of Sequencer 2.  
Seq5:25 = Step #25 of Sequencer 5.

Although a sequencer may go beyond Step 31, if you define a larger SV for it, only the first 32 steps can be used as contacts to the ladder logic. Hence it is necessary to limit the maximum step number to not more than 31.

Quite a few of the ladder logic special functions are related to the use of the sequencer. These are described below:

#### 4.4.2 Advance Sequencer - [AVseq]

Increment the sequencer's step counter by one until it overflows. This function is identical to (and hence interchangeable with) the [UpCtr] function.

#### 4.4.3 Resetting Sequencer - [RSseq]

The sequencer can also be reset to become inactive by the [RSseq] function at any time. Note that a sequencer that is inactive is not the same as sequencer at Step 0, as the former does not activate the SeqN:0 contact. To set the sequencer to step 0, use the [StepN] function described next.

#### 4.4.4 Setting Sequencer to Step N - [StepN]

In certain applications it may be more convenient to be able to set the sequencer to a known step asynchronously. This function will set the selected sequencer to step #N, regardless of its current step number or logic state. The ability to jump steps is a very powerful feature of the sequencers.

#### 4.4.5 Reversing a Sequencer

Although not available as a unique special function, a sequencer may be stepped backward (by decrementing its step-counter) using the [DNctr] command on the counter that has been defined as a sequencer. This is useful for creating a reversible sequencer or for replacing a reversible "drum" controller.

#### 4.4.6 Program Example

Assume that we wish to create a running light pattern which turns on the LED of Outputs 1 to 4 one at a time every second in the following order: LED1, LED2, LED3, LED4, LED4, LED3, LED2, LED1, all LED OFF and then restart the cycle again. This can be easily accomplished with the program shown in Figure 4.5.

The 1.0s clock pulse bit will advance (increment) Sequencer #2 by one step every second. Sequencer 2 should be defined with Set Value = 8. Each step of the sequencer is used as a normally open contact to turn on the desired LED for the step. A "Stop" input resets the sequencer asynchronously. When the sequencer counts to eight, it will become Step 0. Since none of the LEDs are turned ON by Step 0, all LEDs will be OFF.

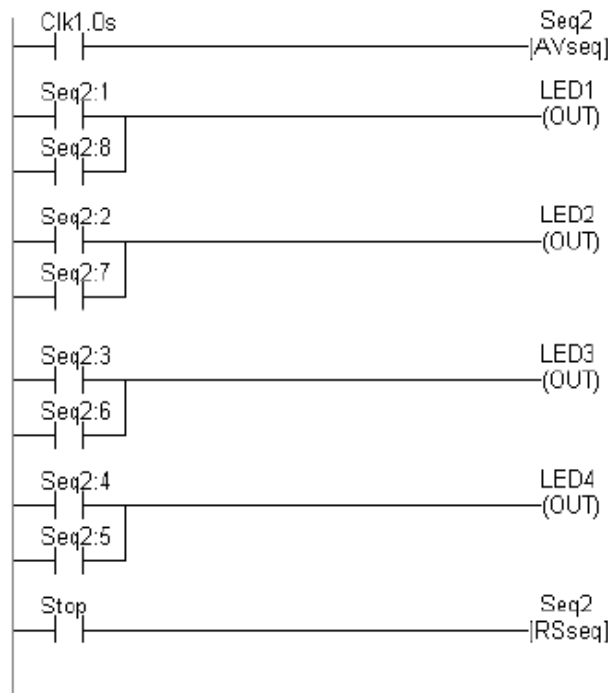

Figure 4.5

## 4.5 Programming Sequencers in Custom Function

You can change the current step of Sequencer easily from within a Custom Function by changing the present value of their equivalent counter. E.g. Sequencer #3 is the same as Counter #3, thus if you wish to assign Sequencer #3 to Step 10, you can achieve it as follows:

```
CTRPV[3] = 10
```



## Chapter 5 Analog Inputs

## 5 ANALOG INPUTS

### 5.1 Analog Power Supply

The analog power of the PLC is derived from the same 24VDC power supply as the CPU. It will generate a 5V regulated DC voltage source that will be used internally as voltage reference and is available externally for use by other analog input devices. The reference voltage output is available on the analog I/O connector terminal block, and may be used as the source voltage for connecting to potentiometers. Its current is limited to 30mA. Thus if you need more current for your analog device, you will need to supply your own +5V DC source.

### 5.2 Analog Inputs

Each Nano-10 has two channels of built-in 0-5V, 12-bit Analog inputs. The terminal block location for these analog inputs is described in [Section 1.2.1](#).

#### Electrical Characteristics

No. of A/D channel	2
Resolution	12-bit
Input Impedance Ch #1 to 2	20.00K Ohms
Moving Average	1 to 9 points (user definable)
Conversion Time	< 4 $\mu$ s per channel.

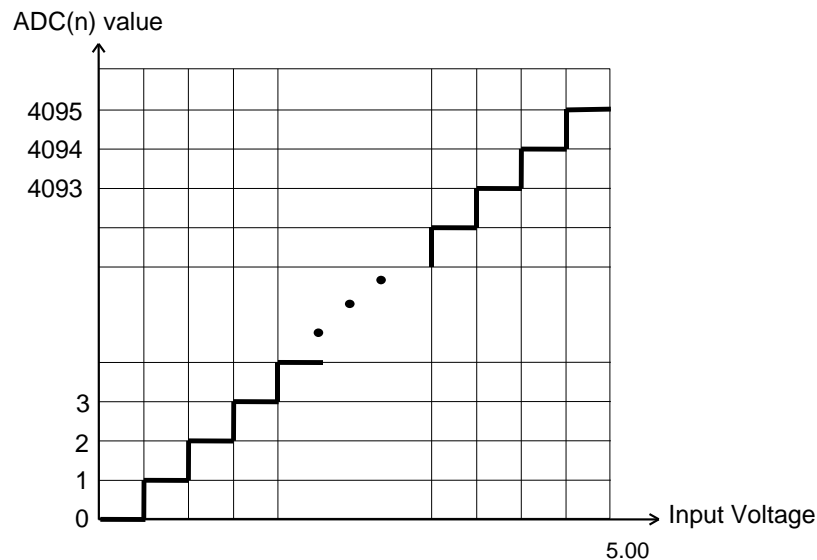

Figure 5.1 Transfer Function for 12-bit ADC.

The DC input impedance of Analog inputs #1 to 2 are all 20.00K ohms (0.1%). This is not a problem when connected to a 0-5V low impedance analog source.

However, if you need to connect to 0-10V inputs or a 4-20mA analog source to either channel, you have to take into consideration the low A/D input impedance in your design. The following figures show how to connect 4-20mA current source signals and 0-10V signals to the A/D inputs #1 to 2.

:

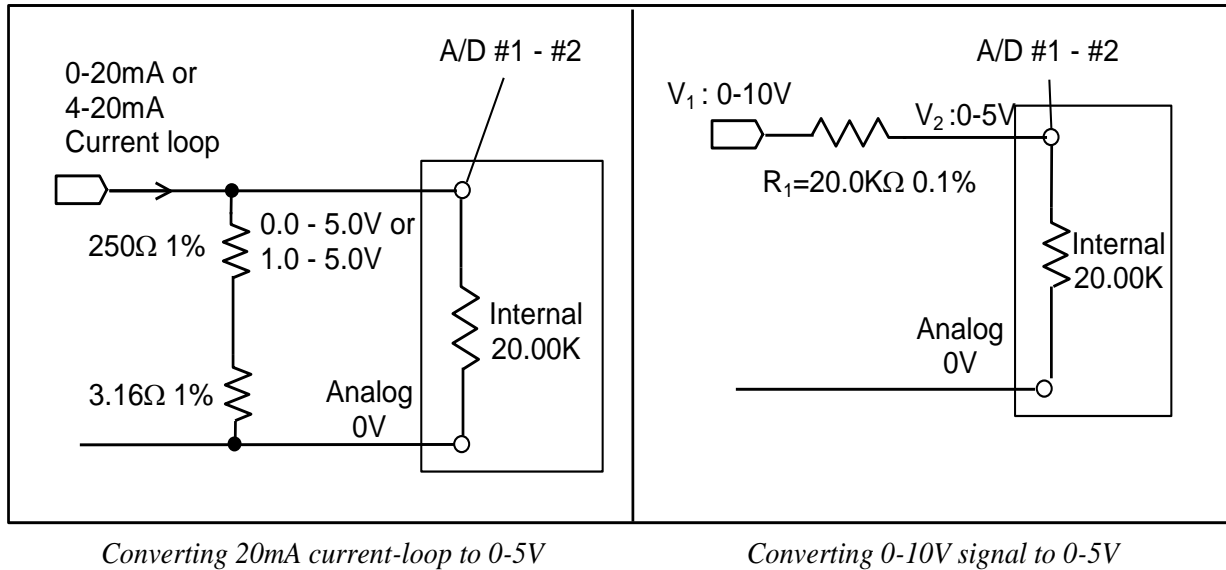

Figure 5.1

You can see that interfacing to a 0-10V analog signal is extremely simple since all you need is to add a 20.0K ohm series resistor and it will be divided into 0-5V when it enters the AD #1 or #2

However, to convert a 0-20mA or 4-20mA current source into 0-5V or 1-5V voltage signal, you should use a 253.16 ohm resistor which, when paralleled with the 20K ohm of internal impedance, will yield a 250.0 ohm total resistance. You can obtain 253.16 ohm by combining a 250 ohm and a 3.16 ohm metal-film resistor.

### 5.2.1 Interfacing to two-wire 4-20mA sensors

Many 4-20mA analog sensors only have two wire connections and are designed to be powered by the 4-20mA output current that flows through it. These types of sensors can be interfaced easily to the 0-5V analog inputs of the PLC as shown in the following diagram:

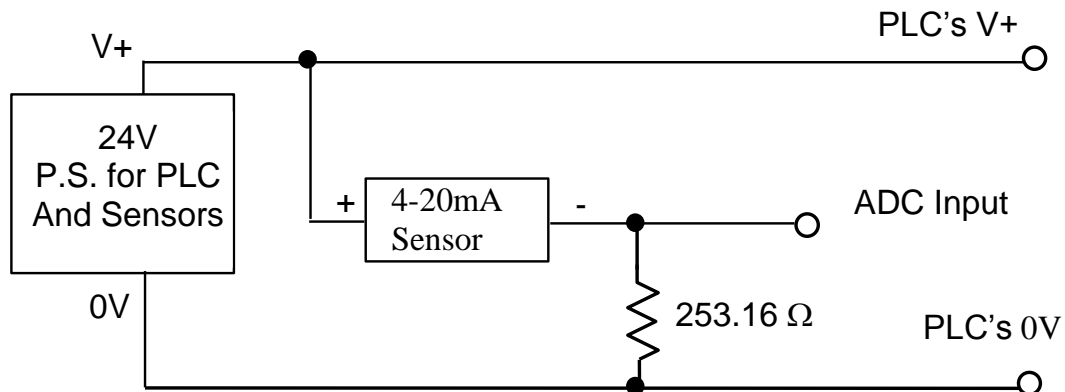

\* Use a 250.0 + 3.16 ohm resistors in series to obtain 253.16 ohm.

Again due to the 20.00K ohm internal resistance on the PLC's ADC inputs, you need to wire a 253.16 ohm resistor (formed by a 250 ohm and 3.16 ohm resistors in series) to the circuit in order to convert the 4-20mA signal to 1.00-5.00V analog voltage and can be read by the PLC using the ADC(n) statement, which will return readings of between 819 and 4095.

## 5.2.2 Using Potentiometer to Set Parameters

A potentiometer can provide a very low cost means for users to input parameters to the PLC such as temperature settings, timer or counter preset values, etc. The diagram above shows how easy it is to implement such a device using the 5V reference output and an analog input. Very accurate parameters can be set if an external LCD display (e.g. MDS100-BW) is used as visual feedback of the settings. Alternatively, a paper scale can be printed to give approximate set value at various angles of the potentiometer's rotating arm.

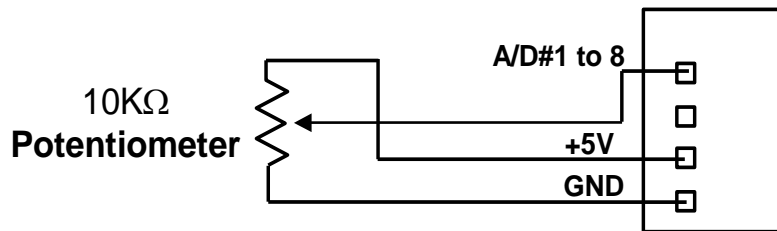

Figure 5.2

## 5.2.3 Reading Analog Input Data

The 2 analog input signals are read by the TBASIC command ADC(1) to ADC(2). The ADC(n) function will return a number between 0 and 4095 (12-bit resolution), which corresponds to the measured voltage at any of the analog inputs n. The resolution of a 12-bit ADC is  $1/4096$ , this means that for the 0-5V ADC range, the resolution is  $5/4096V = 1.22mV$ .

That means that if you apply a 2.500V to the PLC's analog input #3, ADC(3) should return a value of  $2.500/5.000 \times 4096 = 2048$ .

Note that the CPU only accesses the analog input #n when the TBASIC function ADC(n) is called. Hence, in order to monitor the analog input, you have to execute the ADC function periodically. The frequency that the ADC function is called is known as the "sampling rate" and it depends on how fast the analog data changes. If the analog data changes slowly (such as room temperature) then there may be no need to sample the analog at high frequency.

A very simple example of sampling the analog input #1 to #2 every second and converting the data into voltage readings of 0 to 5000 (which represents 0 to 5.000V) is shown as follow:

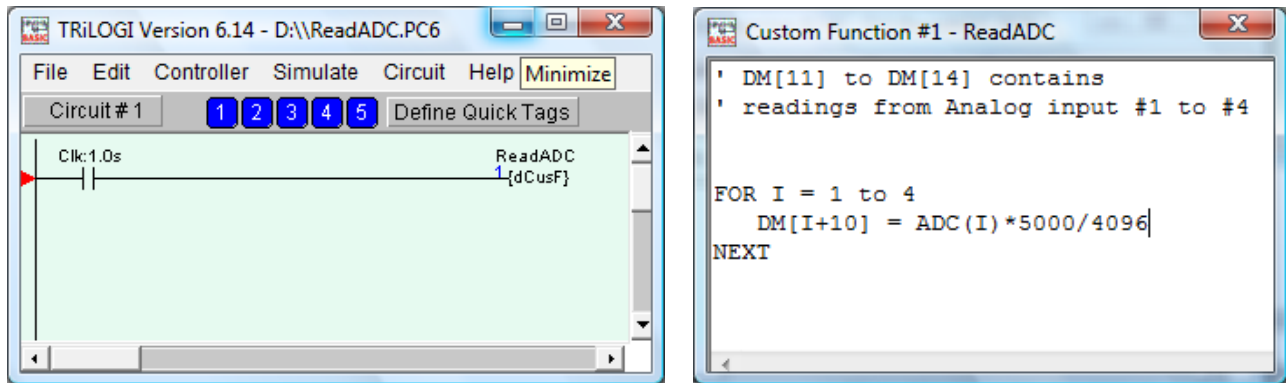

Figure 5.3

You can examine the readings of DM[11] to DM[12] from the “Online Monitoring - View Variables-DM[n]” screen. These readings represent the voltages measured at the analog input pins. You can also read the raw ADC readings (which will change in the range between 0 to 4095) from the “View Variables - integer” screen.

### 5.2.4 Moving Average

The Nano-10 PLC offers a built-in “Moving Average” computation routine for each ADC channel. When moving average is enabled the PLC firmware would store the past analog readings for each channel in its own historical memory array, and each new instantaneous reading would overwrite the oldest reading. When you run the ADC(n) function, the PLC firmware would return the average of these past readings instead of the instantaneous new reading.

You can define a moving average of 1 to 9 points using the procedure described in Section 5.4.3

Defining a larger moving average can better help to even out fluctuations in ADC readings that can be caused by interference from digital noise. However, the larger the moving average, the slower the ADC(n) function can detect a sudden change in the amplitude of the analog signal due to the averaging effect.

For a system that needs to quickly detect a signal change, consider using either a smaller number of moving average points or call the ADC(n) function more frequently so that a sudden change can be detected earlier.

### 5.2.5 Scaling of Analog Data

The 12-bit analog inputs on the Nano-10 PLC returns data in the range of 0 to 4095, which corresponds to the full range of the voltage input presented at the analog pin. However, very often a user needs a formula to translate this numeric data into units meaningful to the process (e.g. degree C or F, psi etc). To do so, you need to know at least two reference points of how the native unit maps to the PLC’s ADC reading.

Reference Point	ADC Reading
x1	a1
x2	a2

Hence, for any reading  $A = \text{ADC}(1)$ , the corresponding  $X$  is derived from:

$$\frac{X - x1}{x2 - x1} = \frac{A - a1}{a2 - a1} \implies X = (x2 - x1) * (A - a1) / (a2 - a1) + x1$$

Note that since  $x_1$ ,  $x_2$ ,  $a_1$ , and  $a_2$  are all constants the actual formula is much simpler than it appears above.

#### E.g. Temperature measurement

Temp	ADC(n)
30°	200
100°	3000

So for any ADC readings A, the temperature is:

$$X = 70*(A - 200)/2800 + 30$$

Note: To get better resolution, you can represent 30 degree as 300 and 100 degree as 1000 so if  $X = 123$  it means 12.3 degree.

## 5.3 Temperature Measurement Using Analog Inputs

### 5.3.1 Thermistor Temperature Sensors

A thermistor is a kind of resistor whose resistance decreases when its surrounding temperature increases. It is a very low cost and stable device that can be used to measure a wide range of ambient temperature from freezers to hot water boilers, which are commonly used in HVAC applications.

In order to convert the resistance changes into voltage readings to be read by the PLC's analog input, you can use it to form an arm of a voltage divider circuit which would present a variable voltage to the analog input when the temperature changes. A type of thermistor that measures 10.0K ohm at 25 degree C (simply called 10K thermistor) is especially suitable for use with the Nano-10 PLC because you can simply connect the 10K thermistor directly to the analog input due to its internal impedance of 20.00K ohm (0.1% accuracy).

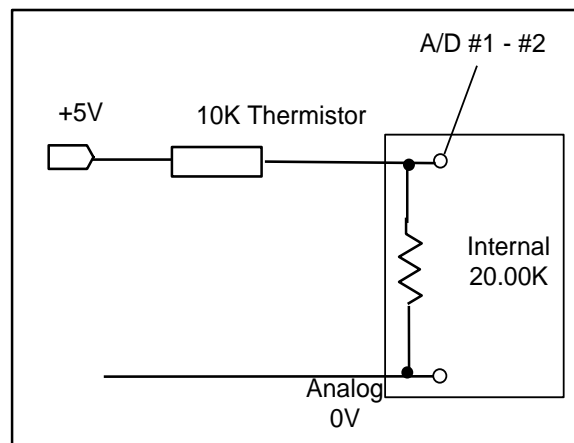

Figure 5.6: Connecting 10K Thermistor to NANO-10 ADC# 1-2

Note that since the thermistor resistance value vs. temperature change is a non-linear function, you cannot simply use a formula to calculate the temperature from the voltage value. For better accuracy you need to use a look up table plus a linear interpolation technique to determine the temperature based on the ADC readings. The look up table and interpolation method can be implemented using TBASIC quite

easily. For your convenience, we have provided a sample TBASIC program that you can download from the following URL:

<http://www.tri-plc.com/apnotes/Nano10/ThermistorSensor.zip>

This example uses the R-T (Resistance-Temperature) graph of the Precon Type III thermistor to implement the temperature look up. We have provided an Excel file that computes the ADC reading vs ambient temperature for this thermistor type. The TBASIC program uses these ADC readings to determine the temperature.

The sample program is structured such that the lookup table values are stored in DM area and you can readily adapt it to other types of thermistors with a different R-T graph. The program only implements lookup for a temperature range of  $-10^{\circ}\text{F}$  to  $110^{\circ}\text{F}$ , but you can also easily change the temperature range of interest.

### 5.3.2 Using LM34 Semiconductor Sensor

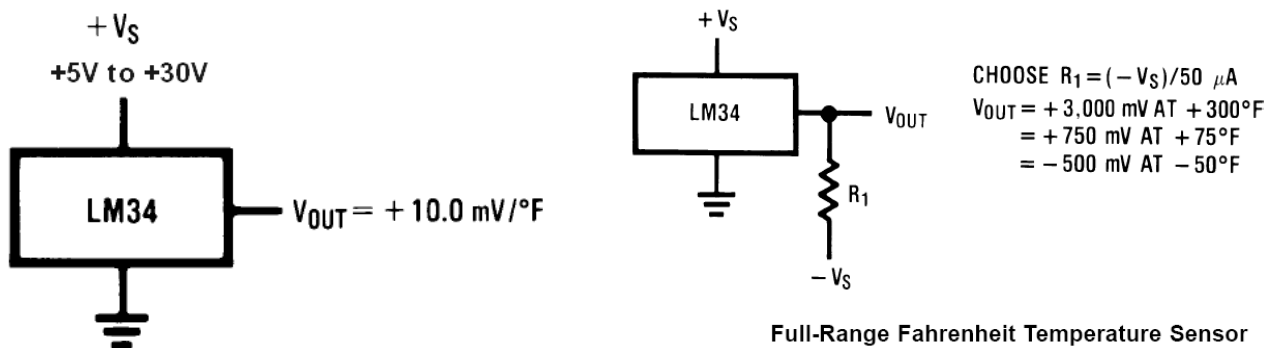

Figure 5.4

The LM34 is a wonderful, low cost semiconductor temperature sensor with a range of  $-50^{\circ}\text{F}$  to  $300^{\circ}\text{F}$ . It is extremely easy to use for measuring temperature above  $0^{\circ}\text{F}$ . You simply connect one pin to the positive voltage (+5 to +30V) and the other pin to 0V, and the signal pin will output a voltage that is directly proportional to the ambient temperature in  $^{\circ}\text{F}$ . The output voltage is 10mV per degree F.

So at room temperature of 72 degrees F, the device will output a voltage of  $72 \times 0.01 = 0.72\text{V}$ . If you connect this to the PLC's analog input, you can obtain the temperature in degree F or degree C using the formula:

$$\begin{aligned} F &= \text{ADC}(1) * 500 / 4096 && \text{in degree F} \\ \text{OR } C &= (F - 32) * 5 / 9 && \text{in degree C} \end{aligned}$$

Although another part number LM35 can output temperature in 10mV per degree C, the output falls into even lower ADC range for ambient temperature measurement since the same 72 degree F is only 22 degree C, which means LM35 only outputs  $22 \times 0.01 = 0.22\text{V}$ . Hence for better accuracy and resolution we recommend using LM34 instead of LM35 and if need be then convert it to degree C using TBASIC.

Another advantage for using LM34 instead of LM35 is that you can measure down to  $0^{\circ}\text{F}$  ( $-17^{\circ}\text{C}$ ) without using a negative voltage source as shown in the circuit on the right in Figure 5.5.

### 5.3.3 Using Thermocouple

Thermocouples are very rugged devices that are widely used in the industry because of their stability, accuracy, and wide functional temperature range. They are commonly used in measuring temperature in ovens that may go up to several hundred degrees C.

However, thermocouple output signals are in the range of tens of microvolts to mille-volts, which is too small to be measured by the Nano-10's analog input directly. You will need a "signal conditioner" that can amplify the thermocouple output to 0-5V, which can then be connected to the PLC's analog input.

### 5.3.4 Using PT100 Temperature Sensor

PT100 is a positive temperature coefficient thermistor that is made from platinum. It has the advantage of being very stable and highly accurate. It is usually connected to a signal conditioner in a balanced bridge configuration and the signal conditioner will convert temperature changes to 0-5V output for the PLC.

## 5.4 Calibration of ADC & Moving Average Definition

The ADC on the Nano-10 are factory-calibrated such that a voltage of 2.500V should return a value of 2048 when read by the ADC(n) function. However, if there is a need to re-calibrate the ADC you can follow the procedure outlined below.

To perform calibration of an ADC channel, you need to supply a precise DC voltage to the ADC channel, and then check the analog readings obtained via the ADC(n) function and compare it to the expected value. If there is an error, you can apply a correction factor to it.

To perform the ADC calibration, you would need to use the "Ethernet Configuration Tool" mentioned in Chapter 2.1. Click on the "Advanced" button on the Basic Configuration screen and open the "Advanced Configuration" screen. The bottom half of the screen contains ADC and DAC calibration constants that you can enter and transfer to the PLC, as shown below:

		Ch1	Ch2	Ch3	Ch4	Ch5	Ch6	Ch7	Ch8
<b>ADC Calib.</b>									
+0.000x	X =	-20	100	-25	60	50	50	30	60
Zero Offset	±	0	0	0	0	0	0	0	0
<b>DAC Calib.</b>									
±0.000x	X =	10	0	0	0				
Zero Offset	±	0	0	0	0				
							A/D Moving Avg		
							No. of pts (1-9)		3

Figure 5.6

### 5.4.1 ADC Calib.

These fields are used to apply a multiplication factor to the value returned by ADC function. The multiplication factor =  $(1 + x/10000)$ .

**Example 1:** If you apply 2.500V to ADC #1, you would expect the value returned by ADC(1) to be 2048. But the actual average reading centers around 2060.



Proportional Error =  $2060/2048 = 1.005859$   
 Multiplication factor required to correct this error =  $1/1.005859 = 0.9942 = (1 - 58/10000)$   
 $\Rightarrow x = -58$

You should therefore enter a value of 58 into the “ADC Calib” field for Ch #1 and save it to the PLC.

After the PLC has rebooted, the CPU would apply the multiplication factor of 0.9942 to the readings it received, which would correct the reading to:  $2060 \times 0.9942 = 2048$ .

**Example 2:** If you apply 4.000V to ADC #2, you would expect the ADC(2) function to return a value of  $4.000/5.000 \times 4096 = 3277$ . However, your program returned a value of 3230 from ADC(2).

Proportional Error =  $(3230)/3277 = 0.985658$   
 Multiplication factor required to correct this error =  $1/0.985658 = 1.0146 = (1 + 146/10000)$   
 $\Rightarrow x = +146$

To compensate for this error, enter a value of 146 in the “ADC Calib.” for Ch 2 and save it to the PLC.

After the PLC has rebooted, the CPU would apply the multiplication factor of 1.0146 to the readings it received, which would correct the reading to:  $3230 \times 1.0146 = 3277$ .

### Notes:

- 1) We have created an MS-Excel spreadsheet file “AnalogCalibration.xls” to facilitate the computations of the correction factor, X, used in the ADC and DAC Calibration of F-series PLC. The same file can also be used to compute the calibration factor for the Nano-10. This file can be downloaded from the following web page:

<http://www.tri-plc.com/appnotes/F-series/AnalogCalibration.xls>

- 2) Changes to the ADC calibration data only take effect after the PLC has been cold-booted. You can either power cycle the PLC or simply check the “Reboot PLC After Save” checkbox and the PLC will re-boot after you have transferred the parameters to it.

### 5.4.2 ADC Zero Offset

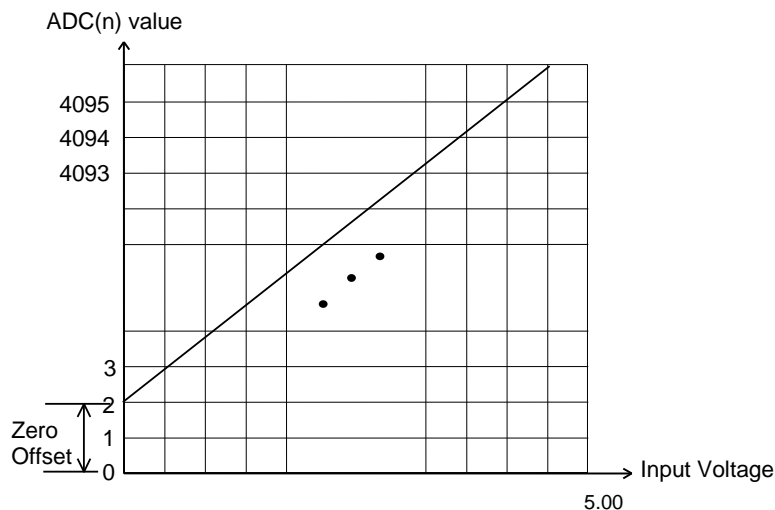

Figure 5.7

The zero offset error can be corrected by entering a value into the “ADC Zero Offset” field. Any number between –100 and 100 can be entered here. The ADC(n) function would add the zero-offset value that you entered here to the measured value and return the total sum to the calling routine.

### 5.4.3 A/D Moving Avg

This field lets you define the number of points of moving average that the Nano-10 CPU firmware uses to compute the value returned by the ADC(n) function (Please see explanation of moving average in Section 5.2.5).

A larger number of moving Average points has the positive effect of filtering out large noise spikes seen at the analog input, but the disadvantage is that the PLC would be slower in noticing a sudden step change at the analog input. If you specify a moving average of 1 point, that means no moving average will be used and the ADC(n) function will return the most recently sampled data at the analog input #n.

## Chapter 6 Special Digital I/Os

## 6 SPECIAL DIGITAL I/Os

All of the 4 digital inputs of the Nano-10 PLC can be configured as “special inputs” such as High Speed Counters, Interrupts and Pulse Measurement. 2 of the 4 digital outputs can also be configured as PWM, or stepper motor controller pulse-outputs. If these are not used as special I/Os, then they can be used as ordinary ON/OFF type I/O in the ladder diagram. The High Speed Counters and Pulse measurement inputs share physical inputs, but they can be used simultaneously as HSC and PMON (unlike M-Series). Note that if any other two special functions share the same I/O then only one of them can be active at any one time. The location of these special I/Os are tabulated as follows:

### Special Inputs

Input #	High Speed Counter	Interrupt	Pulse Measurement
1	Ch #1: Phase A	Ch #1	Ch #1
2	Ch #1: Phase B	Ch #2	Ch #2
3	Ch #2: Phase A	Ch #3	Ch #3
4	Ch #2: Phase B	Ch #4	Ch #4

**Note:** While inputs 1-4 can be used simultaneously as High Speed Counters **and** Pulse Measurement pins, any pins defined as interrupts can only be interrupts.

### Special Outputs

Output #	Stepper Pulse/Dir outputs	PWM output
1	Ch #1 Direction	Ch #1
2	Ch #1 Pulse	Ch #2
3	-	-
4	-	-

These special I/Os therefore share the same electrical specifications as the ON/OFF type I/Os, which have already been described in the Chapter 1 - Installation Guide. We will describe each of these special I/Os in greater details in the following chapters.

## Chapter 7 High Speed Counters

## 7 HIGH SPEED COUNTERS

### Technical Specifications:

No. of Channels	2
Maximum acceptable pulse rate	10KHz per channel
Quadrature signal decoding	Automatic
Relevant TBASIC Commands	HSCDEF, HSCOFF, HSCPV[ ]

### 7.1 Introduction

Digital inputs #1 + 2, #3 + 4, form two channels of high speed counter inputs which can interface directly to a rotary encoder that produces “quadrature” outputs. A quadrature encoder produces two pulse trains at a 90° phase shift from each other as follows:

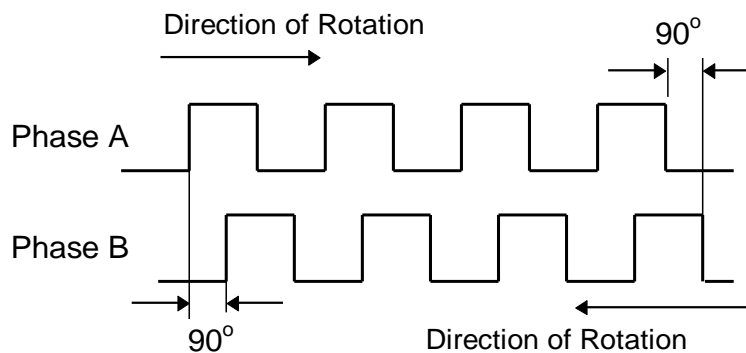

Figure 7.1

When the encoder shaft rotates in one direction, phase A leads phase B by 90 degrees. When the shaft rotates in the opposite direction, phase B will lead phase A by 90 degrees. The quadrature signals therefore provide an indication of the direction of rotation.

The F-Series PLC handles the quadrature signals as follows: if the pulse train arriving at input #1 leads the pulse train at input #2, the High Speed Counter (HSC) #1 increments on every pulse. If the pulse train arriving at input #1 lags the pulse trains at input #2, then the HSC #1 decrements. Note that if input #2 is OFF, then pulse trains arriving at input #1 are considered to lead the input #2 and HSC #1 will be incremented. Likewise if input #1 is OFF, then pulse trains arriving at input #2 will decrement HSC #1.

Inputs #3 and #4 form the inputs for High Speed Counter channel #2, which operates in the same way as HSC#1 described above.

The fact that the Nano-10 PLC automatically takes care of the direction of rotation of the quadrature encoder greatly simplifies the programmer’s task of handling high-speed encoder feedback. The HSCDEF statement can be used to define a CusFn to be executed when the HSC reaches a certain pre-defined value. Within this CusFn you can define the actions to be taken and define the next CusFn to be executed when the HSC reaches another value. Please note that the HSDDEF statement will also activate the Pulse Measurement hardware as described in the Pulse Measurement section.

A programming example of the HSC can be found in your iTRiLOGI program folder:

C:\TRiLOGI\TL6\usr\samples\HighSpeedCtr.PC6

## 7.2 Enhanced Quadrature Decoding

The default method in which the PLC handles quadrature signals as described above is somewhat simplistic. It does not take into consideration the “jiggling” effect that occurs when the encoder is positioned at the transition edge of a phase. Mechanical vibration could cause multiple counts if the rotor shaft “jiggles” at the transition edge of the phase, resulting in multiple triggering of the counter. This simplistic implementation, however, does have the advantage that the HSC can also be used for single-phase high-speed counting.

For the Nano-10 PLC, an enhanced quadrature decoding routine is provided which will lock out multiple counting by examining the co-relationship between the two phases. You can configure the Nano-10 PLC to use the enhanced quadrature counting by using the SETSYSTEM command, as follows:

```
SETSYSTEM 4, n
```

The value of n at bit 0, 1, and 2 respectively defines if the HSC channel 1, 2, and 3 is to run in “Simple” (when the bit is 0) or “Enhanced” (when the bit is 1) mode. As such:

N (bit 1,0)	HSC #2	HSC #1
0 (00)	Simple	Simple
1 (01)	Simple	Enhanced
2 (10)	Enhanced	Simple
3 (11)	Enhanced	Enhanced

## 7.3 Configuring HSC as x1, x2 or x4 Counters

By default the HSC in Nano-10 only increment or decrement the counter by 1 for each full cycle of pulses.

However, since there are two pulse trains and therefore a full cycle produces 4 rising and falling edges in total. It is possible to configure the HSC to either count by 1 for every two transition edges (x2) or to count every transition edge (x4).

A new, special **SETSYSTEM 24 ,N** command can be used to configure the 2 channels of HSCs on the Nano-10 PLC so that they can become simple, x1, x2 or x4 quadrature high speed counters. This new command (not available to T100M+ PLCs) overwrites the settings performed by SETSYSTEM 4, xx mentioned in Section 7.2 and is the new, preferred method for configuring the HSC channel.

*N* is defined as a two-byte integer:  
 Upper byte : channel number (&H01 or &H02)  
 Lower byte : &H00 =simple; &H01=x1; &H02=x2; &H03= x4

E.g. To define HSC #1 as x2 HSC, N = &H0102  
 To define HSC #2 as x4 HSC, N = &H0203

An example program: “HSC-x4.PC6” that uses this command is included in the “Nano10Samples.zip” file that you can download from: <http://www.tri-plc.com/trilogi/Nano10Samples.zip>.

## 7.4 Interfacing to 5V type Quadrature Encoder

If you have a choice, you should select an encoder that can produce 12V or 24V output pulses so that they can drive the inputs #1,2,3,4 directly. If you have a 5V type of encoder only, then you need to add a transistor driver to interface to the PLC's inputs. The simplest way is to use an IC driver ULN2003 connected as shown in Figure 7.2.

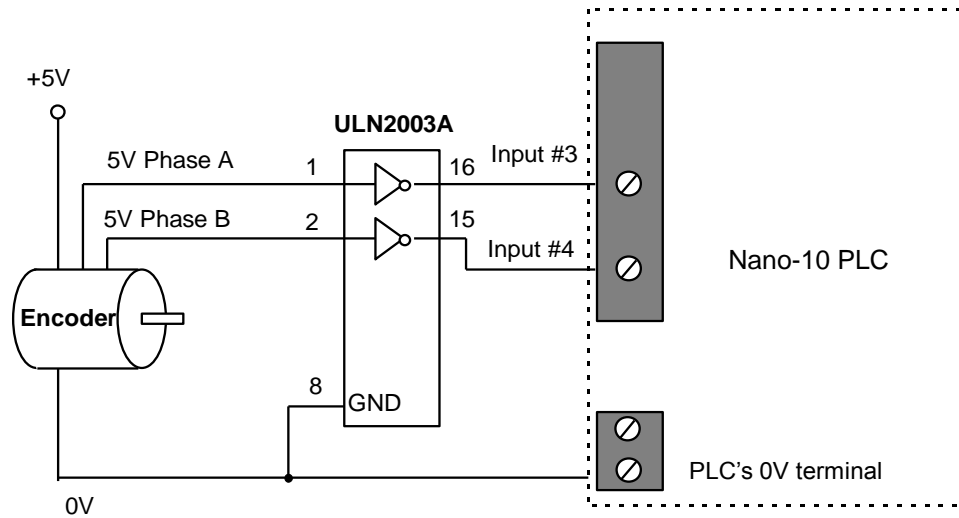

Figure 7.2 Interfacing 5V type Rotary Encoder



## Chapter 8 Frequency / Speed Measurement

## 8 FREQUENCY / SPEED MEASUREMENT

The Nano-10 PLC provides a very straightforward means to measure the pulse width (of the ON cycle), the frequency, or the period of a rectangular-wave pulse-train arriving at its Pulse Measurement (**PM**) inputs #1,2,3,4. (Which are mapped to digital inputs #1 to #4 – see Chapter 6).

### 8.1 Programming of PM Input

- 1) To use the PM input to measure pulse width or frequency, execute the PMON statement ONCE to configure the relevant input to become a pulse measurement input. You usually put the PMON statement in the init custom function and execute it with a “1st.Scan” pulse.
- 2) Thereafter the pulse width (in  $\mu\text{s}$ ) or the pulse frequency (in Hz) can be easily obtained from the PULSEWIDTH(n) or PULSEFREQUENCY(n) functions. You can also obtain the pulse period (inverse of frequency) using the PULSEPERIOD function.

E.g.   A = PULSEWIDTH(1)  
           B = PULSEPERIOD(1)  
           C = PULSEFREQUENCY(1)

- 3) All PM inputs by default return the measured pulse width and pulse period in unit of microsecond. However, for those who desire better resolution, you can define PM #1 to #4 to return the measured pulse width and pulse period in 0.1 microsecond resolution by executing the following command once only during initialization:

```
SETSYSTEM 20, 1
```

Once the above statement is executed, if PUSLEWIDTH(1) - PULSEWIDTH(4) returns the value 1234 it means the measured pulse width is 123.4  $\mu\text{s}$ .

A sample program can also be found on your i-TRiLOGI installation folder at:

```
C:\TRiLOGI\TL6\usr\samples\PulseMeasurement.PC6
```

## 8.2 Applications

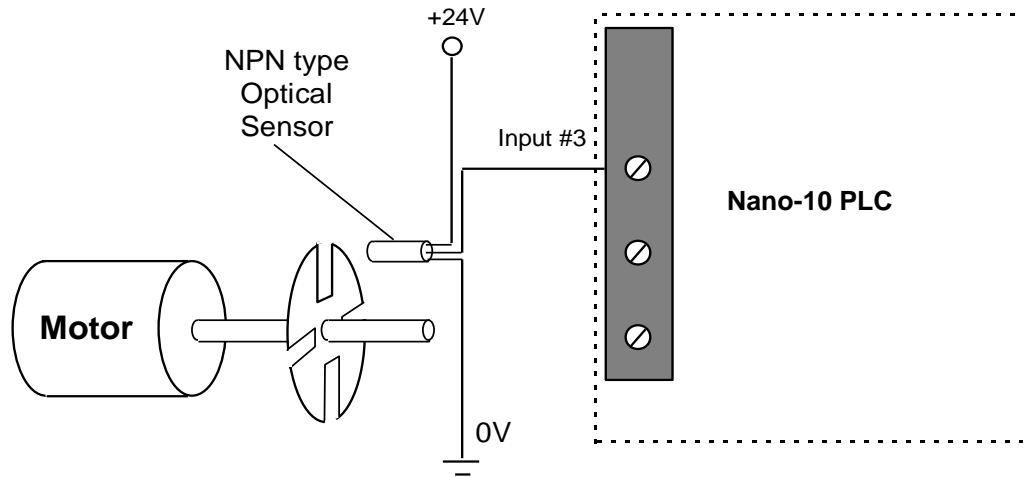

Figure 8.1 Setting Up a Simple Tachometer or Encoder

### 8.2.1 Measuring RPM Of A Motor

One useful application of the PM capability is to measure the speed of rotation (RPM) of a motor. A simple optical sensor, coupled with a rotating disk with slots fitted to the shaft of a motor (See Figure 8.1) can be fabricated economically. When the motor turns, the sensor will generate a series of pulses. The frequency of this pulse train directly measures the rotational speed of the motor ( $\text{RPM} = \text{Frequency} \times 60$ ) and can be used to provide precise speed control.

Note that the above setup can also double as a low cost position-feedback encoder when used with the high speed counter, since the number of pulses counted can be used to determine the displacement. With the Nano-10 PLC, the pulses can be both counted and measured **simultaneously** on the same input.

### 8.2.2 Measuring Transducer with VCO Outputs

Some transducers incorporate a Voltage-Controlled-Oscillator (VCO) type of output that represents the measured quantities in terms of varying frequency of the output waveform. Such transducers may be used conveniently by the Nano-10 PLCs using the pulse measurement capability. However, the frequency of such signals should be below the maximum input pulse rate.

### 8.2.3 Measuring Transducer with PWM Outputs

Some transducers may output the readings of their measurands (the quantity that is being measured) in the form of “pulse-width modulated” outputs. This means that the transducer would send rectangular pulses with varying duty cycles that are proportional to the measured quantities. You can then easily use the PULSEWIDTH and PULSEPERIOD functions to compute the duty cycle of the incoming PWM pulses and readily convert it to the actual units of the measurands. The Nano-10 PLC should be able to measure with reasonable accuracy the pulse width of incoming pulses not exceeding 10KHz.

## 8.3 Frequency Measurement on High Speed Counter Inputs

For applications that require frequency measurement and pulse counting of the same signal, you only need to feed the pulse input into any pair of the inputs #1 & 2, or inputs #3 & 4, or inputs #5 & 6 and define it as a High Speed Counter (see Chapter 7). This is because an input pin that has been defined as an HSC will automatically be enabled for pulse measurement.

In other words, if you need to use the HSC and the Pulse Measurement on the same channel, then you don't execute both the HSCDEF and PMON, you only need to execute the HSCDEF. The HSCDEF function will automatically start the Pulse Measurement hardware so it is not necessary to use the PMON statement. If you use only the PMON statement, it would not enable the HSC function. However, if you execute the HSCDEF statement and followed by the PMON statement, the HSC will be disabled, even though it was previously enabled.

## Chapter 9 Interrupts

## 9 INTERRUPTS

### 9.1 Input Interrupts

During normal PLC ladder program execution, the CPU scans the entire ladder program starting from the first element, progressively solving the logic equation at each circuit until it reaches the last element. After which it will update the physical Inputs and Outputs (I/O) at the end of the scan. Hence, the location of a logic element within the ladder diagram is important because of this sequential nature of the program execution.

When scanning the ladder program, the CPU uses some internal memory variables to represent the logic states of the inputs obtained during the last I/O refresh cycle. Likewise, any changes to the logic state of the outputs are temporarily stored in the output memory variable (not the actual output pin) and will only be updated to the physical output during the next I/O refresh.

You can see that the CPU will only notice any change to the input logic state when it has completed the current scan and starts to refresh its input variables. The input logic state must also persist for at least one scan time to be recognized by the CPU. In some situations this may not be desirable because any response to the event will take at least one scan time or more.

An interrupt input, on the other hand, may occur randomly and the CPU will have to suspend whatever it is doing as soon as it can and start “servicing” the interrupt. Hence, the CPU responds much faster to an interrupt input. In addition, interrupts are “edge-triggered”, meaning that the interrupt condition occurs when the input either changes from ON to OFF or from OFF to ON. Consequently, the input logic state need not persist for longer than the logic scan time for it to be recognized by the CPU.

Any one or all of the Nano-10's digital inputs #1 to #4 can be defined as interrupt inputs using the INTRDEF statement. The Interrupt inputs may also be defined as either rising-edge triggered (input goes from OFF to ON) or falling-edge triggered (input goes from ON to OFF), or both using the following statement:

```
INTRDEF ch, fn_num, edge
```

parameters:

*ch* = channel number

*fn\_num* = Custom Function # to execute when interrupt edge occurred.  
This is the Interrupt Service Routine (ISR)

*edge* = +1 :rising edge-triggered,  
-1 :falling edge-triggered  
0 : both rising and falling edge-triggered.

When the defined edges occur, the defined CusFn will be immediately executed irrespective of the current state of execution of the ladder program.

A simple interrupt test function is as follow:

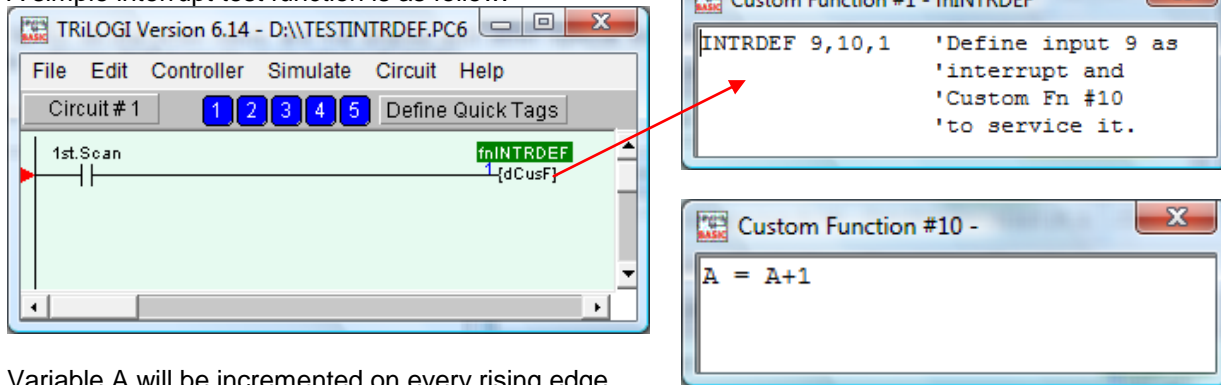

Variable A will be incremented on every rising edge sensed on Input #9 (not available on Nano but available on F-series PLCs).

### Note:

- 1) Since inputs 1 to 4 can also be used as other special inputs such as High Speed Counter (HSC) inputs and/or Pulse Measurement (PM) as described in Chapter 6, 7 and 8, if these inputs are defined as interrupts using the INTRDEF statement, then they will lose their other special function. i.e., they can only be defined either as a HSC/PM or as an interrupt input and not both.
- 2) When the digital inputs are used as interrupt inputs, the PLC operating system does not perform software filtering on these inputs. That means these interrupt inputs are extremely sensitive and will trigger the interrupt service routine even with the shortest input pulse.

While the high sensitivity could be useful for some applications that need to capture events that produce very short, sharp pulses, it could be problematic for other applications that need to filter out such narrow pulses since they can trigger the interrupt inputs multiple times. You can add in some hardware filtering by connecting a small, 100pF (or large capacitor) across the interrupt input and the power supply ground (0V).

## 9.2 Periodic Timer Interrupt (PTI)

The Periodic Timer Interrupt (PTI - not available on T100M+ PLC) lets you define a custom function that will be executed by the CPU precisely every  $x$  number of milliseconds (ms). The syntax for setting up a PTI is as follow:

```
INTRDEF 18, cfnum, x ' Interrupt 18 is reserved for PTI
```

*cfnum* - custom function number to execute when PTI event takes place.

*x* - The period in number of milliseconds between two PTI events.

E.g. INTRDEF 18, 101, 15 ' call function #101 every 15 ms.

The Periodic Timer Interrupt runs independently of the ladder logic and its execution is therefore not affected by the total PLC program scan time.

When the PTI timer times up, the CPU will suspend the execution of the ladder logic or a (non-interrupt) TBASIC function and immediately calls up the custom function defined by the INTRDEF 18 statement. However, if the CPU is currently executing a user-interrupt service routine (e.g. an input interrupt or HSC interrupt), then the CPU will have to complete the current interrupt service routine before it will run the PTI interrupt function.

**Notes:**

- 1) Limit the use of PTI only for critical code that requires precise timing between two events. Program bugs that occur due to problems in the PTI interrupt routine may be quite hard to debug.
- 2) For normal periodic routines, such as checking for temperature or checking serial port for incoming bar code data every few seconds, it is better to use the system clock pulses e.g. "Clk:1.0s" to trigger a {dCusF}.
- 3) Always try to keep your interrupt service routine short and simple and ensure that it will not end up in an endless loop. The TBASIC custom function execution time should be much shorter than the period of the PTI events. Otherwise, you may find that the CPU will be spending most of its time servicing the PTI interrupt routine, leaving very little time for scanning the ladder program, and that will have an adverse impact on the CPU performance.

### 9.3 Power Failure Interrupt (PFI)

The Nano-10 CPU has a built-in power failure sensing circuit that will call a custom function when it detects an impending power failure. This allows you to perform such critical function such as saving critical data to the PLC's non-volatile memory (see [Section 1.6.2](#)) just before power failure.

The syntax for the PFI is as follow:

```
INTRDEF 17, cfnum, 1 ' Interrupt 17 is reserved for PFI
```

*cfnum* - custom function number to execute when PTI event takes place.

E.g. INTRDEF 17, 256, 1 ' call function #256 when power failure occur.



## Chapter 10 Stepper Motor Control

## 10 STEPPER MOTOR CONTROL

### 10.1 Technical Specifications:

No. of Channels (control signal)	1
Max. Pulse Rate (pps)	10000
Continuous Current per phase	2A @24V DC
Driver Breakdown Voltage	+55V
Velocity Profile (Defined by STEPSPEED)	Trapezoidal -accelerate from 1/8 max pps to max pps. -decelerate from max pps to 1/8 max pps)
Maximum number of steps	$2 \sim 2^{31}$ ( $= 2.1 \times 10^9$ )
TBASIC commands	STEPSPEED, STEPMOVEABS, STEPCOUNTABS( ), STEPMOVE, STEPSTOP, STEPCOUNT( )

It is essential to understand the difference between a stepper motor “Controller” and a stepper motor “Driver”. A stepper motor “Driver” comprises the power electronics circuitry that provides the voltage, current, and phase rotation to the stepper motor coils. A stepper motor controller, on the other hand, only supply the direction and output a number of pulses to an external stepper motor driver to actually drive the stepper motor.

Since the Nano-10 PLC only has two high speed digital outputs, the PLC is only capable of acting as stepper motor controller to supply the direction and pulse control signals to an external stepper motor driver.

### 10.2 Nano-10 As Stepper Motor Controller

When configured as a Stepper-Motor Controller, the PLC would generate the required number of "pulses" and sets the direction signal according to the defined acceleration and maximum pulsing rate specified by "STEPSPEED" and "STEPMOVE" commands. The "pulse" and "direction" outputs are not meant to be connected directly to the stepper motor. Instead, you will need a stepper motor "driver", which you can buy from the motor vendor. Depending on the power output, the number of phases of the stepper motor, and whether you need micro-stepping, the driver can vary in size and cost. Most stepper motor drivers have opto-isolated inputs which accept a direction signal and stepping-pulse signal from the "Stepper Motor Controller". In this case the F-Series PLC is the "Stepper Motor Controller" which will supply the required pulse and direction-select signals to the driver.

Note that the digital output #1 automatically becomes the direction-select signals for the Stepper controller channels #1 and digital output #2 automatically becomes the pulse signal output when the stepper controller is being used. The direction pin is turned ON when the motor moves in the negative direction and turned OFF when the stepper motor moves in the positive direction. The STEPMOVEABS command makes it extremely simple to position the motor at an absolute location, while the STEPMOVE command lets you implement incremental moves in either direction for each channel.

### 10.2.1 Interfacing to 5V Stepper Motor Driver Inputs

Some stepper motor drivers accept only 5V signals from the stepper motor controller. In such a case, you need to determine whether the driver's inputs are opto-isolated. If they are, then you can simply connect a 2.2K current limiting resistor in series with the path from the PLC's output to the driver's inputs, as shown in Figure 10.1.

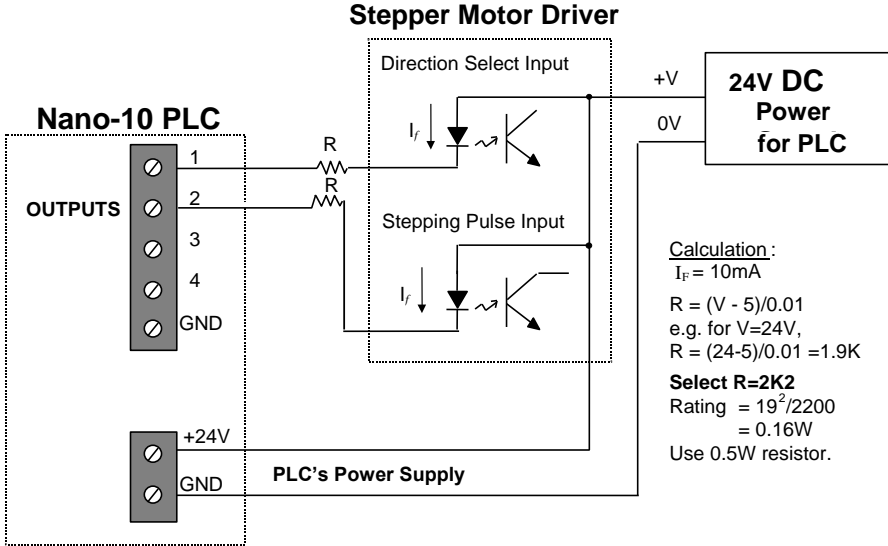

Figure 10.1

However, if the stepper motor driver input is only 5V CMOS level and non opto-isolated, then you need to convert the 24V NPN PLC outputs to 5V. This can be achieved using a low cost transistor such as a 2N4403. A better way is to use an opto-isolator with a logic level output, as shown in Figure 10.2. This provides a galvanic isolation between the PLC and the stepper motor driver.

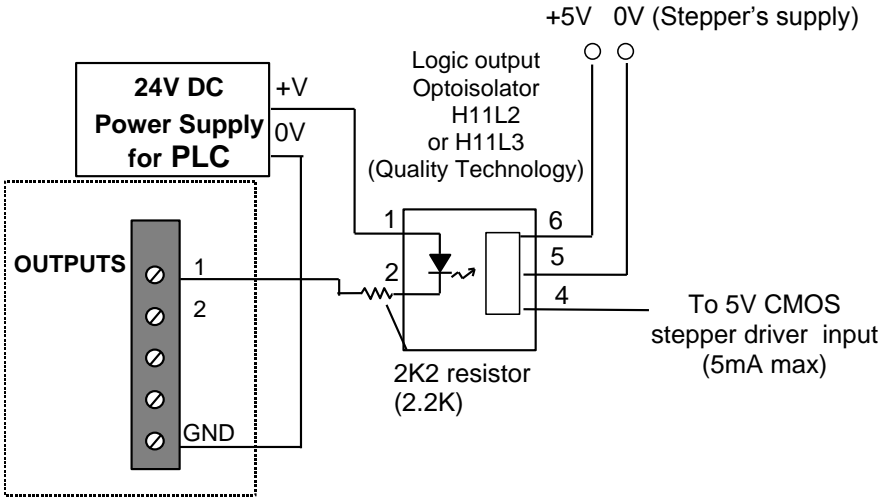

Figure 10.2 Conversion of Nano-10 outputs to 5V logic level

## 10.3 Programming Stepper Control Channel

### 10.3.1 Introduction

The PLC's stepper motor controller channel #1 is controlled by the PLC program using the "STEPMOVE" and "STEPMOVEABS" commands. These commands have the same parameters as they did when they were used on M-Series PLCs. For example,

```
STEPMOVE  ch, count, r
STEPMOVEABS  ch, position, r
```

The *ch* parameter is the channel. This is how the PLC knows which stepper motor channel to turn on. Now this parameter is also used to set the stepper motor channel to controller mode, full-step driver mode, or half-step driver mode.

To set the stepper motor channel to controller mode, the *ch* parameter should be a "1".

The same format should be used for STEPMOVEABS, except that the count parameter is changed to the position parameter (more details provided in the Programmers Reference manual and also in the program examples section of this chapter).

### 10.3.2 Setting the Acceleration Properties

Before the stepper motor channel can be used to control a stepper motor driver, the STEPSPEED command must be executed first in order to define the acceleration settings. Once this command has been executed, the acceleration settings will not change until another STEPSPEED command is executed with different settings or if the PLC is powered down. If the PLC is powered down, the STEPSPEED command will need to be executed again before the stepper motor channels can be used. However, if a software reset executed (from online monitoring or within the program), the STEPSPEED command does not need to be re-executed.

```
STEPSPEED  ch, pps, acc
```

The *ch* parameter should be a 1. Speed, *pps*, is based on the no. of pulses per second (*pps*) output by the pulse generator. The *pps* parameter should be set to a value between 1 and 10000 (max rated *pps* for the Nano-10 PLC). The acceleration, *acc*, determines the total number of steps taken to reach full speed from a standstill and the number of steps from full speed to a complete stop. The stepper motor controller calculates and performs the speed trajectory according to these parameters when the STEPMOVE or STEPMOVEABS commands are executed.

To set stepper motor channel #1 to a speed of 100 pps in 50 steps, the command would be as follows:

```
STEPSPEED 1, 100, 50
```

This would be equivalent to an acceleration of 100 pulses/s<sup>2</sup>, which can be calculated using the following expression:

$$A = V^2/2S = 100^2/2*50 = 100\text{pps}^2$$

### 10.3.3 Using the STEPMOVE Command

Once the STEPSPEED command is executed, the STEPMOVE command can be used to move the stepper motor forwards or backwards.

```
STEPMOVE ch, count, r
```

The *ch* parameter specifies which stepper motor channel is being used and should be '1' on Nano-10 PLC.

The *count* parameter specifies how many pulses the motor will move. If the motor were in half-step driver mode, then count would be in half steps.

The *r* parameter specifies which internal relay will be activated once the motor has moved *count* number of steps. This relay would be cleared when the STEPMOVE command is executed in case it was already activated.

#### Example 1: Moving Forwards

```
STEPMOVE 1, 500, 101 \ channel 1 would send 500 pulses
                   \ to a driver and then turn on relay 101
```

#### Example 2: Moving Backwards

```
STEPMOVE 1, -500, 101 \ channel 1 would send 500 pulses
                     \ to a driver and then turn on relay 101
```

### 10.3.4 Using the STEPMOVEABS Command

This command allows you to move the stepper motor # *ch* to an absolute position indicated by the position parameter. At the end of the move the relay # *r* will be turned ON. Position can be between  $-2^{31}$  to  $+2^{31}$  (i.e. about  $\pm 2 \times 10^9$ ). The absolute position is calculated with respect to the last move from the "HOME" position. (The HOME position is set when the STEPHOME command is executed). The speed and acceleration profile are determined by the STEPSPEED command as in the original command set.

This command automatically computes the number of pulses and the direction required to move the stepper motor to the new position with respect to the current location. The current location can be determined at any time by the STEPCOUNTABS () function.

Once the STEPMOVEABS command is executed, re-execution of this command or the STEPMOVE command will have no effect until the entire motion is completed or aborted by the STEPSTOP command. The STEPMOVEABS command is also used to specify whether the PLC is a motor controller, a full-step motor driver, or a half-step motor driver.

```
STEPMOVEABS ch, position, r
```

The *ch* parameter would specify which stepper motor channel is being used and should be a "1" on Nano-10.

The *position* parameter specifies how many pulses the motor will move relative to its home position.

The *r* parameter specifies which internal relay will be activated once the motor has moved to its new position. This relay would be cleared when the STEPMOVEABS command is executed in case it was already activated.

*Example:*

```
STEPMOVEABS 1,500,101  ` Stepper #1 to move fwd 500 steps  
                        ` from home and turn on relay 101
```

### **10.3.5 Demo Program for Stepper Motor Control**

A demo program for programming the Stepper Motor Controller and Driver:

“StepperMotor.PC6”

can be found in the Nano10Samples.zip file which can be downloaded from:

<http://www.tri-plc.com/trilogi/Nano10Samples.zip>

## Chapter 11 Pulse Width Modulated Outputs

## 11 PULSE WIDTH MODULATED OUTPUTS

### 11.1 Introduction

Pulse-Width Modulation (PWM) is a highly efficient and convenient way of controlling output voltage to devices with large time constants, such as controlling the speed of a DC motor, the power to a heating element, or the position of a proportional valve.

The PWM works by first turning on the output to full voltage for a short while and then shutting it off for another short while and then turning it on again, and so on, in consistent and accurate time intervals. This can be illustrated with the following diagram:

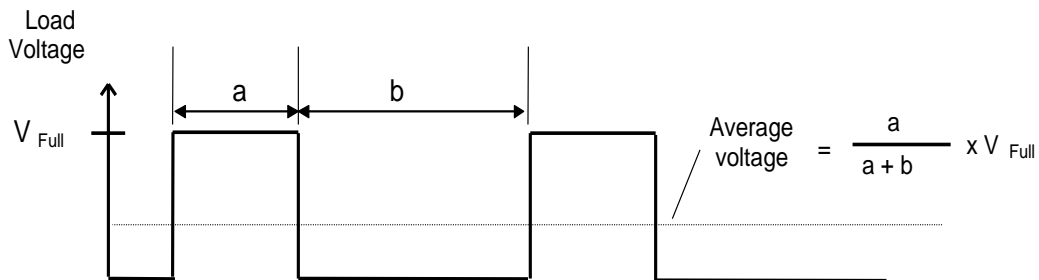

Figure 11.1

The average voltage seen by the load is determined by the “duty cycle” of the PWM waveform. The duty cycle is defined as follow:

$$\text{Duty Cycle} = \frac{a}{a + b} \times 100\%$$

$$\text{Period} = (a + b)$$

$$\text{Frequency} = 1/\text{period Hz}$$

Average voltage = % duty cycle multiplied by the full load voltage  $V_{Full}$ . Since the voltage applied to the load is either “Fully ON” or “Fully OFF”, it is highly efficient because the switching transistors are working in their saturated and cut-off region and dissipate very little power when it is fully turned ON.

### 11.2 Nano-10 PLC PWM Outputs

#### Technical Specifications:

No. of Channels	4
Duty Cycle range	0.00 to 100.00
Worst case resolution	0.1%
Available Frequencies (Hz)	50Hz to 50 KHz,
% Frequency Errors :	< $\pm 0.01\%$ @ 100Hz < $\pm 0.5\%$ @ 10KHz < $\pm 2\%$ @ 50KHz
Relevant TBASIC commands	<b>SETPWM</b>



Unlike in the T100M+ PLCs, which only support 8 fixed frequencies settings, the PWM channels in the Nano-10 PLC can generate pulses with frequency ranging from 50Hz all the way to 50KHz. At the lower frequency range, the output frequency can be extremely accurate (less than 0.01% error). Even at 10KHz the output frequency error is less than 0.5%. This makes it possible to use the PWM channels to generate square wave pulses of a certain frequency.

Usually it is better to select as high a frequency as possible because the resulting effect is smoother for higher frequencies. However, some systems may not respond properly if the PWM frequency is too high, in such cases a lower frequency should be selected.

The TBASIC `SETPWM` statement controls the frequency and duty-cycle settings of the PWM channel. The Nano-10 PLC features two channels of PWM on its digital outputs #1 and #2(PWM channel #1 and #2).

Since both PWM outputs are high voltage, high current outputs (24V, 4A peak, 2A continuous) they can be used to directly control the speed of a small DC motor. They can also directly drive proportional (variable position) valves whose opening is dependent on the applied voltage. **Note:** When using the PWM output to drive a motor or solenoid valve, please take note of the need to add a bypass diode to absorb the inductive kick that will occur when the output current to the load is turned OFF, as mentioned in Chapter 1.5.3.

### 11.3 Increasing Output Drive Current (Opto-Isolated)

The advantage of using the PWM is that you can easily amplify the drive current to a larger load such as a larger permanent magnet DC motor by using a power transistor or power MOSFET to boost the current switching capability. If the load is of a different voltage and the load current is high, you should use an opto-isolator to isolate the PLC from the load, as in Figure 11.2

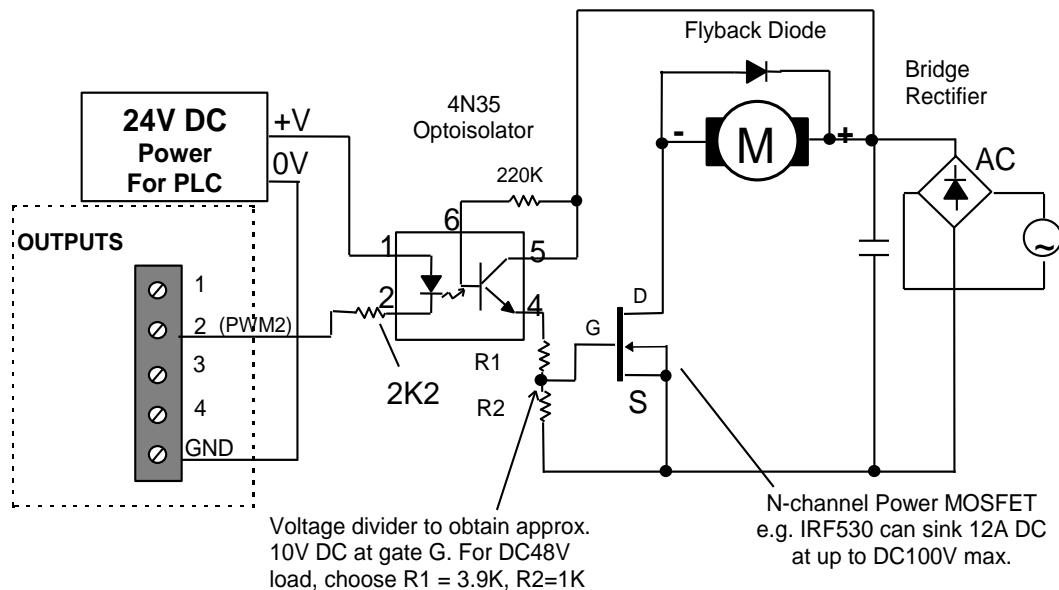

Figure 11.2 PWM Speed Control of a large DC Motor.

#### Note:

1. The opto-isolator must be able to operate at a frequency matching that of the PWM frequency, otherwise the resulting output waveform will be distorted and effective speed control cannot be attained.

- The simple PWM speed control scheme described above is the open-loop type and does not regulate the speed with respect to changing load torque. Closed-loop speed control is attainable if a tachometer (either digital or analog) is used which feeds back to the CPU the actual speed. Based on the error between the set point speed and the actual speed, the software can then adjust the PWM duty cycle accordingly to offset speed variation caused by the varying load torque. A PID function may also be invoked to provide sophisticated PID type of speed control.
- The Nano-10 PWM can be used to control the speed of small motors only (up to the maximum current limit that the PLCs output can safely drive). For larger motors, industrial-grade variable-speed drives should be used instead.

## 11.4 Position Control Of RC Servo Motor

RC Servo is a class of DC servo motor commonly used in remote control (hence the term RC) for positioning a device at a desired location. It is often termed “proportional control” because the position where the motor will turn to is directly proportional to the pulse width of the control signal. When chosen appropriately, RC Servo can provide an extremely inexpensive and versatile solution for positioning a device. For example, for controlling the percentage opening of a HVAC damper, or to rotate the angle of window blinds or to position a solar panel to track the sun light. There are many sizes of RC Servo available in the market, from those that weigh just a few grams to those for controlling an industrial scale unmanned vehicle (e.g. UAV or unmanned submarine). A small, self-contained RC servo typically cost **less than \$20** retail price and is incredibly easy to control using the Nano-10.

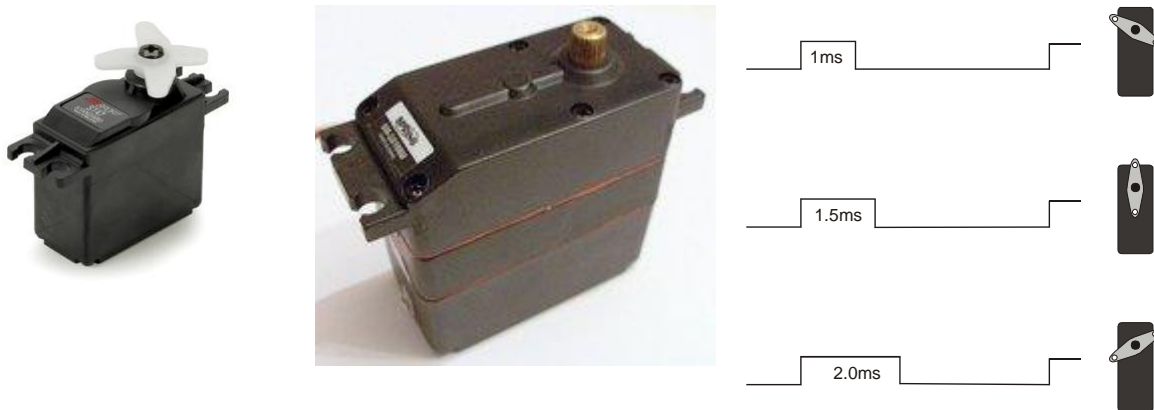

Figure 11.3 RC Servo and Control Signal

RC Servo typically only have 3 wires: Power “+” (typically 4.8 to 6V), “-” and a “Control” input.

To position the RC Servo to a position within its range of travel (Some are 0 to 90 degree and there are those that can go from 0 to 180 degree), you send a positive pulse with pulse width between 1.00 ms to 2.00 ms to the “Control” input once every 20ms. The servo will position the actuator to one end when it receives a pulse of 1.00ms and the other end when it receive a pulse of 2.00ms. If you send it a pulse of 1.50ms it will position the actuator to the center.

In PWM term, 1.00ms pulse width every 20ms means a duty cycle of  $1.00/20.00 = 5.00\%$ . 2.00ms pulse width every 20ms means a duty cycle of  $2.00/20.00 = 10.00\%$  duty cycle. So to control the position of the actuator one only needs to send it a positive PWM signal with frequency =  $1/0.02 = 50\text{Hz}$  and duty cycle between 5% and 10%.

The gear and servo feedback mechanism within the RC Servo produces a huge amount of torque relative to its weight for positioning the actuator to the position determined by the pulse width at the “control” input. Yet once it is in the correct position the servo draws only minimum current required to maintain its

position. Hence being a closed-loop controller an RC Servo is actually a much more efficient and effective positional control device (for a limited range) than a stepper motor which relies on a constant current in its winding to provide the “holding torque” for positioning. The open loop nature of stepper motor means that it does not know if the device is actually being knocked out of its desired location whereas in the Servo any deviation from its desired location is instantly being corrected by the servo mechanism.

### 11.4.1 Using Nano-10 PWM Output To Control RC Servo (Non-Isolated)

As you probably have realized by now that you can use a single PWM output to very easily position the RC Servo to whatever position within its range of travel.

However, since the Nano-10 power supply is 24V (vs 4.8 to 6V on the typical RC Servo) and the PWM output is NPN (current sink) type, the signal to the servo is actually inverted if you connect the PLC's output to the Servo's “control” input directly.

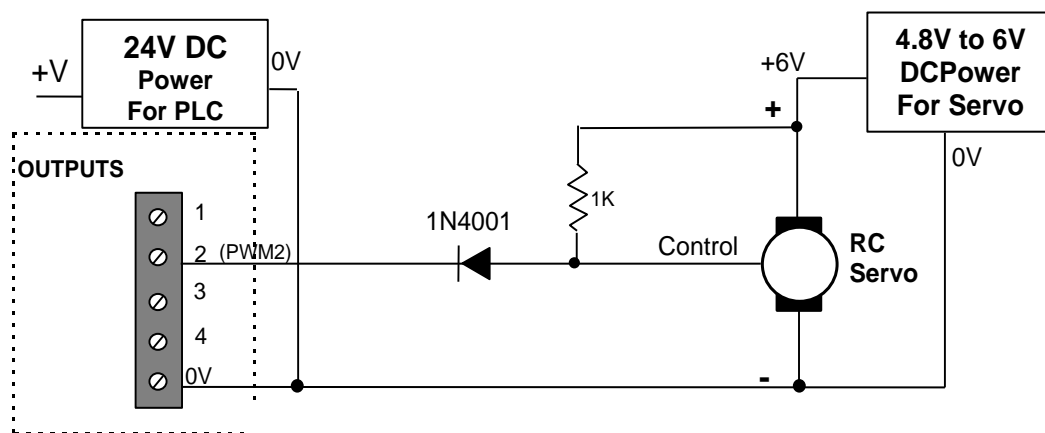

Figure 11.4 Non-isolated Interface to RC Servo

As shown in the above figure, we use a 1K ohm resistor to pull up the “Control” input to the RC Servo's power supply so that when the PLC's output is OFF, the Control input is +6V and when the PLC output is ON, the “Control” input is pulled to low.

The 1N4001 diode is to prevent the 24V weak pullup signal at the PLC output from entering the servo's “Control” input. As such, when the PLC output is ON, the “Control” input is pulled down to about 1 diode drop (about 0.7V).

In other words, the RC Servo connected above are controlled by the PLC's PWM output but the duty cycle is inverted. I.e. To send a 5% positive PWM control pulse to the Servo, you can run the following statement:

```
SETPWM 2, 9500, 50    \ Set PWM 2 output to 95% duty cycle at 50 Hz
```

Likewise, to send a 10% positive PWM control pulse to the Servo, you will need to run the following statement:

```
SETPWM 2, 9000, 50    \ Set PWM 2 output to 90% duty cycle at 50 Hz
```

### 11.4.2 Using Nano-10 PWM Output To Control RC Servo (Opto-Isolated)

You can also use the PLC's PWM output to drive an optocoupler (such as 4N35) and the output from the optocoupler is use to provide control pulse to the RC Servo, as shown in Figure 11.5

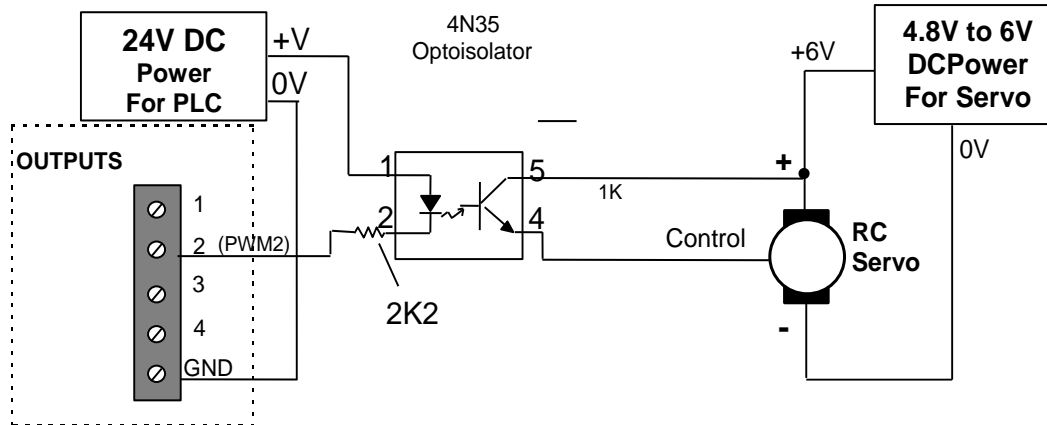

Figure 11.5 Opto-Isolated Interface to RC Servo

In the opto-isolated interface shown above, the power supply to the PLC and that to the RC Servo are completely isolated (no common ground required). Also since the interface inverts the output signal from the PLC, no software inversion is necessary. i.e When the PLC NPN output is OFF, the “control” input to the RC Servo will be OFF, and when the PLC NPN output is ON, the “control” input to the RC Servo = +6V.

Hence, to send a 5% positive PWM control pulse to the Servo, you can run the following statement:

```
SETPWM 2, 500, 50    \ Set PWM 2 output to 5% duty cycle at 50 Hz
```

Likewise, to send a 10% positive PWM control pulse to the Servo, you can run the following statement:

```
SETPWM 2, 1000, 50   \ Set PWM 2 output to 10% duty cycle at 50 Hz
```

Of course you can replace the duty cycle with a value (e.g. DM[1]) and run statement such as:

```
SETPWM 2, DM[1], 50  \ Set PWM 2 output to DM[1]/100% duty cycle at 50 Hz
```

### 11.4.3 RC Servo Positioning Resolution

Since the resolution on the Nano-10 PLC's PWM output is precise to 0.01% at 50Hz, this means that you can get a maximum of **500** discrete positions within the travel range of the RC Servo. This should be sufficiently accurate for many applications such as HVAC damper control or control of proportional valves. The actual positioning accuracy and precision, however, will depend on the quality of the RC Servo.

## Chapter 12 Real Time Clock

## 12 REAL TIME CLOCK

### 12.1 Introduction

A Real Time Clock (RTC) is a device that keeps accurate date and time information down to the second. The Nano-10 has a built-in Real Time Clock that provides calendar and time data for year, month, date, day of week, hour, minute and second, but it is not battery-backed. You can however easily add an optional battery-backed FRAMRTC module and the Nano-10 will sense it automatically and use it upon installation.

#### NOTE:

If the RTC battery is not installed or the battery is removed for more than 15 seconds from the FRAMRTC, then the PLC will lose its real time clock data when it is powered up even with the FRAMRTC installed. When this happens the RTC.Err bit in the ladder logic special bit will be ON so that user program can use it to alert the operator. The PLC can also use the RTC.Err bit to trigger an automatic RTC update from an Internet Time Server or from a TLServer that it connects to.

### 12.2 TBASIC variables Used for Real Time Clock

Date		Time	
YEAR	DATE[1]	HOUR	TIME[1]
MONTH	DATE[2]	MINUTES	TIME[2]
DAY	DATE[3]	SECOND	TIME[3]
Day of Week	DATE[4]		

There are 7 registers available in TBASIC that are used to access and configure the date and time. These registers, which are shown above, can be read from and written to just like any other integer variable. The data for these registers are in integer format.

- DATE [1] : may contain four digits (e.g. 1998, 2003 etc).
- DATE [4] : 1 for Monday, 2 for Tuesday, .... 7 for Sunday.

### 12.3 RTC Error Status On Ladder Logic

There is a special bit available in TRiLOGI that allows you to notify the PLC program if the RTC Error event occurs and the RTC Error status light is turned on. The RTC Error event occurs if the RTC is corrupted or damaged (see section 12.8 for more detail) or if the battery is not installed. The special bit is called RTC.Err and can be obtained from the "Special Bits" I/O Table. The RTC.Err contact can be used to activate an alarm of some kind. The following ladder logic circuit is an example of this using the RTC.Err bit as an input that controls an output called RTC\_Alarm:

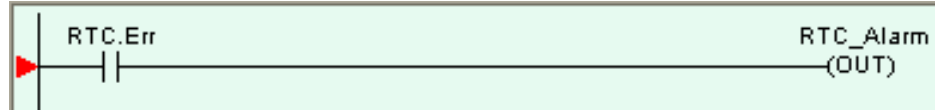

In the circuit above, RTC.Err is a special bit that cannot be renamed in your program. The output RTC\_Alarm is a user-defined output that could be named to anything. If the RTC Error event occurs for any reason, the RTC.Err bit would activate the RTC\_Alarm output.

## 12.4 Setting the RTC Using TRiLOGI Software

The RTC date and time can be easily set within TRiLOGI by selecting “Set PLC’s Real Time Clock” from the “Controller” menu. A window will pop up with default values entered as shown below in Figure 12.1. All of these values can be edited and then written to the PLC by clicking on “Set PLC’s Clock”



Figure 12.1: Set Real Time ClockSetting the RTC Using TBASIC

The PLCs RTC can be set from TBASIC using the DATE[] and TIME[] registers shown in section 12.2. Figure 12.2: Set Date & Time in TBASIC, shown below, is an example of a custom function where the date is set to October 1<sup>st</sup> 2008, the day of the week is Wednesday, and the time is 14:30:01 (2:30:01 pm).

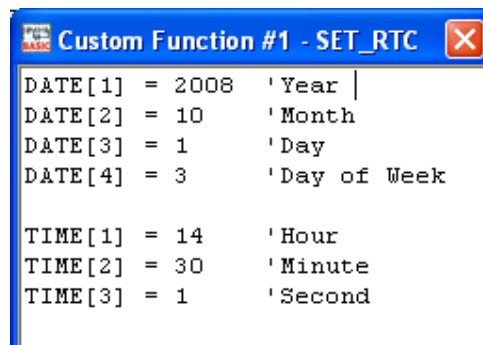

Figure 12.2: Set Date & Time in TBASIC

## 12.5 Setting the RTC from Internet Time Server

Please refer to [Section 2.5](#) for more detailed information on how your PLC may be able to automatically set its own real time clock using the time server data available on the Internet. A sample program is also included in that section.

## 12.6 Setting up an Alarm Event in TBASIC

Since, to the TBASIC program, the RTC data are simply integer arrays DATE[1] to DATE[4] and TIME[1] to TIME[3], they are fully accessible at any time by your PLC program. Therefore, if you want your program to execute a certain routine on a specific date and or/time, you would need to periodically check these variables against the desired settings and activate the action when the RTC variable(s) reach the set value.

Example: Set up a 1 minute clock pulse to monitor the RTC as follows:

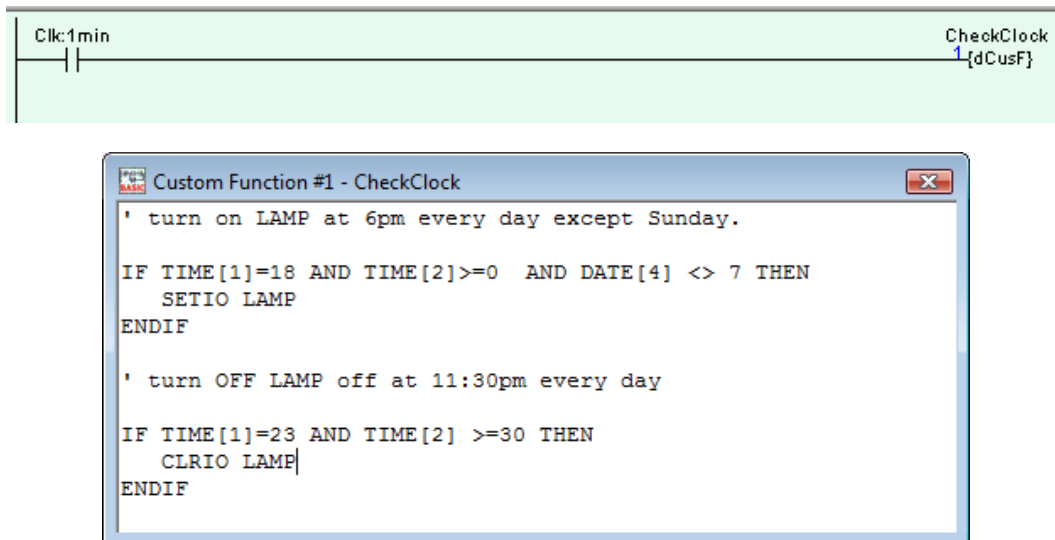

Figure 12.3: Using Real Time Clock Example

## 12.7 Retrieving RTC Clock values using STATUS (18)

For Nano-10 PLC with firmware version r72 and above, you can read the hour, minute and second of the Nano-10 RTC in a single STATUS(18) function. The RTC hours, minutes and second values are returned as a single integer in the following format: hhmmss.

This could be faster and more convenient to use than to perform 3 comparison statements using TIME[1], TIME[2] and TIME[3]. However, please note that this function is not available on the M-series PLC or F-series PLC with older firmware version and it is currently not supported by the i-TRiLOGI version 6.30 simulator. You will need to transfer your program to the PLC in order to test it.



Example

Time	STATUS(18)
0:0:0	0
0:1:5	105
10:5:3	100503
23:59:59	235959

You can therefore easily test the value of the RTC using a single command:

```
E.g.  IF STATUS(18) >= 100000  ` After 10 am in the morning
      SETIO Pump
      ENDIF
```

## 12.8 RTC Calibration (For FRAMRTC only)

The RTC calibration routine is only applicable to the FRAMRTC module installed on a Nano-10 PLC. The FRAMRTC uses a battery-back real time clock that derived its clock from a 32.768KHz crystal, which should provide reasonably good accuracy for normal use. However, if you like the FRAMRTC to be of greater accuracy, you can calibrate it using the “Advanced Configuration” page of the “Ethernet Configuration Tool” in the PLC configuration routine mentioned in Chapter 2. The data field to be used is the “RTC Calib” textbox as shown below:

RTC Calib ±  seconds/(72 hours)

In the above field you will need to enter the number of seconds that you want the PLC to add or subtract over a period of 72 hours. Therefore, first you must check the PLC’s RTC reading against a super accurate clock source (e.g. a clock that regularly updates itself with atomic clock data in the airwaves) and find out how many seconds the clock would have gained or lost over 72 hours.

For example, if the RTC is too slow and it loses 5 seconds over 72 hours, you would want the RTC to add 5 seconds over 72 hours and you therefore should enter the value of +5 in the “RTC Calib ±” field. If the RTC is too fast and gains 8 seconds over the 72 hours, then you should enter a value of “-8” in this field to compensate for the inaccuracy.

Note that the RTC does not compensate for temperature variation. Hence, its accuracy is temperature-dependent. If you require the PLC’s RTC to be very accurate you should keep the PLC under a constant operating temperature.

If your Nano-10 is connected to a LAN, then you also have the option of having the RTC periodically set itself using the very accurate RTC data that can be obtained from a time-server on the Internet (See [Section 2.5](#)).

---

## 12.9 Control of RTC Hardware

On Nano-10 PLC with r72 and above firmware, you can use the following command to control the RTC hardware:

```
SETSYSTEM 253,n  
  
n = 0  \ Stop built-in RTC  
      1  \ Run built-in RTC  
      2  \ Disable auto RTC update from FRAMRTC  
      3  \ Enable auto RTC update from FRAMRTC
```

An example program “RTCcontrol.PC6” is included in the “Nano10Samples.zip” file that you can download from: <http://www.tri-plc.com/trilogi/Nano10Samples.zip>

---

## 12.10 Troubleshooting the FRAMRTC

If the RTC.Err bit is ON (indicating a bad RTC) and the battery is properly installed on the FRAMRTC, then the RTC component on the FRAMRTC could be corrupted or damaged. This could happen if there was any damage to the components on the board, such as I/O drivers, communications drivers, or any of the IC's or PCB circuitry. Also, if a voltage spike came into the PLC through its I/O, power supply, or communications ports, that could cause some corruption even if there was no component damage.

If the RTC is only corrupted, then you should only have to set the RTC to resolve the problem. This can be done most easily by using the TRILOGI method of setting the RTC that was described in section 12.4. After setting the RTC, the PLC should be powered off and then powered on again. The RTC.Err bit should be off at this point, but if it isn't, then there is a possibility of damage to the PLC. At this point you should contact Triangle Research tech support or if you have purchased the unit from a local distributor, then you should contact the distributor for assistance.

## Chapter 13 LCD Display Programming

## 13 LCD DISPLAY PROGRAMMING

Although the Nano-10 PLC lacks a connector for connecting to a physical LCD display, it does support the SETLCD command available to all the M-series and F-series PLC. The content of the non-existent LCD display however can still be displayed as a “Virtual LCD” screen using the I-TRiLOGI On-line monitoring function. Thus the SETLCD command can still be an effective debugging tool for the PLC to display internal or computed data.

The LCD content is also accessible from a web browser using the appropriate web services commands. Hence it can still be extremely useful for a Nano-10 to use the SETLCD command to manipulate its virtual LCD display, and the content is visible on the user configurable control web page (described in [Section 2.10](#) for controlling the Nano-10 PLC using a web browser. The virtual LCD would then become a real display on the web browser.

If you require a physical LCD display to be used with the Nano-10 PLC, then there are many options, One of which is to purchase an RS485 based [MDS100-BW](#) that is produced by TRi. However, it is important to note that what we describe in this chapter is not applicable to MDS100-BW. MDS100-BW is a peripheral device and it is controlled by a set of communication protocol described in the [MDS100-BW installation guide](#).

### 13.1 SETLCD Command

The SETLCD *y*, *x*, *string* TBASIC command allows you to easily display any string of up to 20 characters on the *y*<sup>th</sup> line starting from the *x*<sup>th</sup> column. E.g., to display the message “Super Nano-10” on the 3<sup>rd</sup> line starting from the 5th character position from the left end of the screen, you use the command:

```
SETLCD 3, 5, "Super Nano-10"
```

Normally, *y* = 1,2,3, 4; *x* = 1, 2, .... 20. Integers must be converted to strings using the STR\$( ) or HEX\$( ) function before they can be displayed using SETLCD. You can use the concatenation operator “+” to combine a few components together in the command. E.g.

```
SETLCD 1,1,"Rm Temp = "+STR$(ADC(1)/100,3)+CHR$(223)+"C"
```

The function STR\$(ADC(1)/100,3) reads the content of ADC channel #1, divides it by 100 and converts the result into a 3-digit string. The CHR\$(223) appends a special character which corresponds to the ‘°’ symbol. E.g. if ADC(1) returns the value 1234, the final string being displayed will be :

Rm Temp = 012 °C.

### 13.2 Special Commands For LCD Display

If you use the SETLCD command with line #0, then the strings will be treated as special “instructions” to be sent to the LCD module to program it for various modes of operation. This includes: blinking cursor, underline cursor or no cursor, as well as display shift mode. You have to refer to the LCD manufacturer’s data sheet for the detailed commands. Some of the most useful commands are listed below:

Action	Command
1. Clear screen	SETLCD 0,1, CHR\$(1)
2. No cursor	SETLCD 0,1, CHR\$(12)
3. Underline Cursor	SETLCD 0,1, CHR\$(14)
4. Blinking Cursor	SETLCD 0,1, CHR\$(13)
5. Underline + Blinking Cursor	SETLCD 0,1, CHR\$(15)

### 13.3 Displaying Numeric Variable With Multiple Digits

The "SETLCD *y*, *x*, *string*" command only overwrites the exact number of characters in the *string* parameter to the LCD display, and thereafter the cursor is placed back to the location specified by the *x* and *y* parameters. Thus if there exists some old characters right after the last character it can cause confusion, especially if you are displaying a number. E.g. If you first display the following string at row 1 and column 1:

```
Pressure = 12345
```

And if you subsequently display the string "Pressure = 983" at the same location without first clearing the line, then you will see the following string being displayed:

```
Pressure = 98345
```

What happens is that the string "Pressure = 983" is correctly displayed but the two old characters "45" left over from previous display would appear to be part of the new data. This can cause confusion.

There are several ways you can eliminate such a display problem:

- 1) Clear the line first before overwriting with a new string. You can create a custom function just to clear a particular line. E.g. if you pass the parameter DM[100] to the custom function and inside the custom function you do the following:

```
SETLCD DM[100],1, "          "
```

Hence calling this custom function with DM[100] = 1,2,3, or 4 would clear the corresponding line.

- 2) A "quick and lazy" way to do it is to add a few more characters to the back of the string to be displayed which will wipe out old characters that could be present adjacent to the new string.

E.g. SETLCD 1,1, "Money = \$" + STR\$(D) + " "

- 3) If there is data to the right of the currently displayed string that you cannot overwrite with spaces, then you can restrict the number of digits that a numeric variable may be converted to using the two parameters from the STR\$ or HEX\$ command.

E.g. SETLCD 1,1, "Temp = " + STR\$(T,4)

The STR\$(T,4) function will always return 4 digits of the data stored in T. If T is less than 4 digits, then one or more preceding "0"s will be added. E.g. if T = 12 then this function will return the string "0012". Note that for negative numbers the negative sign is counted as part of the digit count so you need to provide enough spaces to take care of the sign if you need to handle both positive and negative numbers.

## 13.4 Displaying Decimal Point

Although the Nano-10 PLC does not handle floating-point computation, it is still possible to perform computations involving fractions by using “fixed point” notation. E.g. If each unit represents 0.01, then the number 1234 represents the value 12.34.

It is quite simple to display a number on the LCD display with a decimal point as follows: You first divide the numeric variable by 100 to obtain the integer component (i.e. the portion to the left of the decimal point) and use the MODULUS operator to obtain the decimal component (i.e. the portion to the right of the decimal point) of the number. So to display a number contained in X with two decimal places, do the following:

E.g. `SETLCD 1,1, "Data="+STR$(X/100)+"."+ STR$(X MOD 100)`

Hence, if the number  $X = 12345$ , then  $(X/100 = 123)$  and  $(X \text{ MOD } 100 = 45)$  and the above would display the string “Data=123.45”.

## Chapter 14 Serial Communications

## 14 SERIAL COMMUNICATIONS

### 14.1 Introduction:

There is only a single, RS485 serial port on the Nano-10 PLC. This serial port supports full Modbus ASCII/RTU and Host Link Protocol drivers and it can also be programmed to accept or send ASCII or binary data using the TBASIC built-in commands such as INPUT\$(n), INCOMM(n), PRINT #n, OUTCOMM n, d.

This serial port is designated as COMM1 to the TBASIC and it is a two-wire RS485 port that allows multiple PLCs to be connected to a single host computer or a master PLC for networking or to implement a distributed control system.

---

### 14.2 COMM1: Two-wire RS485 Port

This half-duplex RS485 ports is meant for serial bus type networking or for connecting to optional peripherals such as a serial LCD message-display unit (e.g. [MDS100-BW](#)), external analog modules (e.g. [I-7018](#)), touch panel HMI, or it can be used for inter-communication between PLCs.

Up to 255 RS232/RS485 peripheral devices may be linked together in an RS485 network on this port.

The RS485 port signal is carried on a 2-way screw terminal connector (please refer to Chapter 1-Installation Guide). For successful communication using the RS485 port, you need to correctly connect the '+' and '-' terminals to the RS485 equipment using a twisted pair cable. If you are using the PC as the network host, you will need an USB-to-RS485 converter such as the [U-485](#) converter.

The following describes some possible uses of the RS485 ports.

#### 14.2.1 PROGRAMMING AND MONITORING

The Nano-10 PLC can be programmed via its RS485 port on a one-to-one or multi-drop manner. If your PC already has an RS232 port or you already own a USB-to-RS232 converter, then you can convert the RS232 port into RS485 port using the [Auto485](#) adapter in order to communicate with the PLC.

If your PC only has USB ports, then the easiest way is to purchase a USB-to-RS485 adapter ([U-485](#)), which is port-powered so you only need to connect two wires from the U-485 to the PLC's RS485 port to establish communication.

Programming via COMM1 is particularly useful if the Nano-10 PLC is not yet connected to the LAN, and if your PC does not have a spare Ethernet port for direct connection (see [Section 2.8](#)) that can be used for programming. Another reason for programming via RS485 is if your Ethernet port default IP address is not compatible with the subnet of your network. You will then need to connect i-TRiLOGI to the PLC via RS485 port in order to change the IP address.



### 14.2.2 Accessing 3<sup>rd</sup> Party RS485-based Devices

There are more and more industrial devices such as electric power meters, analog I/O modules (e.g. the I-70xx modules by ICPDAS), variable frequency drives, servo controller, etc that allows data communication via their RS485 port. The Nano-10 PLC can readily use its RS485 port to communicate with these devices. The PLC has many built-in commands for reading/writing to the serial port, including built-in commands for communicating with devices that deploy the MODBUS ASCII or RTU protocols.

### 14.2.3 Interfacing Other Devices to Modbus/TCP Host or to the Internet

Since the Nano-10 PLC supports serial MODBUS protocols, it can operate as a master PLC and serve as a gateway to interface non MODBUS-enabled PLCs (such as the H-series and E10+ PLCs, or the I-7000 analog modules) to third party SCADA software or MMI hardware that speaks MODBUS. The Nano-10 PLC also makes it easy for these devices to be controlled or monitored over the Internet. The master Nano-10 will use its RS485 port to pull data from these devices into its data-memory. The data memory in the Nano-10 is in turn accessible by a SCADA program using the Modbus/TCP protocol. Through the Nano-10 PLC, these other connected devices thus become accessible from the Internet.

### 14.2.4 Distributed Control

Another important use of the RS485 port will be to connect a Nano-10 PLC to other Nano-10, F-Series, M-series, H-series or E10+ PLCs. One of these PLCs will act as the master and all other PLCs will act as slaves. Each PLC must be given a unique ID. The master will send commands to all the slaves using the "NETCMD" or READMODBUS, WRITEMODBUS, READMB2, WRITEMB2 statements and coordinate information flow between the PLCs. In this way, a big system can be built by employing multiple units of Nano, F, M, E or H-series PLCs connected in a network. This results in more elegant implementation of complex control systems and simplifies maintenance jobs.

---

## 14.3 Changing Baud Rate and Communication Formats: Use of the SETBAUD Statement

The Nano-10 PLC's COMM port is highly configurable. It can be set to a wide range of baud rates. You can also program it to communicate in either 7 or 8 data bits, 1 or 2 stop bits, odd, even or no parity. The baud rate and communication formats of the serial port are set by the following command:

```
SETBAUD  ch, baud_no
```

*ch* represents the COMM port number (1 only). The *baud\_no* parameter takes a value from 0 - 255 (&H0 to &HFF), which allows for additional configuration of the communication format. The upper 4 bits of *baud\_no* specify the communication format (number of data bits, number of stop bits, and parity) and the lower 4 bits represent the baud rate. Hence the *baud\_no* for 8 data bit, 1 stop bit, and no parity is the same as the old models, providing compatibility across the PLC families.

Once the new baud rate has been set, it will not be changed until execution of another SETBAUD statement. The baud rate is not affected by a software RESET but the settings will be lost when the power is turned OFF. The available baud rates and their corresponding baud rate numbers for COMM1, 2, and 3 are shown below:

Format	<i>baud_no</i>	Format	<i>baud_no</i>
--------	----------------	--------	----------------

8, 1, n	0000 xxxx	8, 2, n	0001 xxxx
8, 1, e	0100 xxxx	8, 2, e	0101 xxxx
8, 1, o	0110 xxxx	8, 2, o	0111 xxxx
7, 1, n	1000 xxxx	7, 2, n	1001 xxxx
7, 1, e	1100 xxxx	7, 2, e	1101 xxxx
7, 1, o	1110 xxxx	7, 2, o	1111 xxxx

Where xxxx represents the baud rate of the comm port, as follow:

<b>x x x x</b>	0000	0001	0010	0011	0100	0101	0110	0111
<b>Baud Rate</b>	2400	2400	4800	9600	19200	31250	38400	57600

<b>x x x x</b>	1000	1001	1010	1011	1100	1101	1110	1111
<b>Baud Rate</b>	100K	115.2K	230.4K	110	150	300	600	1200

A table of all the available baud rates and COMM formats is shown in the following page. The communication format written as “7,2,e”, which means 7 data bits, 2 stop bits and even parity. Likewise, “8,1,n” means 8 data bits, 1 stop bit and no parity. You can use the table to select the baud number for a certain baud rate and COMM format. COMM1 can work at high baud rate of up to 230.4 K bps.

**Baud No Table (All numbers in Hexadecimal: &H00 to &HFF)**

<b>Format \ Baud</b>	<b>8,1,n</b>	<b>8,1,e</b>	<b>8,1,o</b>	<b>7,1,n</b>	<b>7,1,e</b>	<b>7,1,o</b>	<b>8,2,n</b>	<b>8,2,e</b>	<b>8,2,o</b>	<b>7,2,n</b>	<b>7,2,e</b>	<b>7,2,o</b>
110	0B	4B	6B	8B	CB	EB	1B	5B	7B	9B	DB	FB
150	0C	4C	6C	8C	CC	EC	1C	5C	7C	9C	DC	FC
300	0D	4D	6D	8D	CD	ED	1D	5D	7D	9D	DD	FD
600	0E	4E	6E	8E	CE	EE	1E	5E	7E	9E	DE	FE
1200	0F	4F	6F	8F	CF	EF	1F	5F	7F	9F	DF	FF
2400	01	41	61	81	C1	E1	11	51	71	91	D1	F1
4800	02	42	62	82	C2	E2	12	52	72	92	D2	F2
9600	03	43	63	83	C3	E3	13	53	73	93	D3	F3
19200	04	44	64	84	C4	E4	14	54	74	94	D4	F4
31250	05	45	65	85	C5	E5	15	55	75	95	D5	F5
38400	06	46	66	86	C6	E6	16	56	76	96	D6	F6
57600	07	47	67	87	C7	E7	17	57	77	97	D7	F7
100K	08	48	68	88	C8	E8	18	58	78	98	D8	F8
115K2	09	49	69	89	C9	E9	19	59	79	99	D9	F9
230K4	0A	4A	6A	8A	CA	EA	1A	5A	7A	9A	DA	FA

**E.g.** To set the baud rate of COMM1 to 19200, 7 data bit, 1 stop bit and even parity, execute the statement: SETBAUD 1, &HC4

**Important:** Please note that if you change the baud rate or communication format of the COMM port to something that is different from that set in the **TLServer**, then both the TLServer and TRiLOGI will no longer be able to communicate with the PLC via this COMM port. You will have to either configure the TLServer’s serial port setting using its “Serial Communication Setup” routine to match the PLC, or you can cycle the power to the PLC to reset the COMM port to the default format (38,400, 8,n,1).

If you had used “1st.Scan” contact to activate the SETBAUD command than you will need to cycle the power to the PLC with Jumper J4 shorted to halt the execution of the SETBAUD command. When the PLC is reset this way, its COMM1 will power up at the default format of 38,400, 8,n,1 only so you will need to configure TLServer’s serial port to 38,400bps to communicate with it.

---

## 14.4 Support of Multiple Communication Protocols

The Nano-10 PLC is a real communication wizard! It has been designed to understand and speak many different types of serial communication protocols, some of which are extremely widely used *de facto* industry standards, as follows:

- a) NATIVE HOST LINK COMMAND
- b) MODBUS ASCII (Trademark of Modbus.org)
- c) MODBUS RTU\* (Trademark of Modbus.org)
- d) OMRON C20H protocols. (Trademark of Omron Corp of Japan)

The command and response formats of the “NATIVE” protocols are described in detail in Chapter 15 and 16. The other protocols and their address mapping to the Nano-10 PLC are described in Section 14.7. Each COMM port can communicate using the same or different protocols, independent of the other. The most wonderful feature of Nano-10 PLCs is that the support of all the above-mentioned protocols can be fully automatic and totally transparent to the users. There is no DIPswitch to set and no special configuration software to run to configure the port for a specific communication protocol. The following describes how the automatic protocol recognition scheme works:

1. When the PLC is powered ON, the COMM1 port is set to the “AUTO” mode, which means that they are open-minded and listen to all serial data coming through the COMM ports. The CPU tries to determine if the serial data conforms to a certain protocol and if so, the COMM mode is determined automatically.
2. Once the protocol is recognized, the CPU sets that COMM port to a specific COMM mode, which enables it to process and respond only to commands that conform to that protocol. Error detection data such as the “FCS”, “LRC” or CRC are computed accordingly which method is used to verify the integrity of the received commands. If errors are detected in the command, the CPU responds in accordance with the action specified in the respective protocols.
3. When the COMM port enters a specific COMM mode, it will regard commands of other protocol as errors and will not accept them. Hence, for example, if COMM #1 has received a valid MODBUS RTU command (which puts it in an “RTU” mode), it will no longer respond to TRiLOGI's attempts to communicate with it using the “NATIVE” mode. You will receive a communication error if you try to use TRiLOGI to access a PLC COMM port that has just been communicating in other protocol modes.
4. To improve the flexibility of switching from one COMM mode to another, The Nano-10 incorporates a COMM mode self-reset timer such that a specific COMM mode will time out automatically and enters into “AUTO” mode after 10 seconds if no more commands are received from that COMM port. When a user wants to switch from one COMM mode to another, he/she often will be changing the serial connector from one device to another. During this time there is no data received by the COMM port, which presents an opportunity for it to reset its COMM mode. However, the surest way to reset the specific COMM mode is to cycle the power to the PLC so that its COMM port will be reset to “AUTO” mode and ready to communicate with any supported protocols.
5. If you wish to use the COMM port for serial data input only, you can use the **SETPROTOCOL** command to set the COMM port to **NO PROTOCOL**. This can prevent the PLC from erroneously treating some serial data as the header of an incoming communication protocol and respond to it automatically.

The **SETPROTOCOL** command can also be used to set the PLC to a specific protocol. This may be desirable if the COMM port has a specific role and you do not want it to enter other modes by mistake.

Please refer to the TBASIC Programmer's Reference manual for a detailed description of the SETPROTOCOL command.

**Note:** If you fix a COMM port to a non-native, non-auto mode, TRiLOGI will not be able to communicate with the PLC anymore. You may have to power-cycle the PLC to reset the COMM mode. If you use the "1st.Scan" contact to activate the SETPROTOCOL command, then you will need to cycle the power to the PLC with Jumper J4 shorted to halt the execution of the SETPROTOCOL command. (Also remember that when the PLC is reset this way, its COMM1 will power up at default format of 38,400, 8,n,1 only so you will need to configure TLServer's serial port to 38,400bps to communicate with it.)

---

## 14.5 Accessing the COMM Port from within TBASIC

Besides responding automatically to specific communication protocols described in section 14.5, the COMM #1 is fully accessible by the user program using the TBASIC commands: INPUT\$, INCOMM, PRINT # and OUTCOMM. It is necessary to understand how these commands interact with the operating system, as follow:

When a COMM port receives serial data, the operating system of the Nano-10 automatically stores them into a 256 bytes circular buffer so that user programs can retrieve them later. The serial data are buffered even if they are incoming commands of one of the supported protocols described in section 14.5. In addition, processing of a recognized protocol command does not remove the characters from the serial buffer queue so these data are still visible to the user's program.

As long as the user-program retrieves the data before the 256-byte buffer is filled up, no data will be lost. If more than 256 bytes have been stored, the buffer wraps around and the oldest data is overwritten first and so on. The following describes how INCOMM and INPUT\$, PRINT # and OUTCOMM functions interact with the serial buffer:

a) INCOMM(n)

Every execution of the INCOMM(n) function removes one character from the circular buffer. When no more data is available in the buffer this function returns a -1. The data removed by INCOMM will no longer be available for the INPUT\$(1) command.

b) INPUT\$(n)

When the INPUT\$(1) function is executed, the CPU checks the COMM1 buffer to see if there is a byte with the value 13 (the ASCII CR character) which acts as a terminator for the string. If a string is present, all the characters that make up the string will be removed from the COMM1 buffer. If a completed string is not present, then the COMM1 buffer will not be affected, and INPUT\$(1) returns an empty string. This ensures that before a complete string is received, the serial characters will not be lost because of the unsuccessful execution of the INPUT\$(1) function.

c) INPUT\$(n) in Blocking Mode

INPUT\$(n) is designed to be non-blocking and to return immediately – i.e. either it returns a complete string or it returns an empty string. This means that INPUT\$(n) will not suspend the CPU and wait for a valid string from the COMM port. However, in real world communication very often you will need to send a command to a device and it takes a while for the device to be able to send back a response string.

The most efficient way of handling such serial communication exchange with other devices is to send a command string using the PRINT #n and then start a timer and let the PLC program continue to scan the ladder program. When timer times out, the timer contact is used to activate a custom function and use INPUT\$(n) to read the return message from the device. This is most efficient use of the CPU time since the program will not have to waste time to wait for response string from the device and that's the reason for INPUT\$(n) to default to non-blocking mode.

Another way to deal with this is to use the NETCMD\$ function (terminated with "~"). NETCMD\$ sends a command string and will return immediately when it receives a response string or if more than 0.15s has passed. If the device is slow to response the CPU basically sits in a loop to wait for the response for up to a maximum of 0.15s. NETCMD\$ function also re-tries the communication several times if it does not receive a response in the first try.

A third way of handling serial exchange with other devices is to use the INPUT\$(n) command in **blocking mode**. Starting from CPU firmware r72 and above, if you run the command

```
SETSYSTEM 19, t
```

This will configure the INPUT\$(n) command to block the CPU for up to maximum of (t x 10) milliseconds to wait for a valid string from 3<sup>rd</sup> party device. Although this command also wastes CPU cycles to wait for a response and hence it is not as efficient compared to using the timer-activated method mentioned above, it nonetheless is very simple to implement and can be used for non time-critical applications.

You only need to execute SETSYSTEM 19, t once and INPUT\$(n) will block for the same t x 10 millisecond every time it is executed until SETSYSTEM 19,t is run again. To return the INPUT\$(n) to non-blocking mode, run SETSYSTEM 19, 0.

d) PRINT #n

The PRINT statement transfers its entire argument to a 256 byte serial-out buffer, which is separate from the serial-in buffer. The PRINT statement, therefore, does not affect the content of the serial buffer for incoming characters. The operating system handles the actual transfer of each byte of data out of the serial-out buffer in a timely manner.

Note that the PLC automatically enables the RS485 transmit driver when it sends serial characters out of its RS485 port. When the stop bit of the last character in the serial-out buffer has been sent out, the operating system immediately disables the RS485 driver and enables the receiver. This greatly eases the use of the RS485 port since there is no need for a user to bother with the often-critical timing of controlling the RS485 driver/receiver direction.

d) OUTCOMM

This command sends only a single byte out of the serial COMM port without going through the serial out buffer. It enables the RS485 transmitter before sending the character and disables it immediately after the last stop bit has been sent out.

## 14.6 Using The PLC As a Modbus / Omron Slave – SCADA, HMI Applications

The Nano-10 PLC supports a subset of the OMRON™ C20H and MODBUS™ (Both ASCII and RTU modes are supported) compatible communication protocols so that it can be easily linked to third-party control software/hardware products such as SCADA software, LCD touch panels etc. The PLC automatically recognizes the type of command format and will generate a proper response. These are accomplished without any user intervention and without any need to configure the PLC at all!

Both MODBUS and Omron protocols use the same **device ID address** (00 to FF) as used by the native “Hostlink Command” protocol described in Chapter 15. Since the addresses of I/O and internal variables in the Nano-10 PLC are organized very differently from the OMRON or Modicon PLCs, we need to **map** these addresses to the corresponding memory areas in the Modbus address space so that they can be easily accessed by their corresponding protocols.

All I/Os, timers, counters, internal relays and data memory DM[1] to DM[4000] are mapped to the Modbus Holding Registers space. The Inputs, Outputs, Relays, Timers and Counters bits are mapped to the MODBUS Bit address space as shown in Table 14.1. Note that input and output bits are always mapped according to Table 14.1 whether it is MODBUS function 01, 02 or 05.

However, 32 bit variables and string variables are not mapped since they are fundamentally quite different in their implementation among different PLCs. Internal variables that are not mapped can be still be accessed by copying the contents of these variables to unused data memory DM[n] (this can be easily accomplished within a CusFn) so that they can be accessed by these third party protocols.

### 14.6.1 MODBUS ASCII Protocol Support

The Nano-10 PLC supports MODBUS ASCII protocols with the following command and response format:

START	Address	Function	Data	LRC Check	CRLF
:	2 chars	2 chars	# chars	2 chars	2 chars

The following Function Codes are supported:

01/02	Read I/O bit (Use Bit Address Mapping in Table 14.1)
03/04	Read I/O Word registers
05	Force I/O Bit (Use Bit Address Mapping in Table 14.1).
06	Preset Single Word Register
16	Preset Multiple Word Registers

The exact command/response format of the MODBUS protocol can be found at <http://www.modbus.org>. However, if your only purpose is to interface the PLC to other MODBUS hosts such as an LCD touch panel or SCADA software then there is no need to know the underlying protocol command format. All you need to know is which PLC's system Variable is mapped to which MODBUS register, as shown in Table 14.1.

Table 14.1: Memory Mapping of to other PLCs

PLC I/O #		OMRON	MODBUS Word Addr. mapping	MODBUS Bit Addr. Mapping
Input	<b>n</b>			<b>n</b>
	1 to 16	IR00.0 to IR00.15	40001.1 to 40001.16	1 to 16
	17 to 32	IR01.0 to IR01.15	40002.1 to 40002.16	17 to 32
	33 to 48	IR02.0 to IR02.15	40003.1 to 40003.16	33 to 48
	49 to 64	IR03.0 to IR03.15	40004.1 to 40004.16	49 to 64
	65 to 80	IR04.0 to IR04.15	40005.1 to 40005.16	65 to 80
	81 to 96	IR05.0 to IR05.15	40006.1 to 40006.16	81 to 96
Output	<b>n</b>			<b>256 + n</b>
	1 to 16	IR16.0 to IR16.15	40017.1 to 40017.16	257 to 272
	17 to 32	IR17.0 to IR17.15	40018.1 to 40018.16	273 to 288
	33 to 48	IR18.0 to IR18.15	40019.1 to 40019.16	289 to 304
	49 to 64	IR19.0 to IR19.15	40020.1 to 40020.16	305 to 320
	65 to 80	IR20.0 to IR20.15	40021.1 to 40021.16	321 to 336
	81 to 96	IR21.0 to IR21.15	40022.1 to 40022.16	337 to 352
Timer	<b>N</b>			<b>512+n</b>
	1 to 16	IR32.0 to IR32.15	40033.1 to 40033.16	513 to 528
	17 to 32	IR33.0 to IR33.15	40034.1 to 40034.16	529 to 544
	33 to 48	IR34.0 to IR34.15	40035.1 to 40035.16	545 to 560
	49 to 64	IR35.0 to IR35.15	40036.1 to 40036.16	561 to 576
Counter	<b>n</b>			<b>768 + n</b>
	1 to 16	IR48.0 to IR48.15	40049.1 to 40049.16	769 to 784
	17 to 32	IR49.0 to IR49.15	40050.1 to 40050.16	785 to 800
	33 to 48	IR50.0 to IR50.15	40051.1 to 40051.16	801 to 816
	49 to 64	IR51.0 to IR51.15	40052.1 to 40052.16	817 to 832
Relay	<b>n</b>			<b>1024 + n</b>
	1 to 16	IR64.0 to IR64.15	40065.1 to 40065.16	1025 to 1040
	17 to 32	IR65.0 to IR65.15	40066.1 to 40066.16	1041 to 1056
	33 to 48	IR66.0 to IR66.15	40067.1 to 40067.16	1057 to 1072
	49 to 64	IR67.0 to IR67.15	40068.1 to 40068.16	1073 to 1088
	65 to 80	IR68.0 to IR68.15	40069.1 to 40069.16	1089 to 1104
	81 to 96	IR69.0 to IR69.15	40070.1 to 40070.16	1105 to 1120
	97 to 112	IR70.0 to IR70.15	40071.1 to 40071.16	1121 to 1136
	113 to 128	IR71.0 to IR71.15	40072.1 to 40072.16	1137 to 1152
	129 to 144	IR72.0 to IR72.15	40073.1 to 40073.16	1153 to 1168
	145 to 160	IR73.0 to IR73.15	40074.1 to 40074.16	1169 to 1184
	161 to 176	IR74.0 to IR74.15	40075.1 to 40075.16	1185 to 1200
	177 to 192	IR75.0 to IR75.15	40076.1 to 40076.16	1201 to 1216
	193 to 208	IR76.0 to IR76.15	40077.1 to 40077.16	1217 to 1232
	209 to 224	IR77.0 to IR77.15	40078.1 to 40078.16	1233 to 1248
..	..	..	..	
497 to 512	IR96.0 to IR96.15	40097.1 to 40097.16	1521 to 1536	

\* MODBUS is a registered trademark of Groupe Schneider.  
OMRON is a registered trademark of OMRON Corporation.

PLC Variables		OMRON	MODBUS
Timer Present Values	1 to 64	IR128 to IR191	40129 to 40192
Counter Present Values	1 to 64	IR256 to IR319	40257 to 40320
Clock	TIME[1] TIME[2] TIME[3]	IR512 IR513 IR514	40513 40514 40515
Date	DATE[1] DATE[2] DATE[3] DATE[4]	IR516 IR517 IR518 IR519	40517 40518 40519 40520
Variables A to Z (32-bit)  (Firmware >= r79)	A B .... Z	IR714 & IR715 IR715 & IR716 .. IR764 & 765	4-0715 & 4-0716 4-0717 & 4-0718  4-0763 & 4-0764
Data Memory	DM[1] DM[2] .... DM[4000]	DM[1] DM[2] .... DM[4000]	41001 41002 .... 45000

#### 14.6.1.1 BIT ADDRESS MAPPING FROM A MODICON / MODBUS DEVICE

The bit register offset is shown in the last column of Table 14.1. Note that this is the Modicon addressing style, which uses 1-based addressing. When the Modicon variation of the Modbus protocol is used to access the Nano-10 (from software or a master device), the above bit addressing should be used.

When the standard Modbus protocol is used, 0-based addressing is required. This means that the addresses should be one less than indicated in the last column of Table 14.1. Meaning you would use address 0 to access input #1 on the Nano-10 instead of address 1.

All the Nano-10 I/O bits are mapped identically to both the MODBUS “0x” and 1x space. Although MODBUS names the 0x address space as “Coil (which means output bits) and the “1x” address space as “Input Status” (which means input bits only), the Nano-10 PLCs treat both spaces the same. Some MODBUS drivers only allow you to “read” from 0x space and “write” to 1x space but you still use the same offset shown on Table 14.1.

#### Example 1 – Modicon Variation:

To map a lamp symbol to PLC Input 4, you select the MODBUS register address 0-0004. You can also map a lamp symbol to the PLC’s output #2. In that case, you should map it to MODBUS register address 0-0258.

To map a toggle switch symbol to the PLC input #4, if you are restricted to select only MODBUS 1x address space, then you will have to map the switch to 1-0004, and likewise you can map the switch to



output #2 using MODBUS address 1-0258. But if the driver allows the switch to be mapped to 0x space, then you can use MODBUS register space 0-0004 and 0-0258 for the mapping, with identical results.

#### Example 2 – Standard Modbus Variation:

To map a lamp symbol to PLC Input 4, you select the MODBUS register address 0-0003. You can also map a lamp symbol to the PLC's output #2. In that case, you should map it to MODBUS register address 0-0257.

To map a toggle switch symbol to the PLC input #4, if you are restricted to select only MODBUS 1x address space, then you will have to map the switch to 1-0003, and likewise you can map the switch to output #2 using MODBUS address 1-0257. But if the driver allows the switch to be mapped to 0x space, then you can use MODBUS register space 0-0003 and 0-0257 for the mapping, with identical results.

#### 14.6.1.2 WORD ADDRESS MAPPING

As shown in Table 14.1, to access DM[1] from the PLC, you use MODBUS address space 4-1001 and so on. To access the Real Time Clock Hour data (TIME[1]), use 4-0513. The I/O channels can also be read or written as 16-bit words by using the addresses from 4-0001 to 4-0320.

Some MODBUS drivers (such as National Instruments "Lookout" software) even allow you to manipulate individual bit within a 16-bit word. So it is also possible to map individual I/O bits to the "4x" address space. E.g. Input bit #1 can be mapped to 4-0001.1 and output bit #2 is mapped to 4-0257.2, etc. This is how it is shown in Table 14.1. However, if you do not need to manipulate the individual bit then you simply use the address 4-0001 to access the system variable INPUT[1] and address 4-0257 to access the system variable OUTPUT[1]. Note that INPUT[1] and OUTPUT[1] are TBASIC system variables and they each contain 16 bits that reflect the on/off status of the actual physical or internal input and output bits #1 to #16.

### 14.6.2 MODBUS RTU Protocol Support

The Nano-10 PLC also supports the MODBUS RTU protocol. The difference between the ASCII and RTU protocols is that the latter transmits binary data directly instead of converting one byte of binary data into two ASCII characters. A message frame is determined by the silent interval of 3.5 character times between characters received at the COMM port. Other than that, the function codes and memory mappings are identical to the MODBUS ASCII protocol. Table 14.1 therefore applies to the MODBUS RTU protocol as well.

MODBUS RTU has the following command and response format:

Start	Address	Function	Data	CRC 16	END
Silence of 3.5 char times	1 byte	1 byte	# byte	2 bytes	Silence of 3.5 char times

The following Function Codes are supported:

01/02	Read I/O bit (Use Bit Address Mapping in Table 14.1)
03/04	Read I/O Word registers
05	Force I/O Bit (Use Bit Address Mapping in Table 14.1).
06	Preset Single Word Register
16	Preset Multiple Word Registers

### 14.6.3 OMRON Host Link Command Support

Command Type	Header	Level of Support
a) TEST	TS	Full support
b) STATUS READ	MS	Full support
c) ERROR Read	MF	Dummy (always good)
d) IR Area READ	RR	Full support (0000 to 1000)
e) HR, AR, LR Area & TC Status READ	RH	Dummy (always returns "0000")
f) DM AREA READ	RD	Full support
g) PV READ	RC	Dummy (always returns "0000")
h) Status Write	SC	Dummy (always OK)
i) IR Area WRITE	WR	Full Support
j) HR, AR, LR Area & TC Status WRITE	WH, WJ, WL, WG	Dummy (always OK)
k) DM Area WRITE	WD	Full Support (from DM0001-DM4000)
l) FORCED SET	KSCIO KRCIO	Full Support for IR Area only Dummy for other areas.
m) Registered I/O Read for Channel or Bit	QQMR/ QQIR	Full Support for IR and DM only Dummy for other areas (always 0000)

Some OMRON host link commands are described in Section [16.40](#). For other commands please refer to the Omron C20H/C40H PLC Operation manual published by OMRON Corporation. If your purpose is only to use the PLC's OMRON mode with SCADA or HMI, then there is no need to learn the actual command/response format.

### 14.6.4 Application Example: Interfacing to SCADA Software

SCADA software or MMI systems (also known as LCD Touch Panels) normally use an object-oriented programming method. Graphical objects such as switches indicator lights or meters, etc., are picked from the library and then assigned to a certain I/O or internal data address of the PLC. When designing a SCADA system, first you need to define the PLC type. You can choose the MODBUS ASCII, MODBUS RTU or OMRON C20H. Once a graphical object has been created, you will need to edit its connection and at this point you will be presented with a selection table that corresponds to the memory map of that PLC type.

Example 1: To connect an indicator lamp to Input #9 of the PLC.

You will need to program the switch to connect to IR00.8 for the OMRON protocol. However, If you have defined the PLC as MODBUS type, then this indicator lamp should be connected to bit address 1-0265. In either case there is no need to learn about the actual command format of the protocol itself, as the SCADA software will automatically generate the required commands to access the input address that has been chosen for the object.

Example 2: To display readings from ADC #2 as a bar graph on SCADA.

Since the data from ADC #2 is not directly mapped to MODBUS or OMRON in Table 14.1, you need to add a statement in the custom function that reads ADC #2 and copies it into a data memory, e.g.,

```
DM[100] = ADC(2)
```

Now you can program the bar graph on the SCADA screen to be connected to DM[100] if you use the OMRON protocol. For the MODBUS protocol, the object should be connected to the address: 4-1100

## 14.7 Using The PLC As a Modbus Master

### – Getting Data From Power or Flow Meters

The Nano-10 PLC support for the MODBUS protocol goes beyond being a MODBUS slave only. You can use the TBASIC READMODBUS and WRITEMODBUS commands, as well as READMB2 and WRITEMB2 to send out MODBUS ASCII or RTU commands to access any other Nano-10, F-series or T100M+ series PLC or any third party MODBUS slave devices. The READMODBUS or READMB2 commands use MODBUS Function 03 (this can be changed to function 04 using SETSYSTEM 6,4 command) to read from the slave, and WRITEMODBUS or WRITEMB2 use MODBUS Function 16 to write to the slave.

Note that when using the READMODBUS or WRITEMODBUS commands, the 40001 address stated in Table 14.1 should be interpreted as address 0000, and 40002 as address 0001, and 41001 as address 1000, etc. This is in accordance with the specifications stated in MODBUS protocol. MODICON defined zero offset addresses for the MODBUS protocol, yet in their holding register definition these are supposed to start from address 40001 - hence the unusual correspondence. But to maintain compatibility with the MODBUS specifications, we have to adhere to their definitions.

#### 14.7.1 Nano-10 PLC As MODBUS RTU Master

The Nano-10 PLC can also act as a MODBUS RTU master! The same READMODBUS and WRITEMODBUS commands can be used to send and receive MODBUS RTU commands. What you need to do is add 10 (decimal) to the COMM port number to signal to the processor that you wish to use MODBUS RTU instead of MODBUS ASCII to talk to the slaves.

In other words, you should specify port #11 to use RTU commands on COMM1.

E.g. the statement `DM[10] = READMODBUS (11, 8, 16)`

will access, via COMM1, the slave with ID = 08 and read the content of register #16. This register corresponds to MODICON address 40017 and is the OUTPUT[1] of the slave PLC.

The ability to speak MODBUS RTU greatly extends the type of peripherals that can be used with a Nano-10 PLC. You can now make use of many off-the-shelf, third party RTU devices to extend the PLC capability.

## Chapter 15 Host Link Communication Protocol

## 15 HOST LINK PROTOCOL INTRODUCTION

While a Nano-10 PLC is running, it may receive ASCII string commands that read or write to its inputs, outputs, relays, timers, counters, and all the internal variables from a host computer or another Nano-10, F-Series or T100M+ PLC. These ASCII commands are known as the "Host-link commands" and are to be serially transmitted (via RS485 port) to and from the controller. The default serial port settings of the Nano-10 PLC for host-link communication are: *38400 baud, 8 data bit, 1 stop bit, no parity*. The baud rate and the communication format may be changed using the "SetBAUD" TBASIC command described in the i-TRiLOGI Programmer's Reference.

Nano-10 PLC supports the full set of Host Link command protocol found on F-series and M-series PLCs. Hence if you are already familiar with the F or M-series host link protocol the command formats are identical.

---

### 15.1 Multiple Communication Protocols

The Nano-10 PLC, just like the F-series and T100M+ PLCs, supports many different communication protocols to allow maximum application flexibility. In addition to its own native set of communication protocols, the Nano-10 PLC also understands and speaks the following protocols:

- a) \***MODBUS**<sup>™</sup> ASCII mode compatible communication protocol.
- b) \***MODBUS**<sup>™</sup> RTU mode compatible communication protocol.
- c) \***OMRON**<sup>™</sup> Host Link Commands for the C20H PLC family.

\*Note: all trademarks belong to their respective owners.

The native host link command protocol will be described in detail in this and the next chapter. The MODBUS and OMRON compatible protocols have already been discussed in Section 14.7.

---

### 15.2 Native Mode Communication Protocols

When the Nano-10 receives a native host-link command via COMM1, it will automatically send a response string corresponding to the command. This operation is totally transparent to the user and does not need to be handled by the user's program.

All Nano-10 PLCs support both the point-to-point (one-to-one) and multi-point (one-to-many) communication protocols. Each protocol has a different command structure as described below.

---

### 15.3 Point-To-Point Communication Format

In a point-to-point communication system, the host computer's RS485 serial port is connected to the PLC's COMM1. At any one time, only one controller may be connected to the host computer. The host-link commands do not need to specify any controller ID code and are therefore of a simpler format, as shown below:

---

### 15.3.1 Command/Response Frame Format (Point to Point)

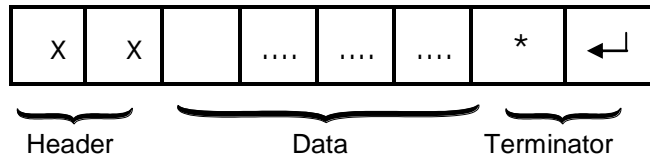

Each command frame starts with a two-byte ASCII character header, followed by a number of ASCII data and ends with a terminator which is comprised of a '\*' character and a carriage return (ASCII value = 13<sub>10</sub>). The header denotes the purpose of the command. For example, RI for Read Input, WO for Write Output, etc. The data is usually the hexadecimal representation of numeric data. Each byte of binary data is represented by two ASCII characters (00 to FF).

To begin a communication session, the host computer must first send one byte of ASCII character: Ctrl-E (=05Hex) via its serial port to the controller. This informs the controller that the host computer wishes to send a (point-to-point) host-link command to it. Thereafter, the host computer must wait to receive an echo of the Ctrl-E character from the controller. Reception of the echoed Ctrl-E character indicates that the controller is ready to respond to the command from the host computer. At this moment, the host computer must immediately send the *command frame* to the controller and then wait to receive the *response frame* from the controller. The entire communication session is depicted in Figure 15.1.

After the controller has received the command, it will send a response frame back to the host computer and this completes the communication session. If the controller accepts the command, the response frame will start with the same header as the command, followed by the information that has been requested by the command and the terminator.

As you can probably see, proper handshaking using the Ctrl-E character between the host and the PLC is important to communicate successfully using the Point-to-point protocol.

Although the "Multi-point" format discussed in the next section seems more complex, the communication exchange using multi-point protocol is actually simpler than point-to-point since it involves only a single exchange of command/response string. We therefore recommend using the multi-point format if you are writing your own communication program.

Note: TBASIC has a built-in command "NETCMD\$" that lets a Nano-10 PLC access another slave PLC using the multipoint Host-link protocol format very easily.

If an unknown command is received or if the command is illegal (such as access to an unavailable output or relay channel), the following **error response** will be received:

### 15.3.2 Error Response Format

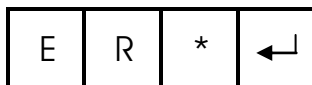

The host computer program should always check the returned response for possibilities of errors in the command and take necessary actions.

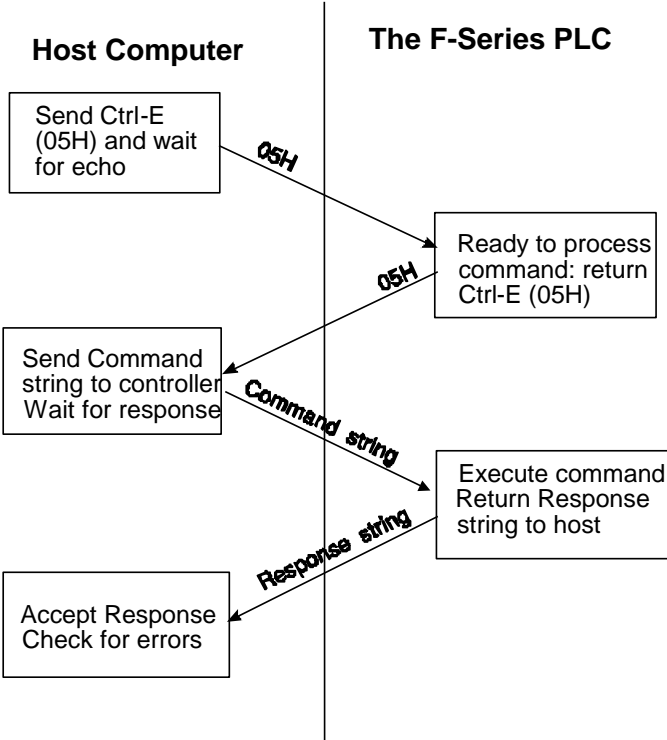
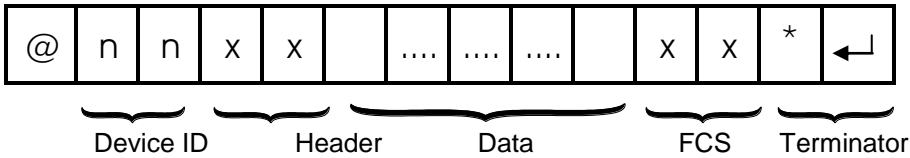

Figure 15.1

## 15.4 MULTI-POINT COMMUNICATION SYSTEM

In this system, one host computer may be connected to either a single PLC (via RS485) or multiple PLCs on an RS485 network.

### 15.4.1 Command/Response Frame Format (Multi-point)



Each command frame starts with the character "@" and two-byte hexadecimal representation of the controller's ID (00 to FF), and ends with a two-byte "Frame Check Sequence" (FCS) and the terminator. FCS is provided for detecting communication errors in the serial bit-stream. If desired, the command frame may omit calculating the FCS simply by putting the characters "00" in place of the FCS.

**Note:** we call "00" the "wildcard" FCS, which is available when the PLC is in "auto protocol" mode. This is to facilitate easy testing of the multi-point protocol. However, the wildcard FCS can be disabled if the PLC has executed the `SETPROTOCOL n, 5` to put its COMM port `n` into pure native mode. In that case you will have to supply the actual FCS to your command string.



### 15.4.2 Calculation of FCS

The FCS is 8-bit data represented by two ASCII characters (00 to FF). It is a result of performing an Exclusive OR on each character in the frame sequentially, starting from @ in the device number to the last character in the data. An example is as follows :

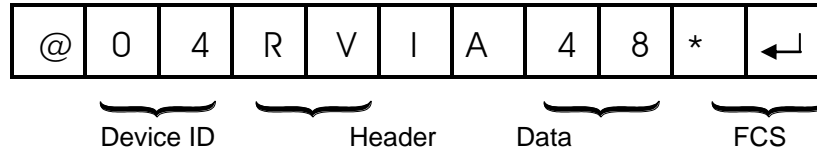

@	0100 0000
	XOR
0	0011 0000
	XOR
4	0011 0100
	XOR
R	0101 0010
	XOR
V	0101 0110
	XOR
I	0100 1001
	XOR
A	0100 0001

---

0100 1000 = 48<sub>16</sub>

Value 48<sub>16</sub> is then converted to ASCII characters '4' (0011 0100) and '8' (0011 1000) and placed in the FCS field.

#### FCS calculation program example

The following C function will compute and return the FCS for the "string" passed to it.

```
unsigned char compute_FCS(unsigned char *string){
    unsigned char result;
    result = *string++;      /*first byte of string*/
    while (*string)
        result ^= *string++; /* XOR operation */
    return (result);
}
```

A **Visual Basic** routine for FCS computation is included in the source code of a sample communication program you can download from:

<http://www.tri-plc.com/applications/VBsample.htm#VB6sample>

### 15.4.3 Communication Procedure

Unlike the point-to-point communication protocol, the host computer must **NOT** send the CTRL-E character before sending the command frame. After the host computer has sent out the multi-point host-link command frame, only the controller with the correct device ID will respond. Hence it is essential to ensure that every controller on the RS485 network assumes a different ID (If a master PLC is used, then

the master PLC should also have a different ID from all the slaves). Otherwise, contention may occur (i.e., two controllers simultaneously sending data on the receiver bus, resulting in garbage data being received by the host). On the other hand, if none of the controller IDs match that specified in the command frame, then the host computer will receive no response at all.

The PLC automatically recognizes the type of command protocols (point-to-point or multi-point) sent by the host computer and it will respond accordingly. If a multi-point command is accepted by the controller, the response frame will start with a character '@', followed by its device ID and the same header as the command. This will be followed by the data requested by the command, a response frame FCS and the terminator.

#### 15.4.4 Framing Errors

When the controller receives a multi-point host-link command frame, it computes the FCS of the command and compares it with the FCS field received in the command frame. If the two do not match, then a "framing error" has occurred. The controller will send the following Framing Error Response to the host:

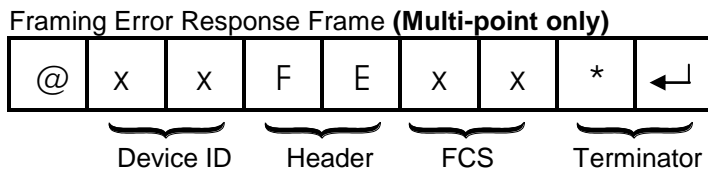

#### 15.4.5 Command Errors

If an unknown command is received or if the command is illegal (such as an attempt to access an unavailable channel), the following **error response** will be received:

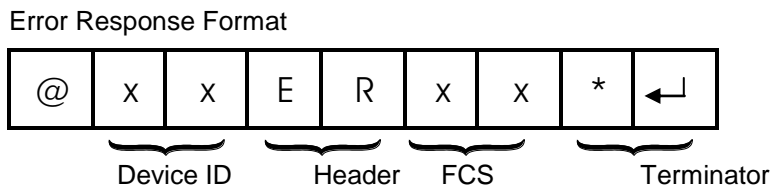

The host computer program should always check the returned response for possibilities of errors in the command and take necessary action.

#### 15.4.6 SHOULD YOU USE POINT-TO-POINT OR MULTI-POINT PROTOCOL?

Although at first the point-to-point protocol appears simpler in format (having no ID and no FCS computation), the communication procedure is actually more complex since it involves the need to synchronize the two communicating devices by exchanging the Control-E character. The lack of error checking also makes the protocol less reliable especially in noisy environment.

In fact, the TLServer software will only accept multi-point communication protocol from the client software with the exception of the "IR\*" command, which is needed to obtain the ID of a PLC with unknown ID. Hence, if you were to write your own communication program to talk to the PLCs, we would strongly recommend using only the multi-point protocol exclusively due to its simplicity and built-in error checking capability.

## 15.5 RS485 Primer

### 15.5.1 RS485 Network Interface Hardware

The built-in RS-485 interface allows the Nano-10 PLC to be networked together using very low cost twisted-pair cables. Since the Nano-10 PLCs are fitted with a 1/8-power RS485 driver such as the 75HVD3082, up to 256 devices can be connected together. The twisted-pair cable goes from node to node in a daisy chain fashion and should be terminated by a 120-ohm resistor as shown below.

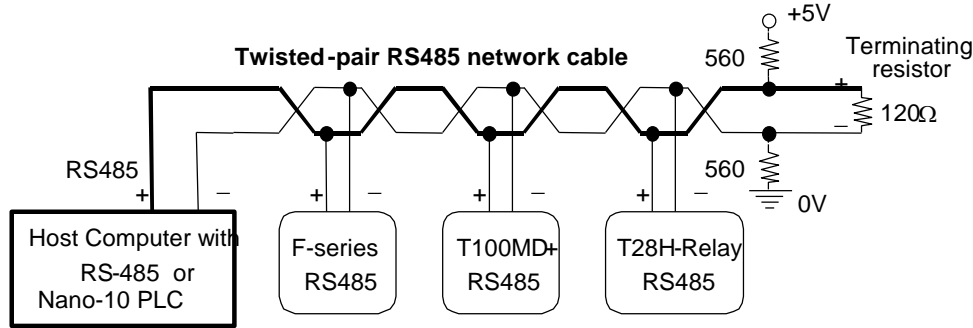

Figure 15.2

Note that the two wires are not interchangeable so they must be wired the same way to each controller. The maximum wire length should not be more than 1200 meters (4000 feet). RS-485 uses balanced or differential drivers and receivers, which means that the logic state of the transmitted signal depends on the differential voltage between the two wires and not on the voltage with respect to a common ground.

As there will be times when no transmitters are active (which leaves the wires in "floating" state), it is good practice to ensure that the RS-485 receivers will indicate to the CPUs that there is no data to receive. In order to do this, we should hold the twisted pair in the logic '1' state by applying a differential bias to the lines using a pair of 560Ω to 1KΩ biasing resistors connected to a +9V (at least +5V) and 0V supply as shown in Figure 15.2. Otherwise, random noise on the pair could be falsely interpreted as data.

The two biasing resistors are necessary to ensure robust data communication in actual applications. Some RS485 converters may already have biasing built-in so the biasing resistors may not be needed. However, if the master is an F-series, M-series or Nano PLC then you should use the biasing resistor to fix the logic states to a known state. Although in a lab environment the PLCs may be able to communicate without the biasing resistors, their use is strongly recommended for industrial applications.

### 15.5.2 Protection of RS485 Interface

The simple, direct multi-drop wiring shown in Figure 15.2 will work well if all the networked PLCs are in close proximity and they all share a common power supply. They will even work for long distance as long as there are no wiring errors. However, in an industrial environment, the PLCs are most likely far apart and may each have their own power supply. Since processes are often modified regularly, should somebody on one occasion by mistake short one of the PLC's RS485 to high voltage, all the PLCs connected to the same RS485 wiring will be fried simultaneously. This can result in very costly down time for the whole process because all of the PLCs connected to the network will need to be repaired.

Hence, for networking over long distances and involving more than a few PLCs, it is important to either strengthen or protect the RS485 interface, as described below:

1. You can replace the standard RS485 driver (75HVD3082) on the PLC with a fault-tolerant RS485 driver IC; part number LT1785AIN8. This 8 pin IC is made by Linear Technology and can

withstand wrong voltages of up to  $\pm 60V$ ! The LT1785AIN8 is a 1/4 power RS485 driver, which means up to 128 PLCs can be connected together.

Unfortunately this IC is much more expensive than 75HVD3082 and hence it is not provided as standard component on the PLC. You can purchase the IC from any major electronic catalog company such as [www.digikey.com](http://www.digikey.com).

- When using non fault-tolerant RS485 drivers such as SN75176 or SN75HVD3082, we strongly recommend the following protection circuit to be added between every PLC's RS485 and the twisted pair multi-drop network cable:

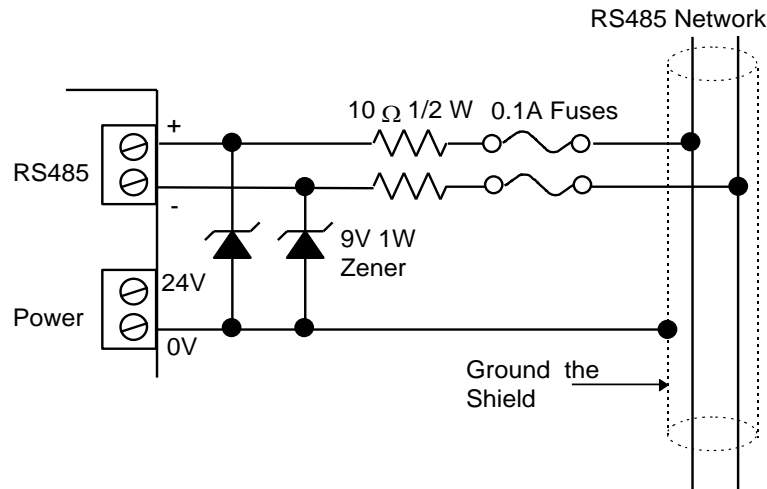

Figure 15.3

**Note:**

As can be seen from the circuit, the two 9V Zener diodes clamp the signal voltage on the PLC's RS485 interface to between +9V and -0.7V. If the high voltage persists, the 0.1A fuse will blow, effectively disconnecting the PLC from the offending voltage on the network.

Even if you choose to replace the RS485 driver by an LT1785AIN8 IC instead of using the zener/fuse pair wiring, you should still use shielded twisted pair cables as the multi-drop network "backbone" and connect the shield to the 0V (DC ground) power terminal of every PLC. The grounded shield then provides a common ground reference for all the different PLCs' power supplies. Even though the RS485 network may still work without a common ground reference because the signal wire pair will somehow "pull" all the RS485 devices to some reference point. Failure to provide a common ground is a potential source of serious trouble as signal wires with a floating ground easily induce large voltage differences between nodes when subjected to electromagnetic interference. Hence, for reliable operation it is important to provide the common ground. A grounded shield also has the additional advantage of shielding the electrical signals from EMI.

### 15.5.3 Single Master RS485 Networking Fundamentals

RS485 is a half-duplex network, i.e., the same two wires are used for both transmission of the command and reception of the response. Of course, at any one time, only one transmitter may be active. The Nano-10 PLC implements a master/slave network protocol. The network requires a master controller, which is typically a PC equipped with an RS485 interface. In the case of a PC, you can purchase an RS-485 adapter or an RS232C-to-RS485 converter and connect it to the RS232C serial port. Any F-series, M-series, or even the Nano-10 PLC can be programmed to act as the master, it can communicate with other PLCs by executing the "NETCMD\$" function or the "READMODBUS" or the "WRITEMODBUS"

commands (the latter two are for communicating using MODBUS protocols only and are covered in [Section 14.8](#)).

Only the master can issue commands to the slave PLCs. To transmit a command, the master controller must first enable its RS-485 transmitter and then send a multi-point command to the network of controllers. After the last stop bit has been sent, the master controller must relinquish the RS485 bus by disabling its RS485 transmitter and enabling its receiver. At this point the master will wait for a response from the slave controller that is being addressed. Since the command contains the ID of the target controller, only the controller with the correct ID would respond to the command by sending back a response string. For the network to function properly, it is obvious that no two nodes can have the same ID. You can use the "Setup Serial Port" command in TLServer to set the ID for each PLC on the node. You can also use the "IW" Host Link command to set the device ID. Also, all nodes must be configured to the same baud rate and communication format.

Care should be taken to ensure that the power supplies for all the controllers are properly isolated from the main so that no large ground potential differences exist between any controllers on the network.

### 15.5.4 Multi-Master (Peer-to-Peer) RS485 Networking Fundamentals

The built-in Ethernet port of Nano-10 PLC inherently supports multi-master, peer-to-peer network connection without any arbitration. Therefore if there is a need to perform peer-to-peer networking, it will be much easier to do it via the Ethernet port. However, if the Nano-10 is not connected to LAN or a low cost local networking solution via RS485 is desired, then the following discussion will be relevant.

Since any F, M or Nano PLC is capable of sending out network commands, the obvious question is whether multiple masters are allowed on the RS485 network? It is possible to have multiple masters on a single RS485 network provided the issues of collision and arbitration are taken care of. There are several means to achieve these objectives.

#### 15.5.4.1 *Multiple Access with Collision Detection*

There is nothing to stop any PLC from sending out host-link commands to other PLCs. However, if more than one PLC simultaneously enables their transmitters and send out host-link commands, then the signals will conflict and the messages will be garbled up. If the network traffic is low, then the solution may be a matter of having the master check for the correct response after sending out a command string. If there is error in the response string, the master should back off the network for a short while (use different timing for different PLCs) and then re-send the command until a correct response string is obtained.

Fortunately, the "NETCMD\$" function of these PLCs always checks the integrity of the response string for correct FCS (Frame Check Sequence) characters before returning the string (Please refer to the Programmer's Reference for detail description of the NETCMD\$( ) function).

However, the program must still check the following items in the response string to verify that the string returned from NETCMD\$( ) function indeed comes from the PLC that it had talked to and not from another PLC (which tries to send a command to someone else):

- i) The ID is correct
- ii) The header is identical to the command string
- iii) The length of response string is correct.

*Pros and Cons:* This method does not incur any hardware cost, but it requires careful programming and strict checking of the response string and hence requires more effort to program. It is also the least desirable if the network traffic is moderately high as many collisions will occur and there is danger of some undetected error being allowed to pass through.

#### 15.5.4.2 Token Awarding Scheme

A “token” is a software means of telling a PLC that it has been given the right to temporarily act as the master. A Nano-10 PLC or a host PC can serve as the token master. An internal relay bit or a variable of the PLC can be defined as the token. The token master will begin by giving the token (i.e., by setting the token relay bit to ‘1’ or the token variable to some fixed value) to the first PLC on the list. The PLC that has the token can then send host-link commands to other PLCs. When it has finished the job it can then send a command to the token master to relinquish its token. If it is based on a fixed timing scheme the master can assume that the PLC will complete its job after a fixed time (say 0.1 seconds) and turn off its corresponding token relay bit.

The token master then passes the token to the next PLC on the list and so on until the last PLC has relinquished its token, and the token is passed back to the first PLC on the list again. This way at any one time there will only be one active network master (the one with the token) and hence there is no danger of conflicting signals or garbled messages to handle.

Pros and Cons: This method also does not incur any hardware cost, but it requires the programmer to draw up a plan on what internal relay or variable to use as the token and how the PLC can relinquish its token to the token master. (It could be by fixed timing or by returning a message to relinquish the token) It is a challenging job for programmers unfamiliar with networking schemes, but with some experimentation it can be achieved readily.

#### 15.5.4.3 Rotating Master Signal

In this scheme we make use of the digital inputs of the PLC to grant the PLC the right to act as the network master. Lets call this input the “Be the Master” input. We can use a low cost H-series PLC running a sequencer to activate the “Be the Master” input line of each PLC one at a time. Each PLC is given a fixed amount of time to be the master (e.g. 0.1s each). Only when the “Be the Master” input is ON can the new master PLC start sending out host-link commands to other PLCs. So at any one time there will only be one master on the network and no conflict will occur as a result.

Pros and Cons: This method is the easiest to program since there is no need to handle the token with the token master or perform extensive error check on the response string. However, this method uses one input of each PLC and as many outputs on the master-signal generator PLC as there are PLC masters. It also requires wiring the PLCs to the master-signal generator PLC.

### 15.5.5 TROUBLE-SHOOTING AN RS485 NETWORK

#### 1) Single faulty device

If a single device on the RS485 network becomes inaccessible, problems can be isolated to this particular device. Check for loose or broken wiring or wrong DIP switch settings. Also double check the device ID using the host-link command "IR\*" sent via the RS232C port of the PLC. If all attempts fail, either replace the entire PLC or the 75HVD3082 chip that handles the RS485 interfacing and try again.

#### 2) Multiple faulty devices

If all the PLCs are inaccessible by the host computer, it may possibly be due to a faulty RS232C-to-RS485 converter at the host computer. If this is the case, disconnect the RS485 converter from the network and check it using a single PLC. Replace the converter if it is confirmed to be faulty. Next check the wire from the converter to the beginning of the network. A broken wire here can lead to the failure of the entire network.

Since an RS485 network links many PLCs together electrically and in a daisy chain fashion, problems occurring along the RS485 network sometimes affect the operation of the entire network. For example, a broken wire at the terminal of one node may mean that all the PLCs connected after this node become

inaccessible by the master. If the RS485 interface of one of the PLCs has short-circuited because of component failure, then the entire network goes down with it too. This is because no other node is able to assert proper signals on the two wires that are also common to the shorted device.

Hence, when trouble-shooting a faulty RS485 network, it may be necessary to isolate all the PLCs from the network. Thereafter, reconnect one PLC at a time to the network, starting from the node nearest to the host computer. Use the TRiLOGI program to check communication with each PLC until the faulty unit has been identified.

## Chapter 16 Host Link Protocol Format



## 16 HOST LINK PROTOCOL FORMAT

This chapter describes the detailed formats of the command and response frames for Nano-10 PLC host link commands. Only the formats for the point-to-point communication protocol are presented, but all these commands are available to the multi-point protocol as well.

To use a command for multi-point system, simply add the device ID (@nn) before the command header and the FCS at the end of the data (See Chapter 3 for detailed descriptions of multi-point communication command format).

### 16.1 Device ID Read

#### Command Format

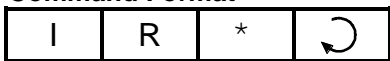

#### Response Format

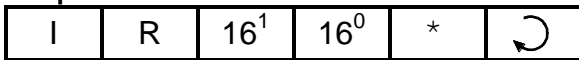

Device ID (00 to FF)

The device ID is to be used for the multi-point communication protocol so that the host computer can selectively communicate with any controller connected to a common RS485 bus (see Chapter 3 for details). The ID has no effect for point-to-point communication. The device ID is stored in the PLC's non-volatile memory and, therefore, will remain with the controller until it is next changed.

### 16.2 Device ID Write

#### Command Format

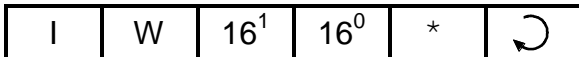

New Device ID (00 to FF)

#### Response Format



E.g. To set the PLC's ID to 0A, send command string "IW0A\*" to PLC.

### 16.3 Read Digital Input Channels

#### Command Format

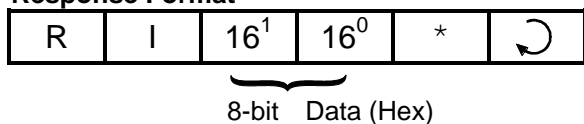

8-bit Channel # (Hex)

**Response Format****16.3.1 Definition of Input Channels**

The following table shows the input numbers as defined in TRILOGI's Input entry table corresponding to the input channel number.

	Bit7	Input/Output Numbers						Bit0
CH00:	8	7	6	5	4	3	2	1
CH01:	16	15	14	13	12	11	10	9
CH02:	24	23	22	21	20	19	18	17
CH03:	32	31	30	29	28	27	26	25
CH04:	40	39	38	37	36	35	34	33
CH05:	48	57	56	45	44	43	42	41
CH06:	56	55	54	53	52	51	50	49
CH07:	64	63	62	61	60	59	58	57
CH08:	72	71	70	69	68	67	66	65
CH09:	80	79	78	77	76	75	74	73
CH0A <sub>16</sub> :	88	87	86	85	84	83	82	81
CH0B <sub>16</sub> :	96	95	94	93	92	91	90	89
CH0C <sub>16</sub> :	104	103	102	101	100	99	98	97
....	..	..	..	..	..	..	..	..
CH1E <sub>16</sub> :	248	247	246	245	244	243	242	241
CH1F <sub>16</sub> :	256	255	254	253	252	251	250	249

The 8-bit inputs of each channel are represented by a two byte ASCII text expression of its hexadecimal value. For example: if inputs 1 to 3 are logic '0's, inputs 4 to 10 are logic '1's and all other inputs are logic '0's, then if you send command "RI00\*", you will get the response "RIF8\*" ( $F8_{16} = 1111\ 1000_2$ ).

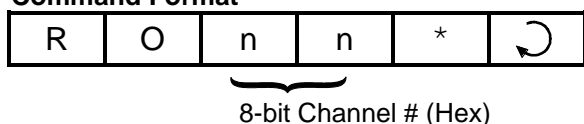
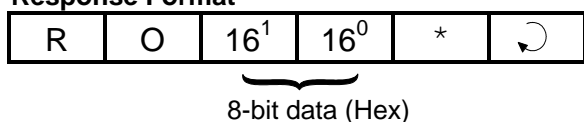
**16.4 Read Digital Output Channels****Command Format****Response Format**

Please refer to the Input/Output vs Channel Number table described in the section “16.3. Read Digital Input Channels” for details.

### 16.5 Read Internal Relay Channels

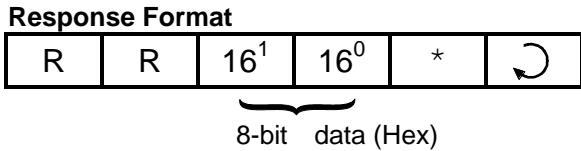
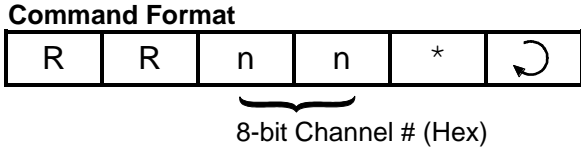

#### 16.5.1 Definition of Internal Relay Channel Numbers

Nano-10 supports 512 internal relays, the channel definition of the first 256 internal relays is the same as the inputs and the outputs. The remaining relays and their assigned channels are shown in the following table:

	Relay numbers							
	bit7							bit0
CH20 <sub>16</sub> :	264	263	262	261	260	259	258	257
CH21 <sub>16</sub> :	272	271	270	269	268	267	266	265
CH22 <sub>16</sub> :	280	279	278	277	276	275	274	273
CH23 <sub>16</sub> :	288	287	286	285	284	283	282	281
CH24 <sub>16</sub> :	296	295	294	293	292	291	290	289
CH25 <sub>16</sub> :	304	303	302	301	300	299	298	297
CH26 <sub>16</sub> :	312	311	310	309	308	307	306	305
CH27 <sub>16</sub> :	320	319	318	317	316	315	314	313
CH28 <sub>16</sub> :	328	327	326	325	324	323	322	321
CH29 <sub>16</sub> :	336	335	334	333	332	331	330	329
CH2A <sub>16</sub> :	344	343	342	341	340	339	338	337
CH2B <sub>16</sub> :	352	351	350	349	348	347	346	345
..	..	..	..	..	..	..	..	..
CH3A <sub>16</sub> :	488	487	486	485	484	483	482	481
CH3D <sub>16</sub> :	496	495	494	493	492	491	490	489
CH3E <sub>16</sub> :	504	503	502	501	500	499	498	497
CH3F <sub>16</sub> :	512	511	510	509	508	507	506	505

## 16.6 Read Timer Contacts

### Command Format

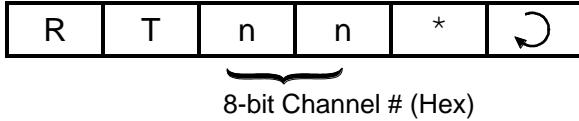

### Response Format

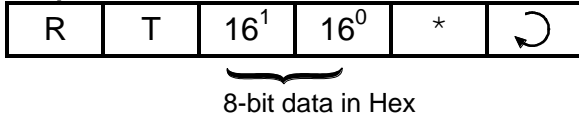

### 16.6.1 Definition of Timer-Contact Channel Numbers

A timer contact is a single bit of memory and 8 timer contacts are grouped into one 8-bit channel similar to that of the inputs, outputs etc.

The following table shows the timer numbers defined in TRiLOGI's Timer entry table and their corresponding channel numbers.

	Timer Contact numbers							
	bit7							bit0
CH0:	8	7	6	5	4	3	2	1
CH1:	16	15	14	13	12	11	10	9
CH2:	24	23	22	21	20	19	18	17
CH3:	32	31	30	29	28	27	26	25
CH4:	40	39	38	37	36	35	34	33
CH5:	48	57	56	45	44	43	42	41
CH6:	56	55	54	53	52	51	50	49
CH7:	64	63	62	61	60	59	58	57

## 16.7 Read Counter Contacts

### Command Format

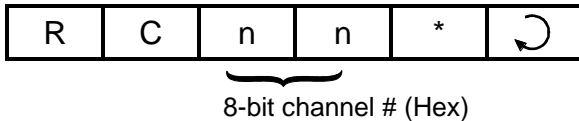

### Response Format

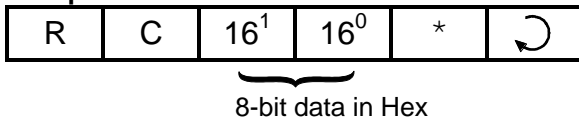

### 16.7.1 Definition of Counter-Contact Channel Numbers:

The 64 counter contacts are assigned channel #'s in exactly the same way as the 64 timers. Please refer to the last section: "16.6. Read Timer Contacts" for details.

## 16.8 Read Timer Present Value (P.V.)

### Command Format



nn: Timer1=00, ..... Timer16=0F.... Timer64=3F

### Response Format

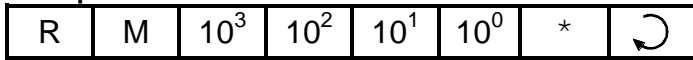

Timer present value in Decimal

The present value (PV) of the specified timer is returned in decimal form as four byte ASCII text characters from 0000 to 9999.

## 16.9 Read Timer Set Value (S.V.)

### Command Format



nn: Timer1=00, ..... Timer16=0F.... Timer64=3F

### Response Format

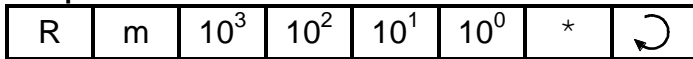

Timer Set Value in Decimal

The Set Value (S.V.) of the specified timer is returned in decimal form as four byte ASCII text characters from 0000 to 9999. Note that this command header contains **small letter “m”** instead of “M” in the “RM” command.

## 16.10 Read Counter Present Value (P.V.)

### Command Format



nn: Counter1=00, ..... Counter16=0F.... Counter64=3F

### Response Format

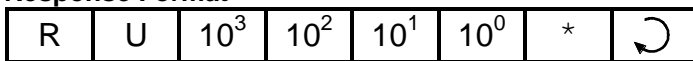

Counter present value in Decimal

The Present Value of the specified counter is returned in decimal form as four byte ASCII text characters from 0000 to 9999.

### 16.11 Read Counter Set Value (S.V.)

**Command Format**



nn: Counter1=00, ..... Counter16=0F.... Counter64=3F

**Response Format**

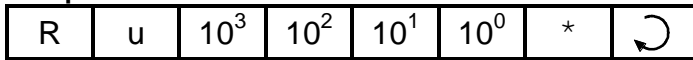

Counter Set Value in Decimal

The Set Value of the specified counter is returned in decimal form as four byte ASCII text characters from 0000 to 9999. Note that this header contains **small letter “u”** instead of “U” in the “RU” command.

### 16.12 Read Variable - Integers (A to Z)

**Command Format**

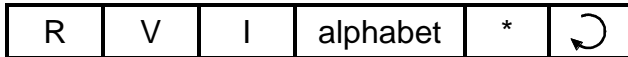

A,B,C....Z

**Response Format**

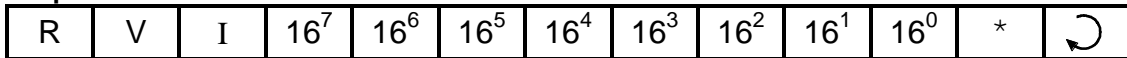

8 Hexadecimal Digit for 32-bit integer

E.g. To read the value of the variable “K”, send host-link command “RVIK\*”. If variable K contains the value  $123456_{10}$  ( $=1E240_{16}$ ), the PLC will send the response string as “RVI0001E240\*”.

### 16.13 Read Variable - Strings (A\$ to Z\$)

**Command Format**

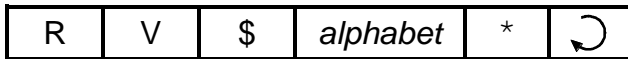

A,B,C....Z

**Response Format**

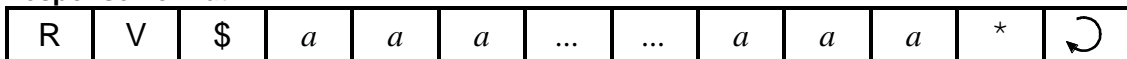

ASCII characters of the string (variable length)

E.g. To read the value of the string variable “M\$”, send host-link command “RV\$M\*”. If variable M\$ contains the string “Hello World”, the PLC will send the response string as “RV\$Hello World\*”.

### 16.14 Read Variable - Data Memory (DM[1] to DM[4000])

**Command Format**

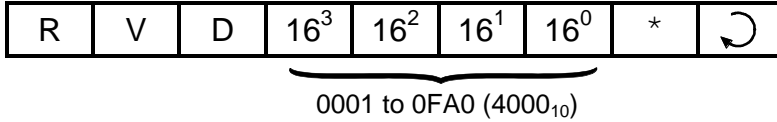

**Response Format**

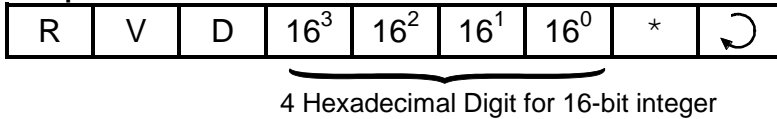

E.g. To read the value of DM[3600], send host-link command “RVD0E10\*”. If variable DM[3600] contains the value 12345<sub>10</sub> (=3039<sub>16</sub>), PLC will send the response string as “RVD3039\*”.

### 16.15 Read Variable - System Variables

This command allows you to read all the Nano-10 PLC’s 16-bit system variables such as the inputs[ ], outputs[ ], relays[ ], counters[ ], timers[ ], timers’ P.V., counters’ P.V., CLK[ ] and DATE[ ]. Although inputs, outputs etc. are also accessible via the “RI”, “RO”, “RR”... commands, the RVS command can access them as 16-bit words instead of as 8-bit bytes in those commands. For the 32-bit system variable HSCPV[ ], use the “RVH” command described in the next section to access it. It may be more conventional for some SCADA software driver to use a single header command “RVS” to access all the I/O, varying only the “type” number to access different I/O types.

The RVS command also can be used to access the internal variables used to store ADC, DAC and PWM values obtained during the latest execution of the ADC(), setDAC or setPWM statement. These are however not system variables in the TBASIC sense. E.g. it is illegal to use ADC[2] to access the ADC channel #2 in TBASIC (you have to use the ADC(2) function instead). An 8-bit hexadecimal number is used to denote the “type” of system variable, as shown in the following table:

System Variable	type
input[ ]	01
output[ ]	02
relay[ ]	03
timer[ ]	04
ctr[ ]	05
timerPV[ ]	06
ctrPV[ ]	07

System Variable	type
clk[ ]	08
date[ ]	09
-	0A
ADC*	0B
DAC*	0C
PWM*	0D

\*Not a system variable in TBASIC, but readable.

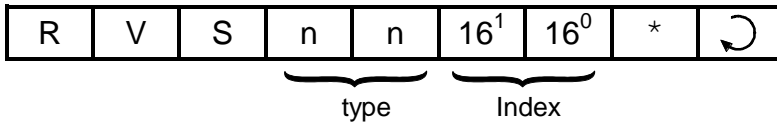
**Command Format**

**type** (01 to 0D) - denotes the type of system variable to access,  
**index** (01 to 1F) - index into the array, starting from 01.

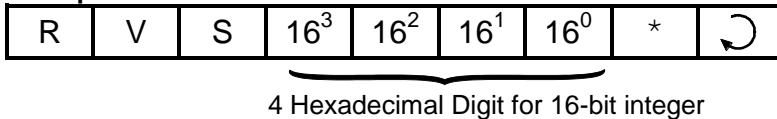
**Response Format**

Example: To read the value of DATE[2] (which represents the month of the RTC), send command "RVS0902\*" and if the PLC responds with "RVS0005", it means the month is May.

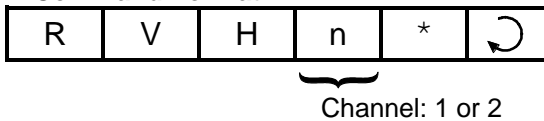
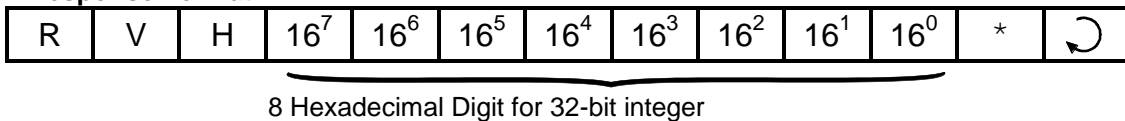
**16.16 Read Variable - High Speed Counter HSCP[ ]****Command Format****Response Format**

E.g. To read the value of HSCP[2], send hostlink command "RVH2\*". If variable HSCP[2] contains the value  $123456_{10}$  ( $=1E240_{16}$ ), the PLC will send the response string as "RVH0001E240\*".

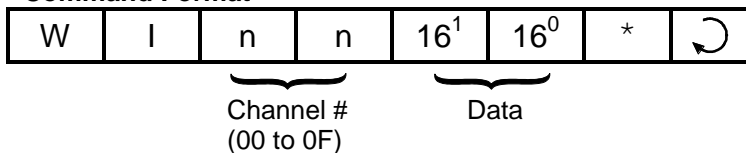
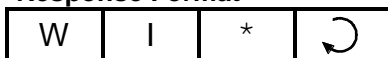
**16.17 Write Inputs****Command Format****Response Format**



## 16.18 Write Outputs

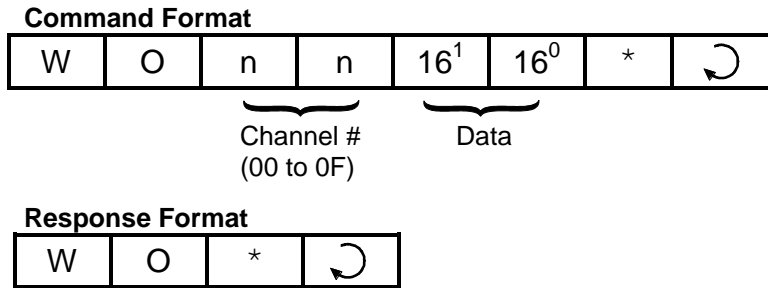

## 16.19 Write Relays

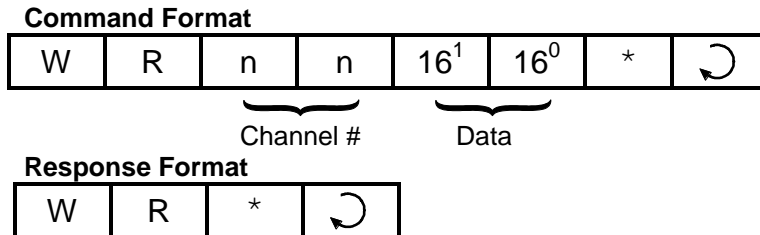

## 16.20 Write Timer-contacts

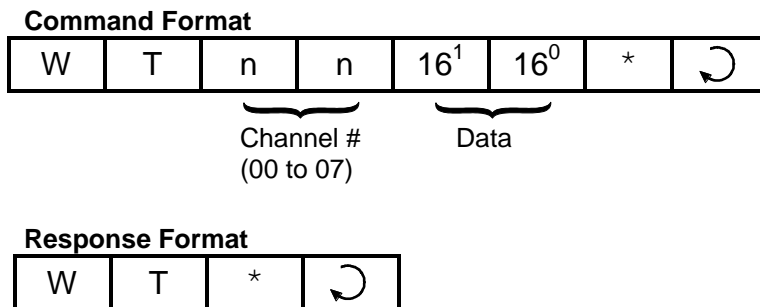

## 16.21 Write Counter-contacts

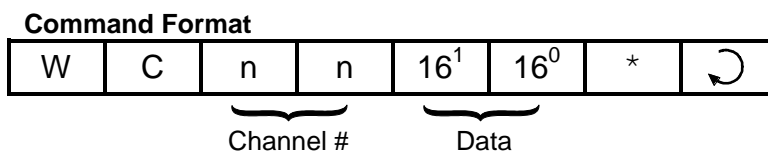

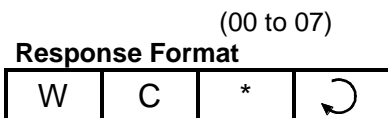

## 16.22 Write Timer Present Value (P.V.)

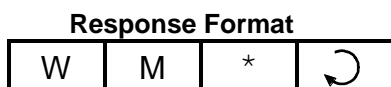
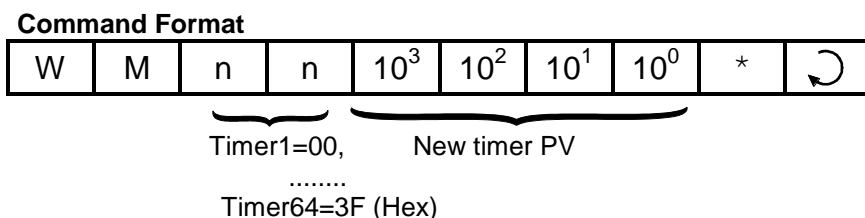

Please note that the timer number starts from 00, which represent timer #1, then 01 represents timer #2. and so on.

## 16.23 Write Timer Set Value (S.V.)

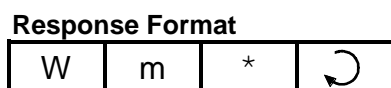
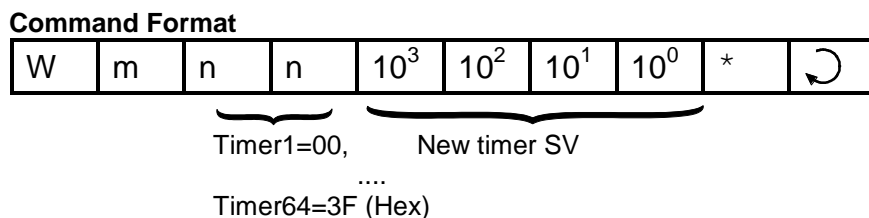

**Note:** the 2nd character is a lower case “m” instead of the upper case “M” of “WM” command.

## 16.24 Write Counter Present Value (P.V.)

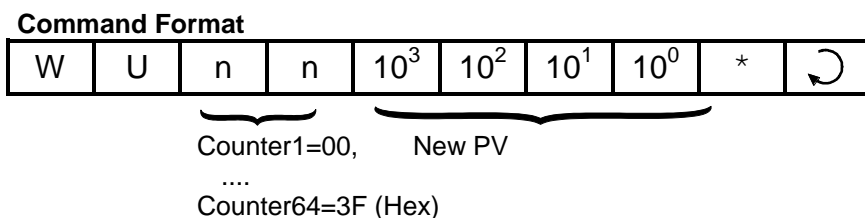

**Response Format**

W	U	*	↻
---	---	---	---

**16.25 Write Counter Set Value (S.V.)****Command Format**

W	u	n	n	$10^3$	$10^2$	$10^1$	$10^0$	*	↻
---	---	---	---	--------	--------	--------	--------	---	---

Counter1=00,    New Counter SV

....  
Counter64=3F (Hex)

**Response Format**

W	u	*	↻
---	---	---	---

**Note:** the 2nd character is a lower case “u” instead of the upper case “U” of the “WU” command.

**16.26 Write Variable - Integers (A to Z)****Command Format**

W	V	I	<i>alphabet</i>	$16^7$	$16^6$	$16^5$	$16^4$	$16^3$	$16^2$	$16^1$	$16^0$	*	↻
---	---	---	-----------------	--------	--------	--------	--------	--------	--------	--------	--------	---	---

A,B,C....Z    8 Hexadecimal Digit for 32-bit integer

**Response Format**

W	V	I	*	↻
---	---	---	---	---

E.g. To assign variable “K” to number  $56789_{10}(=0DD5_{16})$ , send hostlink command “WVIK00000DD5\*”.

**16.27 Write Variable - Strings (A\$ to Z\$)****Command Format**

W	V	\$	<i>alphabet</i>	<i>a</i>	<i>a</i>	...	...	<i>a</i>	<i>a</i>	*	↻
---	---	----	-----------------	----------	----------	-----	-----	----------	----------	---	---

A,B,C....Z    ASCII characters of the  
string (variable length)

**Response Format**

W	V	\$	*	↻
---	---	----	---	---

E.g. To assign the string " Super PLC" to the string variable P\$, send hostlink command "wv\$P Super PLC\*".

### 16.28 Write Variable - Data Memory (DM[1] to DM[4000])

**Command Format**

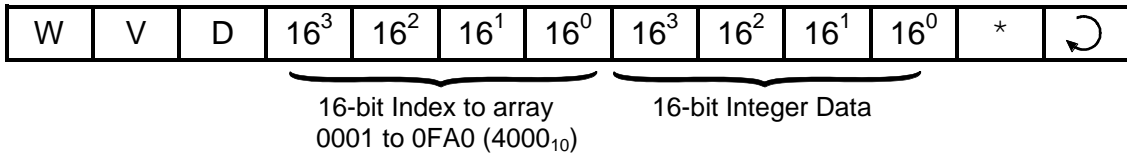

**Response Format**



E.g. To write the value 1234<sub>10</sub> (=4D2<sub>16</sub>)to DM[1000], send hostlink command "wVD03E804D2\*". (1000<sub>10</sub> = 3E8<sub>16</sub>)

### 16.29 Write Variable - System Variables

System Variable	type
input[ ]	01
output[ ]	02
relay[ ]	03
timer[ ]	04
ctr[ ]	05
timerPV[ ]	06
ctrPV[ ]	07

System Variable	type
clk[ ]	08
date[ ]	09
-	0A
ADC*	0B
DAC*	0C
PWM*	0D

\*Not a system variable in TBASIC

**Command Format**

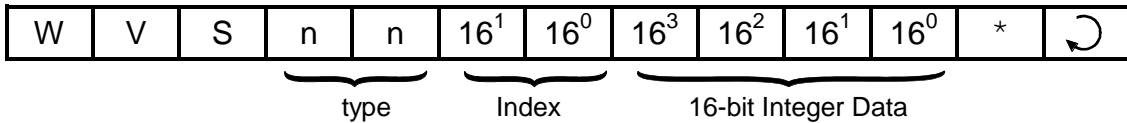

**type** (01 to 0D) - denotes the type of system variable to access,  
**index** (01 to 1F) - index into the array, starting from 01.

**Response Format**

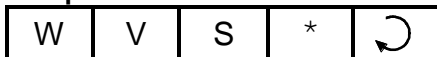

E.g. To set clk[1] (which represents the hour of the RTC) to 14, send the command "wVS0801000E\*" to the PLC.

### 16.30 Write Variable - High Speed Counter HSCPV[ ]

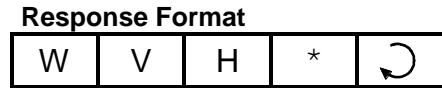
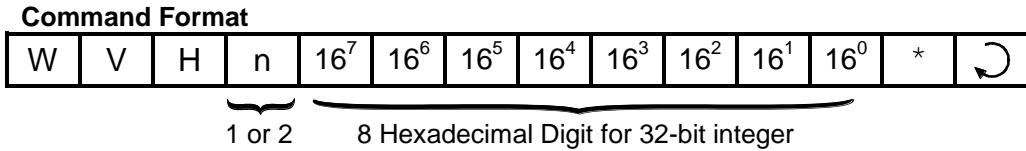

E.g. To clear the value of HSCPV[2], send hostlink command "wvH200000000\*".

### 16.31 Halting the PLC

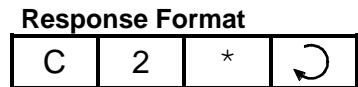
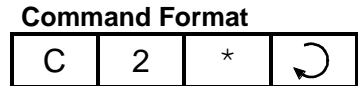

When the PLC receives this command, it temporarily halts the execution of the PLC's ladder program after the current scan. However, the PLC continues to scan the I/Os and processes host link commands sent to it and will report the current I/O data and internal variables to the host computer.

### 16.32 Resume PLC Operation

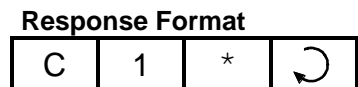
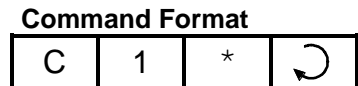

When the PLC receives this command, it will resume execution of the ladder program if it had been halted previously by the "C2" command. Otherwise, this command has no effect.

### 16.33 Read Analog Input

This command forces the PLC to refresh the value of its ADC data at the analog channel before returning its value in the response string (i.e. no need for the PLC to execute ADC(n) function to refresh the analog input)

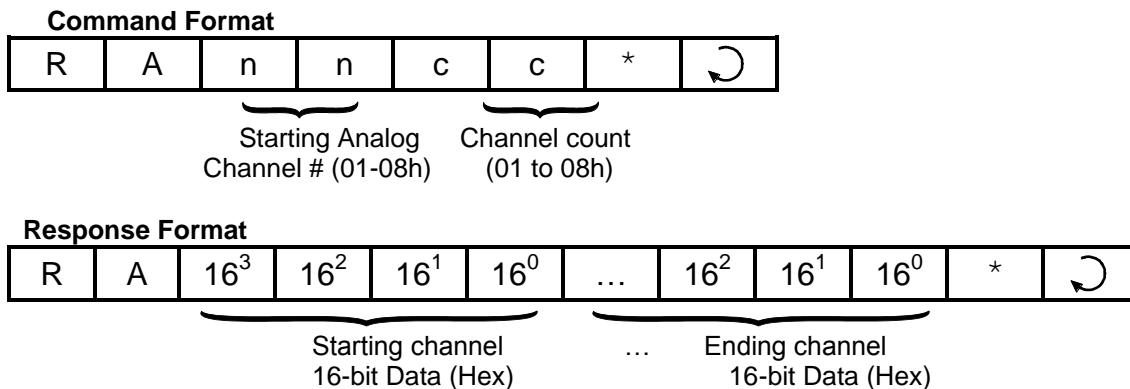

E.g. To read 4 channels of Analog inputs starting from Ch #2, Send "RA0204\*". The response string will contain 4 sets of data for channel 2, 3, 4 and 5.

### 16.34 Read EEPROM Integer Data

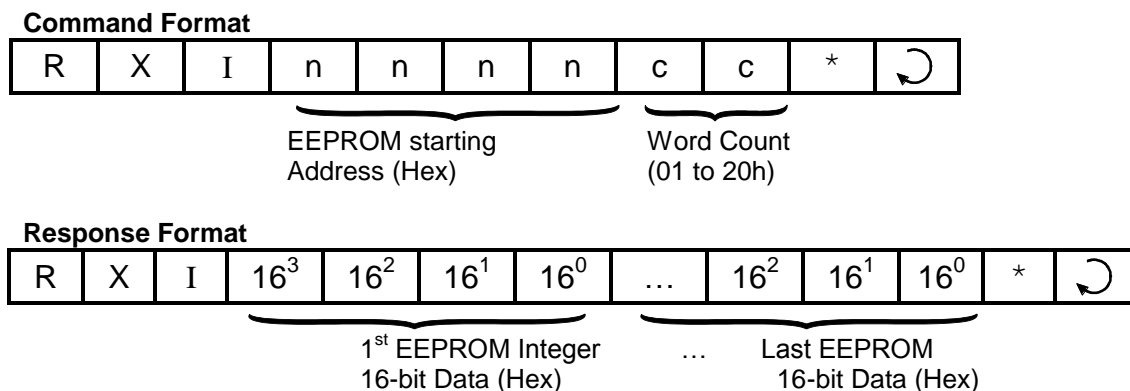

Maximum allowable word count per command is 32 (01 to 20 Hex). If "count" is > 32, only the first 32 words will be returned.

E.g. To read the 10 words of EEPROM data starting from address 100, send host-link command "RXI00640A\*". The response string will contain 10 sets of 16-bit data (4 ASCII hex digit per set).

### 16.35 Read EEPROM String Data (*r47 Firmware Only*)

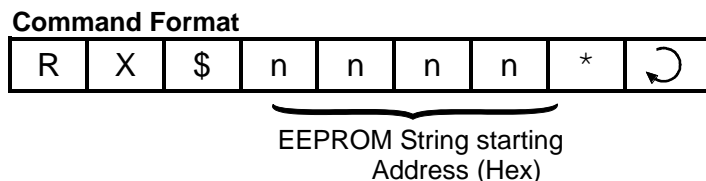

**Response Format**



E.g. To read the string data stored at EEPROM address 10, send host-link command “RX\$000A\*”. The response string will contain string data stored in the EEPROM (maximum 40 characters).

### 16.36 Write Analog Output

Upon receiving this command, the PLC updates the value of its DAC data at the analog output channel (i.e. no need for PLC to execute SETDAC to update the analog output).

**Command Format**

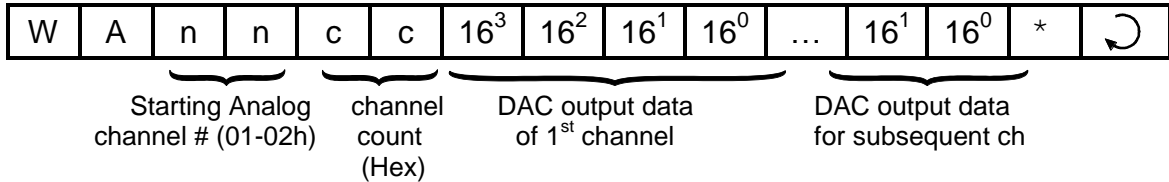

**Response Format**

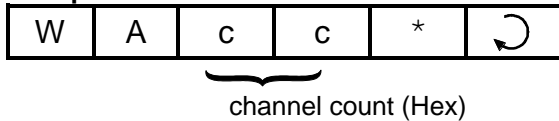

### 16.37 Write EEPROM Integer Data

**Command Format**

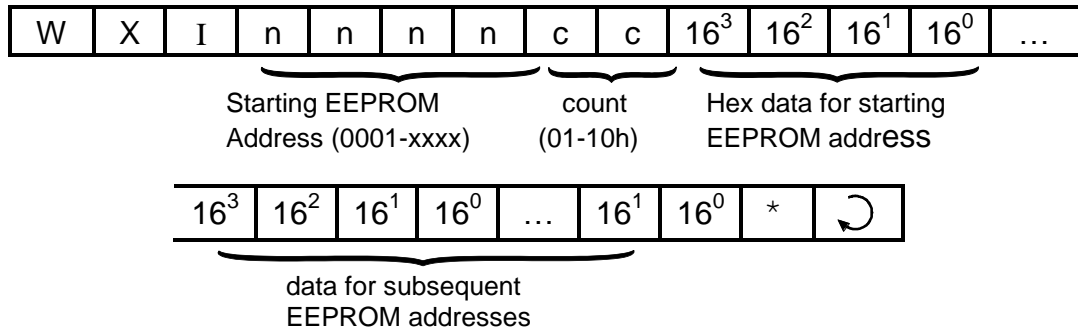

**Response Format**

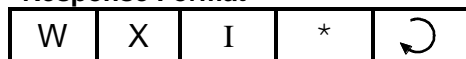

Maximum allowable word count per command is 16 (01 to 10 Hex).

### 16.38 WRITE EEPROM String Data

**Command Format**

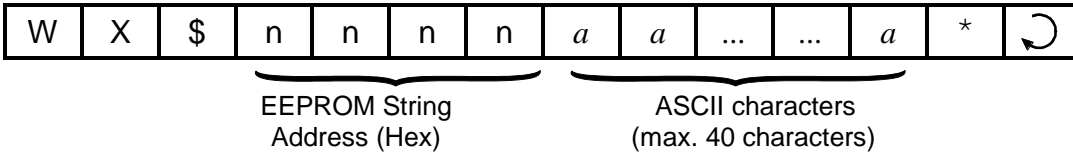

**Response Format**



E.g. To write the string data "Hello TRi" at EEPROM String address 12, send host-link command "RX\$000CHello TRi\*".

### 16.39 Force Set/Clear Single I/O Bit

This new "Wbnnnxx" command allows you to change a single I/O bit on the PLC. You can force set or clear any single input, output, relay, timer or counter bit. This has an advantage over other write commands such as WI, WO, etc that affects the entire group of 8 or 16-bits organized into "channels".

**Command Format**

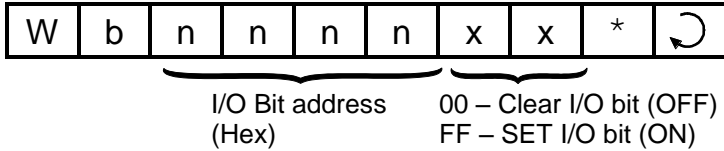

**Response Format**



I/O Type	Bit address nnnn (Hex)
Input #1 to #256	0000 to 00FF
Output #1 to #256	0100 to 01FF
Timer #1 to #256	0200 to 02FF
Counter #1 to #256	0300 to 03FF
Relay #1 to #256	0400 to 04FF
Relay #257 to #512	0500 to 05FF

E.g. To force output 1 to ON, send "wb0100FF\*". To turn it OFF, send "wb010000\*"



## 16.40 Using OMRON Host Link Commands

Since the PLCs also support OMRON C20H Host Link commands, which are very similar in construct to our multi-point command/response format, you can also make use of OMRON commands to supplement the native host link commands.

We will only discuss four of the OMRON host link commands “RR”, “WR”, “RD” and “WD” in this section because these commands can be used by users to read/write to **multiple** I/O registers and data memory in a single command (Note: maximum length of command string should be <=80 characters).

Note: Since the Nano-10 native protocol command set typically only supports read/write of single variables and data memory, if you want to read/write multiple memory locations in a single command, you can make use of these OMRON host link commands.

### 16.40.1 Read IR Registers

This command refers to Table 14.1 in Chapter 14 to map the PLC’s I/Os to OMRON IR register space from IR0 to IR519

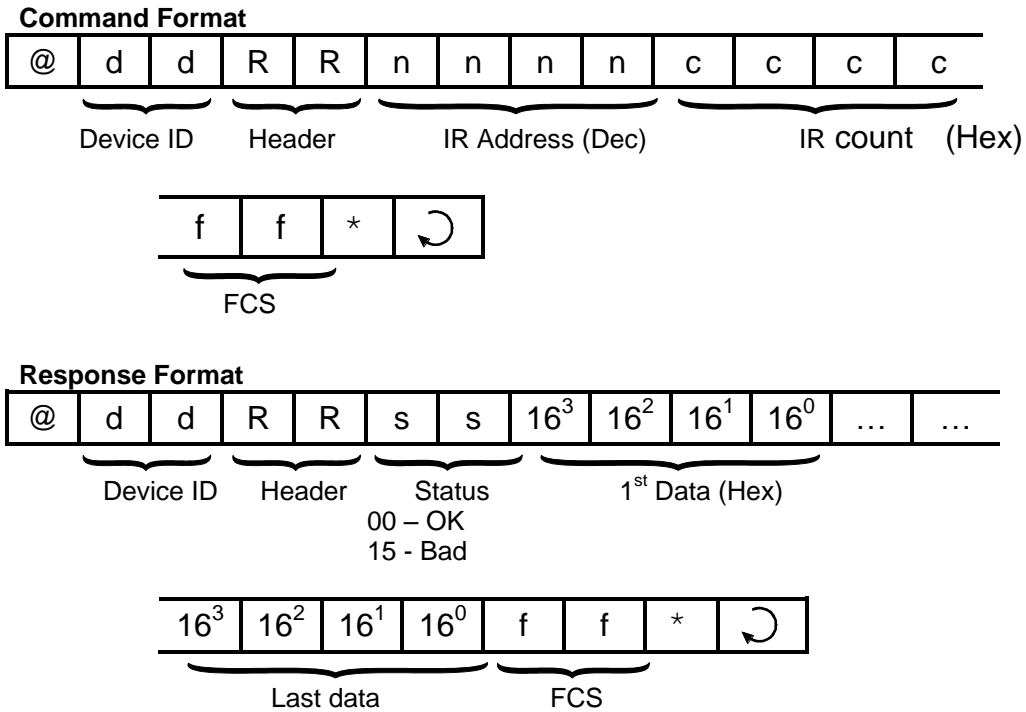

E.g. To read Timer PV #1 to #7 using this command, send:

“@01RR012800074D\*”

The PLC will send return a response “@01RR00xxxxxyyyzzzz...\*”

### 16.40.2 WRITE IR Registers

This command refers to Table 14.1 in Chapter 14 to map the PLC's I/Os to OMRON IR register space from IR000 to IR519

**Command Format**

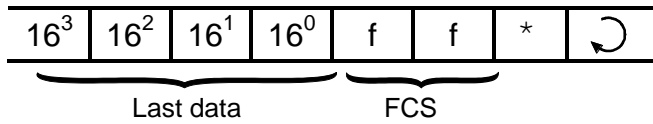
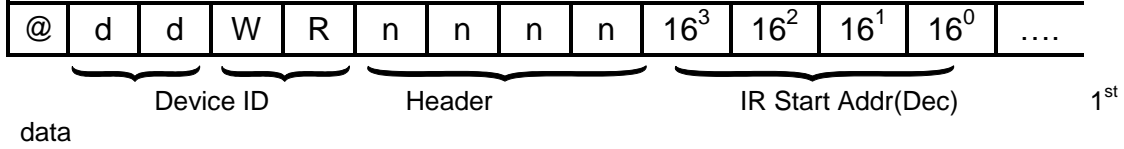

**Response Format**

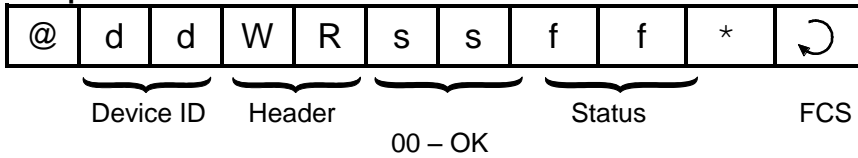

E.g. To Write to CtrPV #1 to #2 using this command, send:

`"@01WR0256xxxxxyyyff"`

where xxxx and yyyy are the hex values to be written to CtrPV 1 & 2.

### 16.40.3 Read Data Memory DM[1] to DM[4000]

**Command Format**

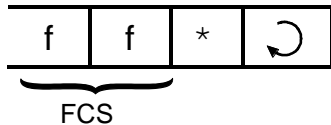
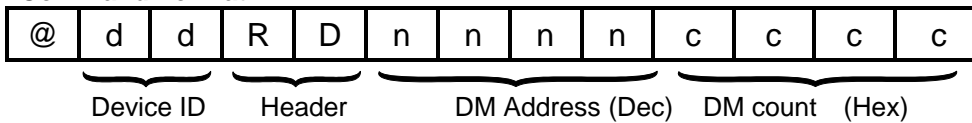

**Response Format**

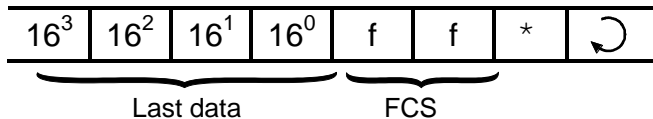
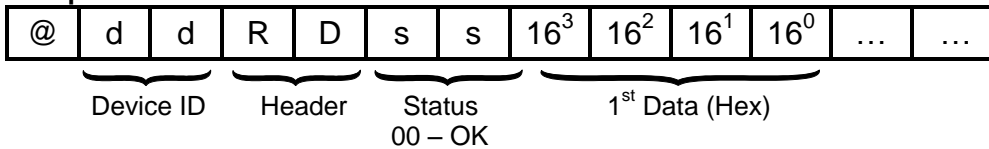

E.g. To read DM#112 to #130 (19 words), send:

```
"@01RD0112001357*"
```

The PLC will send return a response "@01RD00xxxxxyyyzzzz...\*"

#### 16.40.4 WRITE Data Memory DM[1] to DM[4000]

##### Command Format

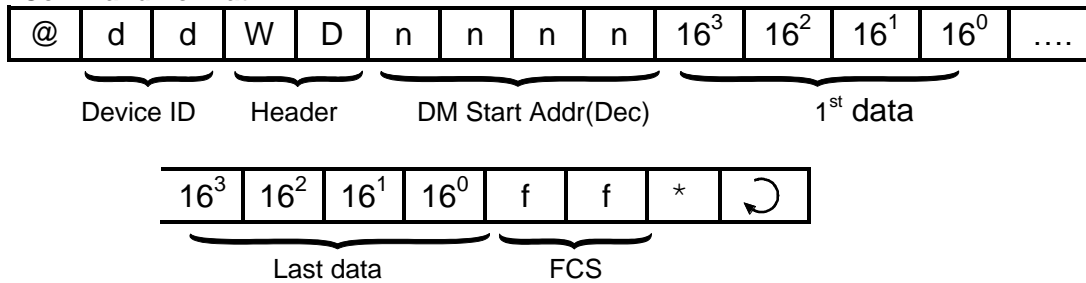

##### Response Format

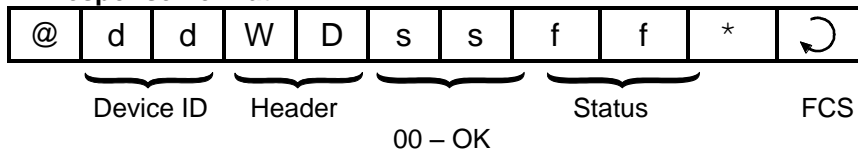

E.g. To Write to DM#1200 to #1201 using this command, send:

```
"@01WD1200xxxxxyyyff*"
```

where xxxx and yyyy are the values to be written to DM[1200] & DM[1201].

## 16.41 Testing of Host Link Commands

You can try out all the Host-Link commands using TLServer's "Serial Communication Setup". However, TLServer is designed to accept only multi-point protocol commands except the "IR\*" command (which is necessary to obtain the device ID from the PLC). You, therefore, have to enter all your host link commands in multi-point format.

Since the multi-point protocol requires an FCS (frame check sequence) character to be appended to the end of the command string, you may be able to get around it by using the "wildcard" FCS "00" in place of the actual FCS. E.g. To read input channel 02 from a PLC with ID = 01, you can enter the command string as "@01RI0200\*".

For TLServer version 2.1 and above, there is an "FCS" button that lets you compute the actual FCS for the string in the command string text field. You can then use the actual FCS with the command string to completely test your command. E.g. If you type in the string "@01RI02" in the command string (but do not press Enter) and then click on the "FCS" button, the FCS for this string will be computed and shown as "FCS = 58", as shown in the following figure:

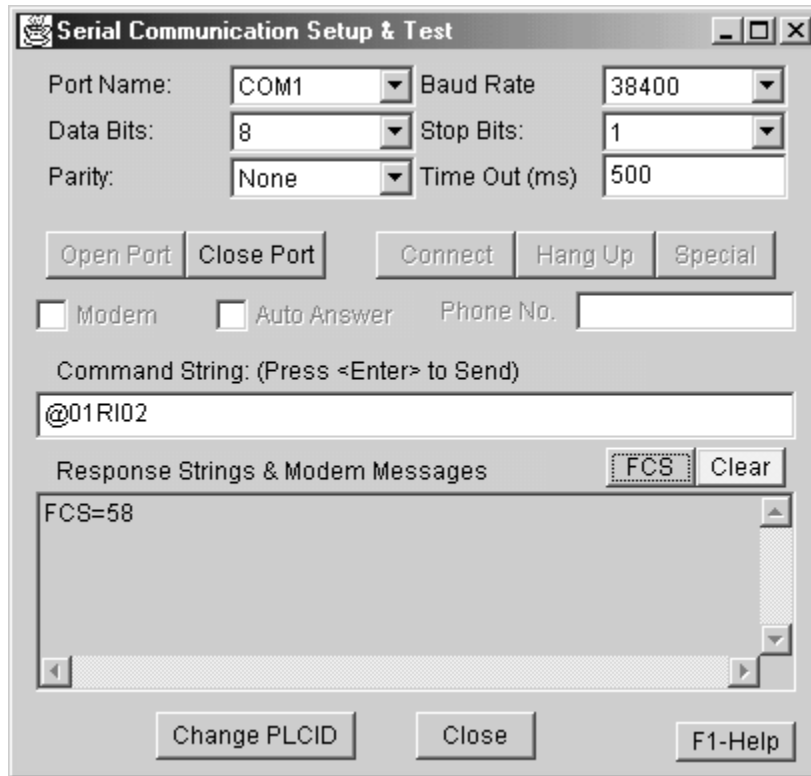

You now can enter the complete command string as "@01RI0258\*" and it will be accepted by TLServer. (Note: If the PLC has executed a SETPROTOCOL *n*, 5 to configure its serial port into pure native mode, then wildcard FCS will not be accepted and you must use the actual FCS with your command. The FCS button makes it much easier than computation by hand).

If you have changed some data using the write command, then activate On-Line Monitoring and examine the changes made using the "View Variables" window.

## 16.42 Visual Basic Sample Program

To help users get started writing their own Visual Basic program to communicate with the PLC, we have created a sample Visual Basic program with full source code listing. Please visit the following web page to download the visual basic sample program.

<http://www.tri-plc.com/applications/VBsample.htm>

---

## 16.43 Inter-PLC Networking Using NETCMD\$ Command

Nano-10 is able to send out host link commands to another Nano-10, FMD, F-series, M-series or even the E10 PLCs using the built-in TBASIC function `NETCMD$()`. This function accepts host link commands in multi-point format and automatically computes the Frame Check Sequence (FCS) characters, appends them to the command string and sends out the whole command string together with the terminators. The function then waits for a response string and checks the integrity of the received response string for errors. This function returns a string only if a proper response string has been received. Please refer to the TBASIC Reference for a detailed explanation of this command.

The `NETCMD$()` function therefore greatly simplifies the programming tasks for handling networking between PLCs. The programmer only needs to construct the correct command string according to the formats described in this chapter, pass the formatted string to the `NETCMD$()` function, and then check for the response string. The Nano-10 PLC may use the `NETCMD$` to map the I/O of another PLC into its internal relays and use the other PLC as its remote I/O.

There are some programming examples in your “`TRILOGI\TL6\usr\samples`” folder that illustrate the use of `NETCMD$()` to map I/Os of a slave PLC to the master. Please study the two examples: “`RemoteIO-Hseries.PC6`” and “`RemoteIO-Mseries.PC6`” carefully to understand the mechanism of mapping I/Os between the PLCs. The TRILOGI program “`REMOTE-Hseries.PC6`” will work on the H-series, M-series or F-series PLCs as slaves, whereas the program “`REMOTE-Mseries.PC6`” will only work with another FMD, F-series, Nano-10 or M-series slaves. This is because the F-series and M-series host link command set is a superset of the H-series host link command set, and this example uses the more efficient M-series host link commands to read/write 16-bit data for networking between M-series PLCs.

An application note and example programs demonstrating how to use our other PLC models as slave remote I/O for the F- or M-series PLC can be found at the following web page:

<http://www.tri-plc.com/appnotes/AppnoteMain.htm>

---

## 16.44 Inter PLC Networking Using MODBUS Protocols

The PLCs may also pass data to each other using special MODBUS commands, which are even simpler to use than `NETCMD$` but are restricted to accessing variables that are mapped into MODBUS address structure. Please refer to the Section 14.7 and 14.8 as well as the TBASIC Reference manual for details on using the `READMODUS`, `WRITEMODBUS`, `READMB2` and `WRITEMB2` commands.

## Chapter 17 I<sup>2</sup>C Communication

## 17 I<sup>2</sup>C COMMUNICATION

The Nano-10 PLC (with firmware r76 or later) supports the Inter-Integrated Circuit – IIC, also commonly known by the acronym I<sup>2</sup>C or I2C bus. Please refer to the I2C specifications of your device for detailed explanation of the I2C protocol.

Nano-10 only supports the I2C as a master and operates at 100KHz, which allows it to connect to many off-the-shelf components such as GPS, accelerometers, thermometer, analog I/O chips, etc. The PLC can connect to multiple I2C slaves in a multi-drop I2C bus, which greatly expands its capability. The built-in TBASIC commands also greatly simplify the I2C communication with the slave devices.

However, you can only use the I2C communication capability provided your Nano-10 meets **all** the following conditions:

- 1) You have installed the I2C interface module (such as the I2C-FRTC supplied by TRi) on the Nano-10.
- 2) You have upgraded your I-TRiLOGI software to version 6.40 or later.
- 3) The PLC firmware is  $\geq$  r76,

**Note:** The I2C-FRTC is intended for advanced users only, so it may not be available for general online sales in the shopping cart system. If you wish to obtain pricing or would like to place an order, please contact sales directly via email ([sales@tri-plc.com](mailto:sales@tri-plc.com)) or phone (877 874 7527) to inquire.

### 17.1 The I2C-FRTC Module

#### 17.1.1 Installing the I2C-FRTC Module

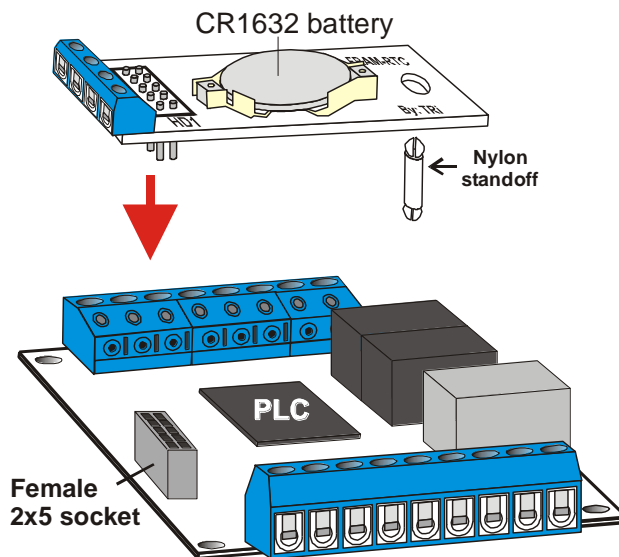

To install the I2C-FRTC module, first **ensure that you have turned OFF** power to the PLC.

The I2C-FRTC module has a row of 2x5 male header pins that is to be inserted into the single mating 2x5 female socket on the PLC. Please ensure that the pins are aligned correctly with the socket. There is a single mounting hole on other end of the I2C-FRTC module, which provides support to the module via a

nylon standoff included in the I2C-FRTC package. You should also find a matching hole on the Nano-10 PLC which is aligned with the mounting hole on the I2C-FRTC module. The nylon standoff has two supporting catches that will mate to the mounting holes on both the I2C-FRTC and the PLC and it provides a fairly strong support to the I2C-FRTC module.

### 17.1.2 I2C-FRTC Hardware Overview

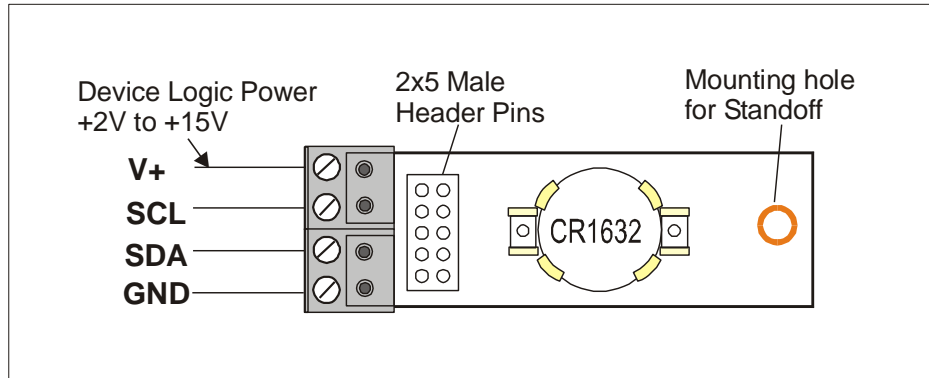

The I2C-FRTC modules adds the following hardware to the Nano-10:

- I<sup>2</sup>C communication interface chip
- 11K words of FRAM memory, Expand program memory to 16K words, DM[1001] to DM[4000] and a Battery-backed Real Time Clock (RTC) \*
- 128K** bytes of I2C EEPROM memory (M24M01) – Expandable to 256K bytes by soldering an additional M24M01 chip next to it on the blank solder pad.
- Additional Analog output channel #3 and #4 (0-5V only)

\* The FRAM memory and battery-backed RTC on the I2C-FRTC is identical to that found on the [FRAM-RTC](#) module. I2C-FRTC = FRAM-RTC + additional I2C hardware.

The I2C interface chip allows the Nano-10 PLC to interface to external I2C devices that are of different logic voltage level from the PLC. You must connect the positive logic voltage of the target device to the “V+” terminal shown in the above diagram and 0V of the target device to the “GND” terminal. Then connect the SCL and SDA signal between the I2C-FRTC module and target device and you are good to go.

A 1 M bits I2C EEPROM chip (M24M01) is also included in the I2C-FRTC module. This allows you to use the new I2C\_READ and I2C\_WRITE command (available only in I-TRiLOGI version 6.40 or later) to store and retrieve up to **128K bytes** of non-volatile EEPROM memory to store additional data. This will be described in the next section.

### 17.1.3 I2C-FRTC Availability

The I2C-FRTC is intended for advanced users only, so it may not be available for general online sales in the shopping cart system. If you wish to obtain pricing or would like to place an order, please contact sales directly via email ([sales@tri-plc.com](mailto:sales@tri-plc.com)) or phone (877 874 7527) to inquire.

## 17.2 New TBASIC Commands: I2C\_READ, I2C\_WRITE and I2C\_STOP

These 3 new TBASIC commands are only available on i-TRiLOGI version **6.40** and above, and they are only enabled on Nano-10 or FMD PLCs that are installed with I2C-FRTC. If you are still running the older version of I-TRiLOGI, you can get a free update by clicking on the “Help” menu on your production version



of I-TRiLOGI software and follow the “Upgrade TRiLOGI” link to download the latest I-TRiLOGI software in order to use these 3 newly added commands.

Both I2C\_WRITE and I2C\_READ commands use a range of data memory DM[ ] to transmit the data to be written into the device or to be read from the device. The parameters comprise the I2C slave address, the starting index of the DM[] memory location to use and the number of bytes to be sent/received from the slave.

### 17.2.1 I2C\_WRITE

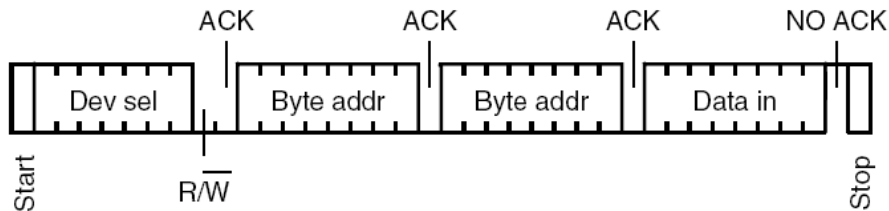

An **I2C\_WRITE** command begins with the master (PLC) sending the START bit, followed by a 7-bit slave address, and then a “R/W” bit set to low, which indicates that it is a WRITE command. If the slave device with the targeted slave address is present, it will send the ACK response to the master on the 9<sup>th</sup> clock cycle. Otherwise the master sends a STOP bit and quits the I2C\_WRITE function.

If the slave does send the ACK bit, the master will then send out a number of data bytes to be written to the slave and the slave will respond with the ACK bit with the completion of each byte it received. After the last data byte has been written to the slave, and if the master is not expecting to read any data from the slave, the master **must** then immediately send the **STOP** bit by executing the **I2C\_STOP** command (to be described later) to indicate the End-of-Write to the slave.

The PLC program can determine if the I2C\_WRITE is successful by checking with the STATUS(2) command. The syntax of the I2C\_WRITE command is as follow:

#### I2C\_WRITE *i2cslave, dmstart, count*

<b>Purpose</b>	Special command to execute a I2C WRITE out of the PLC's I2C port (if so equipped). The CPU will send a I2C START, followed by the slave address byte ( <i>i2cslave</i> ) and <i>count</i> number of data bytes from the DM[ <i>dmstart</i> ] up to DM[ <i>dmstart+count-1</i> ] <i>i2cslave</i> - The 7-bit slave address that the CPU is writing to. <i>dmstart</i> - The starting index of the DM[ ] that contains the first data byte <i>count</i> - number of byte data to send (maximum is dependent on the slave).
<b>Examples</b>	DM[5] = 12 : DM[6] = 34 : DM[7] = 56 <b>I2C_WRITE &amp;H60,5,3</b> I2C_STOP
<b>Comments</b>	<i>Following the START bit, the CPU will write the 7-bit slave address &amp;H60 (=110 0000 binary) and a R/W bit set to 0, followed by the byte data stored in DM[5], DM[6] and DM[7].</i>  <i>The command automatically checks for ACK received from the slave device , and the user program can check the status of this operation by testing the STATUS(2) function. STATUS(2) returns a 1 if ACK is received , and 0 if no ACK is received after time out.</i>  <i>Note: This command <b>does not</b> automatically generate the I2C STOP bit, this is to allow the</i>

*CPU to perform a I2C\_READ following a I2C\_WRITE. I2C READ after WRITE is commonly encountered in I2C protocol which requires using the I2C\_WRITE to set the internal pointer address in the slave device and then followed by the I2C\_READ command.*

*Therefore, if your command involves only I2C\_WRITE, you must end the WRITE command by executing a I2C\_STOP statement.*

### 17.2.2 I2C\_READ

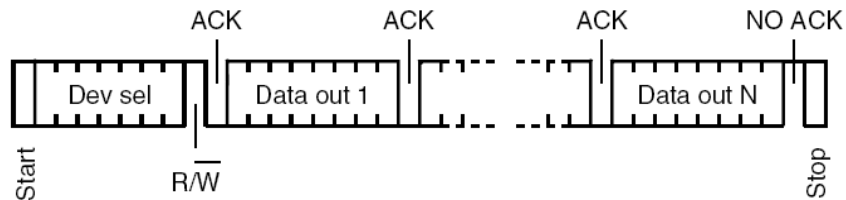

An **I2C\_READ** command begins with the master (PLC) sending the START bit, followed by a 7-bit slave address, and then a "R/W" bit set to high, which indicates that it is a READ command. If the slave device with the targeted slave address is present, it will send the ACK response to the master. Otherwise the master sends a STOP bit and quit the I2C\_WRITE function.

If the slave does send the ACK bit, the master will then toggle the SCL (clock) signal and the slave will send the data byte one bit at a time in response to the SCL pulses. After an 8-bit byte has been received, the master will automatically send the ACK bit to the slave and the slave will continue to send the next byte sequentially out to the master.

After the last data byte has been read from the slave, the master will not send the ACK bit but will automatically send the **STOP** bit to the slave. This indicates the End-of-Read to the slave and the communication is complete.

#### I2C\_READ *i2cslave, dmstart, count*

Purpose	<p>Special command to execute a I2C_READ out of the PLC's I2C port (if so equipped). The CPU will send a I2C START bit, followed by the slave address byte (<i>i2cslave</i>) with "R/W" bit set to high, and then send out the number of clock pulses required to read <i>count</i> number of data bytes from the the slave. The data bytes received from the slave will be stored in the memory location DM[<i>dmstart</i>] to DM[<i>dmstart+count-1</i>]. After receiving all the required data bytes the CPU automatically send the I2C <b>STOP</b> bit to the slave to end the communication.</p> <p><b><i>i2cslave</i></b> - The 7-bit slave address that the CPU is reading from.  <b><i>dmstart</i></b> - The starting index of the DM[ ] that is to receive the first data  <b><i>count</i></b> - number of byte data bytes to read from the slave.</p>
Examples	<pre>I2C_READ &amp;H0C,21,2 ' read 2 bytes into DM[21] and DM[22]</pre>
Comments	<p>After sending the START bit, the CPU will write the 7-bit slave address &amp;H60 (=110 0000 binary) and a R/W bit set to 1, followed by 16 clock pulses to read 2 bytes of data and store into DM[21] and DM[22], and then the CPU will generate the STOP bit.</p>

	<p><i>i.e. there is no need execute the I2C_STOP command after an I2C_READ command.</i></p>
--	---

### 17.2.3 I2C\_STOP

This command has no parameter. It sends a STOP bit to the slave and complete the I2C\_WRITE command.

### 17.2.4 Random Write To M24M01 EEPROM

The first M24M01 EEPROM on the I2C-FRTC (U2) has two binary slave device addresses: 101 0000 b (&H50) and 101 0001b (&H51). Device address &H50 is for accessing the first bank of 64K bytes of EEPROM, and address &H51 is for accessing the second bank of 64K bytes of EEPROM.

There is also a blank solder pad on the bottom layer of the I2C-FRTC module, which allows you to solder an additional M24M01 (U3) to the I2C-FRTC PCB. When assembled this second M24M01 chip will assume the binary address of 101 0010b (&H52) and 101 0011b (&H53). Device address &H52 on U3 is for accessing the first bank of 64K bytes while device address &H53 is for accessing the second bank.

Please refer to the M24M01 EEPROM data sheet for the detailed description of the addressing scheme for writing a byte of data to a random EEPROM address. The following picture depict the necessary command:

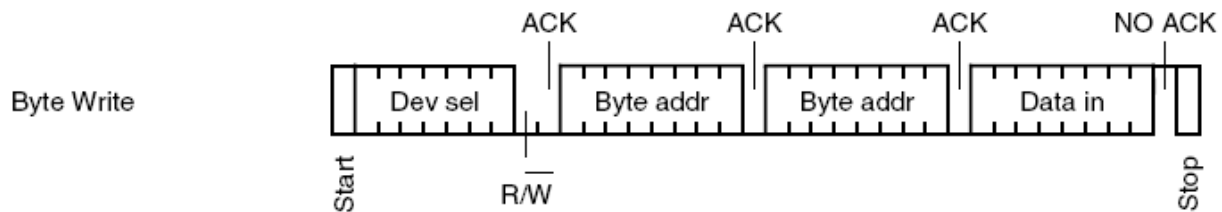

Example. To write a byte of data XX to the EEPROM address 54321 (&HD431) in first 64K bank, you need to do the following:

```
DM[11] = &HD4
DM[12] = &H31
DM[13] = xx    ` your data byte

I2C_WRITE &H50, 11, 3    ` write 3 bytes of data from DM[11] to DM[13]
I2C_STOP           ` necessary to end the byte write.
```

The data XX will be written to the EEPROM address 54321

If you want to store the data to second bank of EEPROM address, then replace the I2C\_WRITE line with:

```
I2C_WRITE &H51, 11, 3
```

### 17.2.5 Page Write To M24M01 EEPROM

As you can see, writing a single byte of data to a random location involves 4 bytes of data transfer, which is not very efficient. Fortunately, the EEPROM allows you to write more than one byte to the EEPROM and the EEPROM will write to the subsequent location sequentially. This is known as “Page Write” and you can write up to 256 bytes in the same page. A page is defined as the memory location having the same upper address byte (bit 8 to bit 15). E.g. Address &HA011 and &HA0FF are in the same page. But

address &HA0FF and &HA100 are **NOT** in the same page even though they are adjacent memory location. So you have to keep the page boundary in mind when performing a page write.

The following picture depict the page write command:

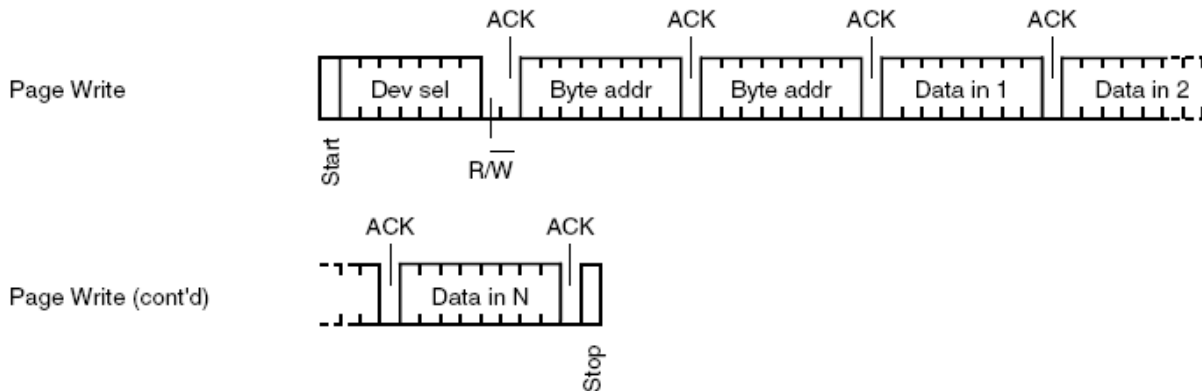

Example. To write 4 byte of data XX to the EEPROM address 19876 to 19879 (&H4DA4) in first 64K bank, you need to do the following:

```
DM[11] = &H4D
DM[12] = &HA4
DM[13] = xx    ` your data byte 1
DM[14] = yy    ` your data byte 2
DM[15] = zz    ` your data byte 3
DM[16] = ww    ` your data byte 4
```

```
I2C_WRITE &H50, 11, 6    ` write 6 bytes of data from DM[11] to DM[16]
I2C_STOP          ` necessary to end the write cycles.
```

The data contained in DM[13] to DM[16] will be written to the EEPROM address &H4DA4 to &H4DA7.

### 17.2.6 Random Read From M24M01 EEPROM

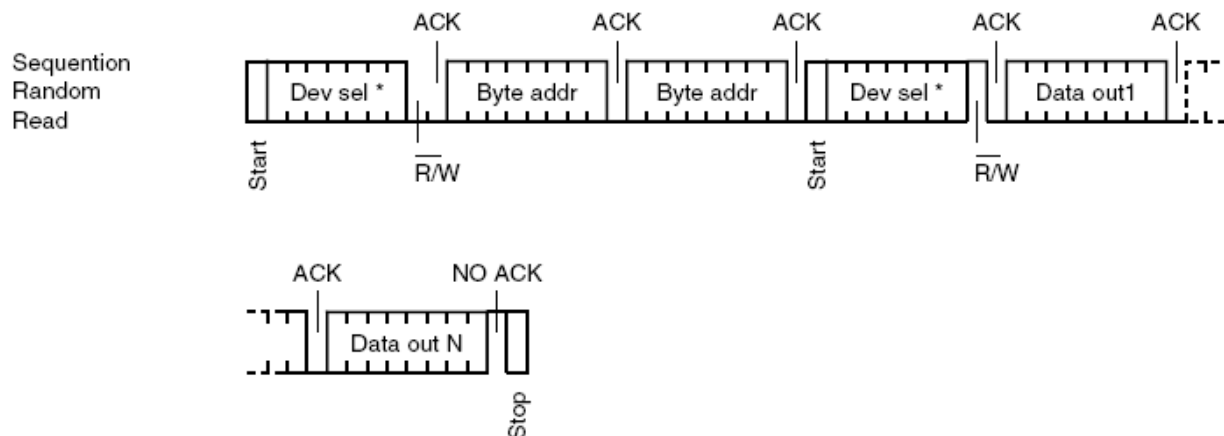

Reading data from a random EEPROM location is slightly more involved than writing. You need to first use the I2C\_WRITE command to set the memory pointer inside the M24M01 to point to the memory address location, then immediately followed by I2C\_READ command to read one or more data bytes starting from

the pointer address. After every byte is read the internal pointer will be incremented automatically and point to the next address byte, this allows you to read a large number of data sequentially from the EEPROM with minimum overhead. This can be very useful for “data dump” to the TLServer to rapidly upload the collected data

Example. To Read 100 bytes from EEPROM address 12345 (&H3039) to 12444 in first 64K bank, you need to do the following:

```
DM[11] = &H30
DM[12] = &H39
I2C_WRITE &H50, 11, 2  \ write 2 bytes of address in DM[11] to DM[12]
I2C_READ &H50,21,100  \ read 100 bytes data into DM[21] to DM[120]
```

The returned data will be stored in the DM[21] to DM[120].

Note: There is no need to execute the I2C\_STOP command after the I2C\_READ since the I2C\_READ command automatically sends a STOP bit after the last byte is read.

### 17.2.7 Sequential Read From M24M01 EEPROM

Note that after a random read, the memory pointer inside the M24M01 will be pointed to the next address following the very last read memory address. This means that you could repeatedly execute only the I2C\_READ command to read more data sequentially from the EEPROM memory.

Example:

```
DM[11] = &H30
DM[12] = &H39
I2C_WRITE &H50, 11, 2  \ write 2 bytes of address in DM[11] to DM[12]
FOR I = 1 to 10
  I2C_READ &H50,21,100  \ read 100 bytes data into DM[21] to DM[120]
  CALL Datadump  \ call some subroutine to upload data to server.
NEXT
```

In the above example, the I2C\_READ command was executed 10 times, each time 100 data point is read into DM[21] to DM[120] and the program then calls another custom function to dump these data points to the server. The loop then continue for another 9 times, and hence altogether 1000 data points from address 12345 to 13344 can be uploaded to the server in a simple FOR..NEXT loop.

## Chapter 18 Extended File System

## 18 EXTENDED FILE SYSTEM

Before you begin, please download a sample I-TRiLOGI program that will be referred to throughout this section from our website:

<http://www.tri-plc.com/trilogi/ExtendedFileSystem.zip>

### 18.1 Introduction

A Nano-10 or FMD PLC with r77 or later firmware may be used with a new module - FRAM-RTC-256, which, besides adding 11K words of FRAM (see Section 1.7.2) and a battery-backed RTC module, also adds 256K bytes of extended data file space to the PLC.

**Note:** The I2C EEPROM memory on the I2C-FRTC module (default =128K bytes, user-expandable to 256K) described in Chapter 17 can also be used as extended data file in exactly the same way as the FRAM-RTC-256. However, in the rest of this chapter we will only refer to the FRAM-RTC-256.

Without the FRAM-RTC-256, the Nano-10 PLC only has 60K bytes of file memory to be used for storing control web pages as described in [Chapter 2.9](#) (Note the default file space on the Nano-10 PLC before firmware r77 was 64K bytes, but it has been reduced to 60K to make space for the new r77 firmware).

FRAM-RTC-256 adds an additional 256K bytes of file space to the PLC. You can use the extended file space for storing additional web pages. But more importantly, a PLC with a new r77 or later firmware can open a local data file in this file space and write/append data to it. The PLC can therefore log a large amount of data into one or more data files, which can be retrieved for analysis.

There are two ways to retrieve the stored data files from the PLC:

1. Download the file from the PLC's built-in web server: The file created by the PLC can be downloaded from the PLC's built-in web server using any web browser. This allows the user to access the data file at any time of the day.
2. Automatic FTP upload from the PLC to an external web-server: You can program the PLC to make an FTP client connection to any web server on the local network or on the Internet/Cloud and upload the data file it has created to the web-server using any filename.

Imagine what the Nano-10 or FMD PLC can do with this new uploading capability! The ability to log data locally and automatically upload the data to a web server transforms the FMD PLC into a potent data-logger! The PLC can be programmed to capture daily, weekly or monthly data and then periodically upload the data file to an Internet web server with a unique, time-stamped filename (E.g. "temperaturelog2012-01-01.xls"). This allows the PLC to log data completely unattended.

The data uploaded by the PLC to the external web server can be viewed or downloaded into a PC using any web browser, anywhere in the world. This allows you to carry out analysis of past logged data file for performance or diagnostic analysis at any time without having to physically access the PLC to retrieve the logged data.



### Advantage of Data Uploading

1. Although it is possible to directly access the PLC's internal web server to download the data file it has created, this requires active action by the user and to ensure that the data are retrieved before the file is full and has to be deleted by the PLC to create space to log new data.
2. By programming the PLC to upload the data periodically the PLC can delete the file after it has successfully uploaded the data file to free up space to accept new data. In other words the PLC will never run out of data space to log data since it can store the logged files on any server including the Cloud!
3. To directly access the file stored on the PLC from outside of the LAN, you will need to setup the router or firewall to "forward" the PLC's server port (e.g. 9080) to the PLC. If you have multiple PLCs logging data, then each PLC will need to have a different port number in order to properly forward the port. This not only complicates the setup, but also is often frowned upon by System Administrator and may not even be permitted by the corporate network security policy.
4. The PLC is designed to upload data to any web server via FTP passive mode by providing the login username and password. Using FTP passive mode allows the PLC to open a network connection to an external web-server to upload a file and then close the connection immediately. It does not require opening a port on your router firewall to permit external access to the PLC from the Internet. Hence there is no complicated router setup involved as there is no port forwarding required. It also eliminates the security risk from someone trying to take control of the PLC from outside of your LAN and is generally much more acceptable to the System Administrator.
5. If you have multiple PLCs in use, you can program each PLC to upload data to a different directory or append a different file name prefix, or to different servers, and once programmed all PLCs will happily log data unattended indefinitely!

## 18.2 File Structure and File Naming of The Extended File System

All of the information in chapters 2.9 and 2.10 of this manual regarding the built-in 60K bytes of web server space will apply to the extended 256K bytes of data file storage on the FRAM-RTC-256, with exception on the naming scheme which will be explained below:

1. All files in the Extended File space can only use the file name "Zxxx.yyy".
2. The xxx part of the beginning of the filename is a 3 digit decimal number which can be any number from 000 to 127.
3. The 'yyy' part of the file name is the "extension", and only the following MIME extension are accepted by the PLC:

**HTM, JPG, GIF, CSS, JS, BIN, TXT, JAR, ZIP, XLS**

Any other extension names will be replaced with "???". The MIME extension are respected by the web browser when you download a file from the built-in web server so you should always only store files with one of the above extension.

4. The file space is divided into 128 "slots" with each "slot" occupying 2K bytes. The file "Z000.yyy" occupies the first slot, "Z001.yyy" occupies the 2<sup>nd</sup> slot .., and the file "Z127.yyy" the last 2K slot.
5. Any file may occupy more than 1 slot so you can specify "Z000.yyy" to occupy the entire 256K bytes of the file space. Or you can configure "Z000.yyy" to occupy the first 5 slots (10K total) and

the next valid file should start from Z005.yyy which can occupy the next 10 slots (20K bytes total). i.e. If you want to allocate 10K bytes of file space to file Z000.yyy you cannot not use name any file Z001, Z002, Z003 and Z004, otherwise these file will corrupt the file space of Z000.yyy

- This means that the programmer will have to design the file space carefully and determine how to best use the file structure to provide the right balance between the number of data files and the amount of data space allocated to each data file.

**Note:** The file name restriction only applies to files stored on the PLC's internal file space. When you use the FTP upload function described later, you can specify **any destination filename** as long as they are acceptable to the external FTP server.

## 18.3 Transferring Files To The PLC's Web Server

If you are only using the extended file space for the purpose of storing additional web pages on the built-in web server, then you can use the FTP client software such as FileZilla client to transfer the program to the PLC. Section 2.9 of this Manual describes in details how to configure the FileZilla client to communicate with the PLC.

Please take note that files that are name 0.yyy, 1.yyy.....to T.yyy are only stored on the PLC's on chip flash memory. Only files that are named Z000.yyy, Z001.yyy....Z127.yyy are stored on the FRAM-RTC-256 as explained in the last section.

## 18.4 Accessing The Extended Data Files Using TBASIC

A Nano-10 PLC with r77 firmware can access the extended data file space (i.e. only file names from Z000.yyy to Z128.yyy) from within TBASIC. The PLC can open a new file for writing new data (essentially deleting the old file content), or open an existing file and append data to the end of the file. It can also open a file and read data from the file as ASCII strings. It can achieve this by using the **PRINT #8** and **INPUT\$(8)** functions, which will be described in details in the following sections.

### 18.4.1 Open A File For Writing New Data

Syntax: **PRINT #8 "<WRITE Zxxx.yyy>"**

where "Zxxx.yyy" is the file name. If successfully executed, the "<WRITE>" command will open the file and set the file pointer to the beginning of the file. Thereafter the PLC can start writing ASCII data to the file using the **PRINT #8 <string data>** command. [Note: the **PRINT #8** command automatically appends a carriage return to the end of the string data unless the string data is terminated with a semi-colon (;)].

When the PLC has completed writing data, it must close the file by executing the command: **PRINT #8 "</>"**.

E.g. 

```
PRINT #8 "<WRITE Z005.TXT>"
PRINT #8 "The current Greenwich Mean Time is"
PRINT #8 STR$(TIME[1]) ; " : " ; STR$(TIME[2]) ; " : " ; "00"
PRINT #8 "</>"
```

The CPU should use the STATUS(2) command to check whether the <WRITE> has been successfully executed before begin writing data to it. STATUS(2) command returns a 1 if "<WRITE>" operation is successful and returns a '0' if the operation failed. The following are some possible reasons that could cause the "<WRITE>" command to fail:

1. A previously opened File was not closed. The CPU can only write to a single file at a time so any opened file must be closed by the PRINT #8 "</>" command before another file can be opened for writing.
2. The FRAM-RTC-256 is not installed. The PLC can only write data to the extended data file space (i.e. file name Zxxx.yyy) which are only available if an FRAM-RTC-256 is installed.

## 18.5 Open A File For Appending Data To The End Of The File

Syntax: `PRINT #8 "<APPEND Zxxx.yyy>"`

where "Zxxx.yyy" is the file name. If successfully executed, the "<APPEND>" command will open the file and set the file pointer to the end of the file. Thereafter any string data following a PRINT #8 command will be appended to the end of the file. When the PLC has completed appending data, it must close the file by executing the command: `PRINT #8 "</>"`.

As per the "<WRITE>" command, the CPU should also use the STATUS(2) command to check whether the <APPEND> command has been successfully executed before begin writing data to it. Since the same reasons that could cause a "<WRITE>" command to fail would also cause the "<APPEND>" command to fail, please refer to the last section on a list of possible causes of failure.

### Example

```
PRINT #8 "<APPEND Z"+STR$(F,3)+".txt>"
S = STATUS(2)      \ Status(2) returns 1 if successful.
IF S <> 1 RETURN: ENDIF

FOR I = 1 to 100
  PRINT #8 STR$(I,4)+":This is the Appended first line"
  PRINT #8 STR$(I,4)+":This is the Appended second line"
  SETLCD 1,1, "Append #"+STR$(I,4)
NEXT
PRINT #8 "</>"      \ close the file
```

### 18.5.1 Delete A File

Syntax: `PRINT #8 "<DELETE Zxxx.yyy>"`

where "Zxxx.yyy" is the file name of the file to be deleted. There is no need to close a deleted file.

### 18.5.2 Open A File For Reading

Syntax: `PRINT #8 "<READ Zxxx.yyy>"`

where "Zxxx.yyy" is the file name of the file to be opened for reading. If the file has been successfully opened for reading after execution of the PRINT #8 "<READ>" command, the PLC can start to retrieve ASCII data from the file line-by-line using the INPUT\$(8) command. A line is either a string that is terminated with a Carriage Return character (ASCII 13), or is a 70-character long string (which is the

maximum length of any string variables A\$ to Z\$) without carriage return. In either case the return string does not contain the CR character itself.

The PLC can check if a file has been successfully opened for reading using the STATUS(2) function AFTER executing the PRINT #8 "<READ>" command. STATUS(2) will only return a 1 if a file has been successfully opened.

The PLC can determine if the End-of-File (EOF) has been reached using the STATUS(2) function after every INPUT\$(8) command has been executed. STATUS(2) returns a 65535 (previously 255) if the EOF has been reached. The PLC should then close the file by executing the "PRINT #8 "</>" command.

```

A$ = "<READ Z"+STR$(F,3)+".txt>"
PRINT #8 A$
SETLCD 1,1, A$

S = STATUS(2)
IF S = 0
  SETLCD 2,1, "Failed to Open File"
  GOTO @100
ENDIF
C = 0
WHILE 1
  A$ = INPUT$(8)
  S = STATUS(2)
  IF S >= 255 EXIT: ENDIF ' S = 65535 means EOF
  SETLCD 2,1,A$
  DELAY 20 ' So that reader can read from the screen.
  C = C+1
ENDWHILE

SETLCD 1,1, "Read " +STR$(C) + " lines "
@100
PRINT #8 "</>" ' close the opened file

```

## 18.6 Setting Up The FileZilla FTP Server

One important capability of the Nano-10 PLC with r77 firmware is the ability to upload files created by the PLC to an external server on a local area network or on the Internet via the FTP protocol. If you have access to an FTP username and password on your company's server (or if the SysAdmin is authorized to set up an account for you) you can certainly use your own account for testing. If not, you can download the free Filezilla FTP Server and set it up for testing. The "ExtendedFileSystem.PC6" has an FTP upload demo and it was configured to work with a FileZilla FTP server.

Using Filezilla has the advantage that you can see the login sequence performed by the PLC when it attempts to connect to the FTP Server so that it is easier to troubleshoot connection problem. (For professional grade troubleshooting, one handy program to have is the "Wireshark" program which is a TCP/IP packet sniffer that allows you to look at the actual TCP/IP packets sent between your PC and the PLC). However, it is important to setup the Filezilla server program properly to minimize connection trouble.

### 18.6.1 Download and Setup FTP Server

1. First download the FileZilla server installer from the following website:

<http://filezilla-project.org/download.php?type=server>

2. Run the "FileZilla Server Interface" program, which is meant for managing the FTP Server settings.

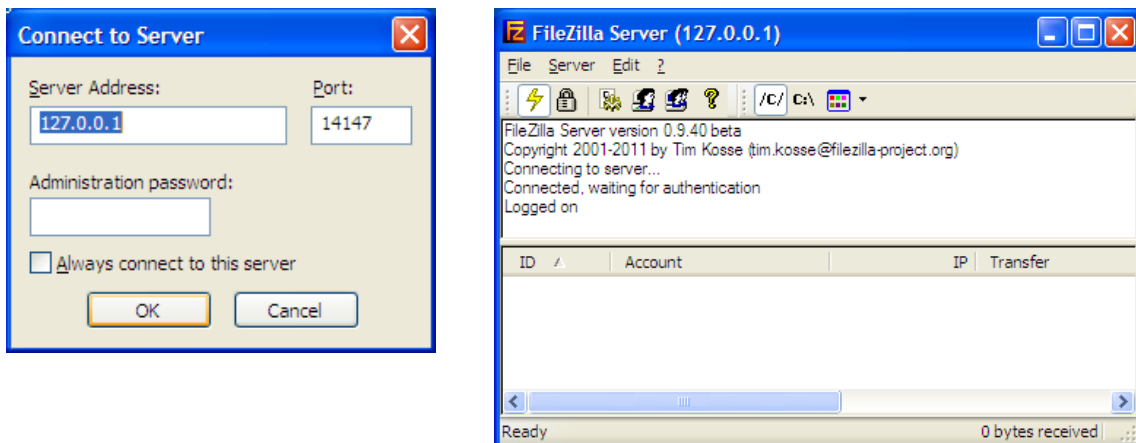

3. If the FileZilla Server is running on the same PC that you are running the FileZilla Server Interface program then you can use the localhost IP address which is 127.0.0.1 – the Port can be anything since this is a client port that the Interface program is using to interact with the FTP Server (don't be confused with the FTP **Server** listening port which is by default = 21).
4. If this is the first time you run the program after setting up Filezilla FTP Server there will be no Administration password so you can leave it blank. Click OK to connect.
5. Click "Edit->Settings" and then "General Settings -> Welcome message" – leave **only one line** of welcome message so that the PLC has less work to do. Then click OK to accept the change.

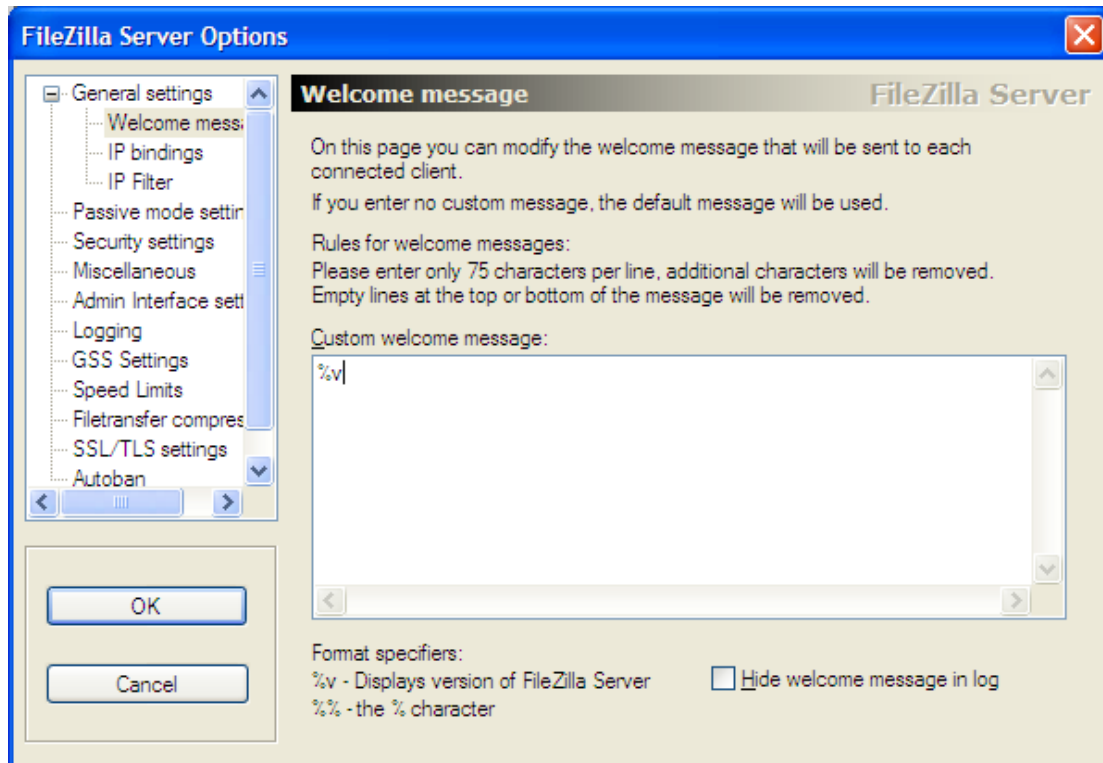

6. Click "Edit → Users" in order to setup a user name and password for your test. The "ExtendedFileSystem.PC6" program uses a username = "PLC" and password = "1234" so for a quick test you may like to setup the same username and password:
7. At the "General" page of the setup screen, click "Add" button at the "Users" pane to add a username "PLC". Since no group has been defined simply leave the default as "<none>" in the second text box as shown in the following diagram.

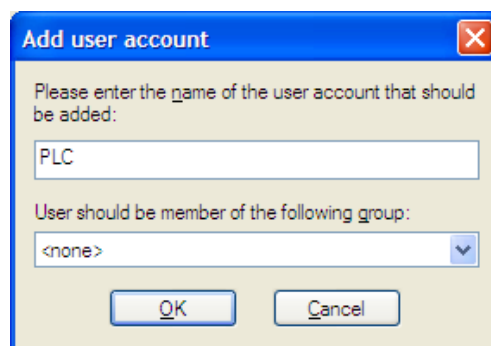

8. Next click "Shared folders" page and you must setup a folder that is to be used to receive uploaded file. Click "Add" at the "Directories" pane to add the folder. You can choose any folder on your PC to be used for the FTP upload and you just have to remember the location so that you can look for the uploaded file later in the test. However, **make sure that you check all the check boxes** for "Read", "Write", "Append" etc as shown in the diagram.

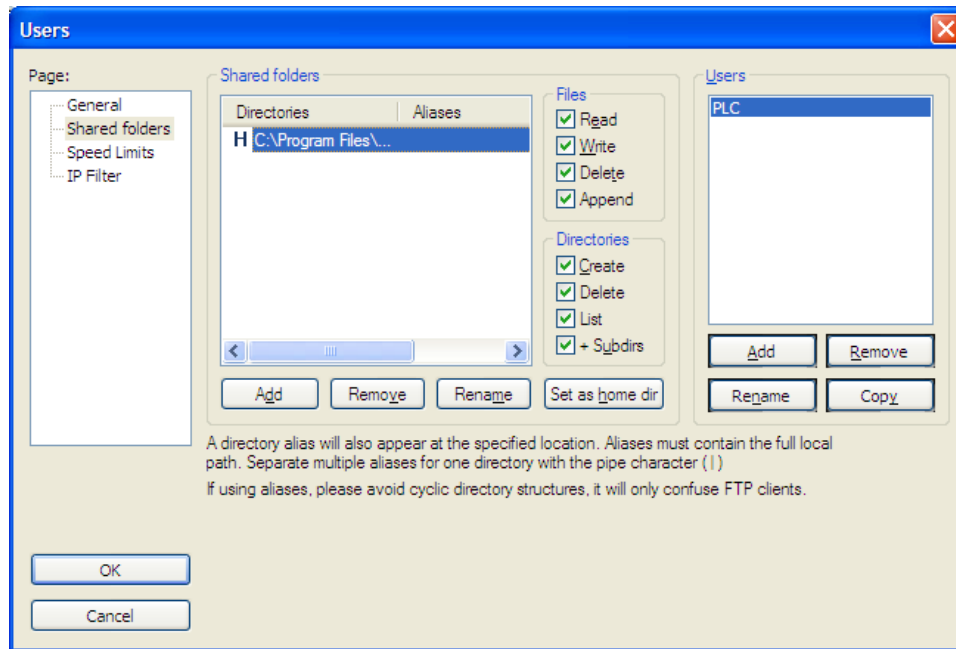

9. Click “OK” to complete the setup. The FTP server should now be waiting for connection.

### 18.6.2 Testing Connection To The FTP Server Using Telnet

You can now test the FTP Server using the FileZilla client as mentioned in Chapter 2.9 of the PLC User's Manual.

But a better way to test is to use the “Telnet” program on your PC (if you are running Windows Vista or Windows 7 you may need to enable the Telnet program since it is disabled by default – do a quick Google search on how to enable the Telnet client software on your PC).

Also you may want to find out the IP address of your PC that is running the FileZilla Server. If you have TLServer running on your PC your IP address is reported on the TLServer's front panel. You can also get the IP address from the Windows “Network Connection Status” as shown below. Our test PC has an IP address = 192.168.1.168 which will be used in the following tests as well as used in the PLC program to connect to the FTP Server.

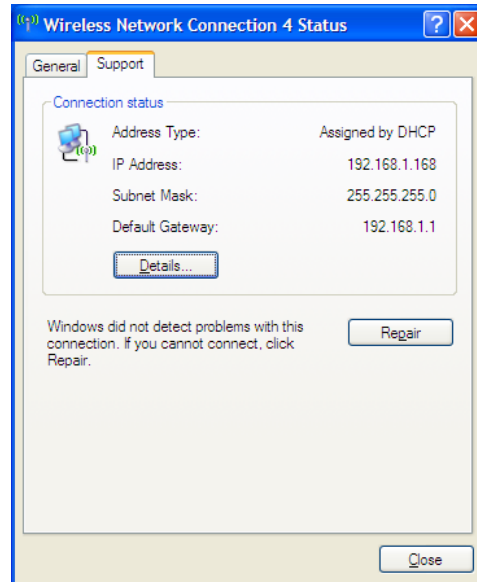
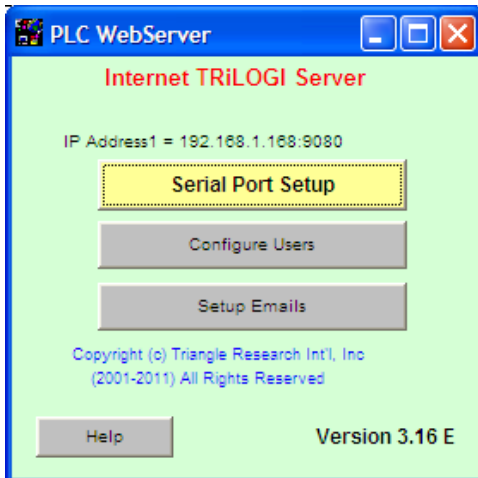

1. First open a command prompt window and then type “telnet 192.168.1.168 21” - this will open a telnet connection to the FTP server on our test PC with IP address 192.168.1.168 and listening at port 21. Please replace the IP address with the actual IP address of **your** PC. The following screen shot captures the test sequence. Note that the same command/response sequence with the server is also shown on the FileZilla Server Interface program front panel:

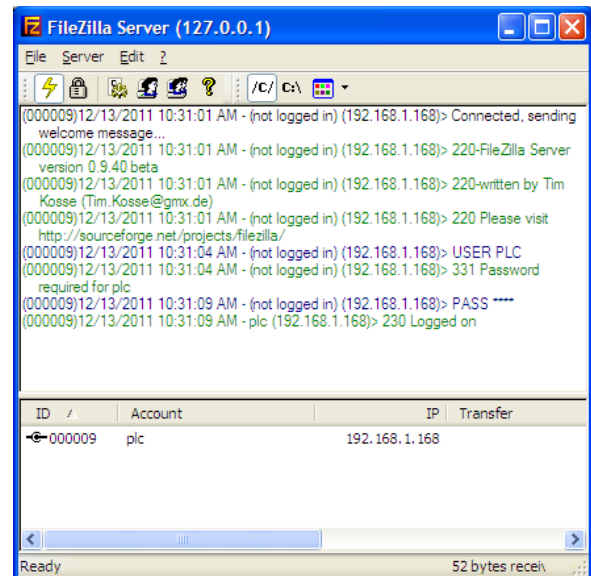
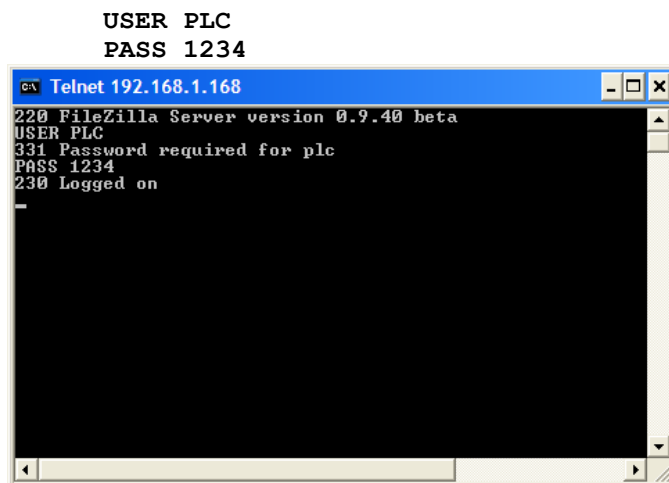

2. Once you get the “230 Logged On” message you know that the FTP setup is done correctly. Note that the welcome message from the FTP Server shows only one line “220 FileZilla Server Version x.xx” which is what we have set it up to be. You can now disconnect from the FTP server by typing “Quit” at the command prompt.
3. There is one more things you need to do before you proceed to test the FTP upload features of the PLC to avoid connection problem – that is to temporarily **TURN OFF the Windows Firewall and any software firewall setup by anti-virus software** during your test. You can always re-enable your software firewall(s) after the test if you wish. PC operating system are designed to run client program normally instead of acting as a server so Windows Firewall by default is to block all incoming



connections to the FTP Server. Thus it can give you a lot of headache when you are trying to connect to the FTP server operating behind the Windows Firewall.

**Notes:**

- a) The main purpose of Windows Firewall is to protect your PC when you are connected to say a public wi-fi network. But if your PC is connected to the Internet via a router at work or at home, the router hardware itself would act as a firewall to isolate your PCs and a software Firewall is actually redundant. (If a hacker tried to connect to a port using your public Internet IP address what he reached would be the port on the router and he would not be able to reach your PC unless you have specifically set up to forward all TCP/IP messages sent to that port to a specific PC).
- b) If you really want to use the Filezilla FTP Server as a permanent server on a PC to receive files, and still want to have the Windows Firewall enabled, you can refer to the last section in this chapter which describes how to do it.

## 18.7 Uploading File From PLC to FileZilla FTP Server Directory

### 18.7.1 Overview of The FTP Protocol

The FTP protocol requires **two** socket-connections between the devices performing the file transfer. One connection is the “command” channel where FTP commands such as STOR or DELE and the responses are sent as plain ASCII text strings between the FTP client and the FTP server. The second connection is the “data” channel where only the file content or the file directory data are being transferred.

There are two transfer modes: “Active” mode and “Passive” mode. Active mode requires that the **server** establish a data connection back to the **client**. Passive mode on the other hand, requires that the client also be the one to establish the data connection. i.e. For passive mode, both the command and the data connections are performed by the client (the PLC in this case).

The PLC has been designed to **use only passive mode** to transfer file to the FTP server. Passive mode is preferred because that is the only way to transfer file if the FTP Server is located on the Internet. The alternative active mode transfer requires the server to make a data connection back to the PLC that is sitting behind a router firewall, and that can be problematic unless the router is specifically configured to forward the data port to the PLC.

### 18.7.2 PLC FTP Upload Procedure

In order to upload file to the FTP Server, the PLC would use the PRINT #4 “<TCPConnect xxx.xxx.xxx.xxx:21>” command tag to connect to the FTP server port 21 to establish the “command” connection to the FTP Server. The PLC uses its PRINT #4 to send and INPUT\$(4) to receive ASCII text strings from the FTP server via the command channel. The PLC would then send the command “PASV” to inform the FTP server that it wants to transfer a file in passive mode.

At this point you can use the PRINT #4 command to send any valid FTP command to the server, including changing directory (CWD command – make sure the directory exist), deleting a file (DELE command – beware of what you are deleting!) etc.

When the PLC is ready to start a file transfer to the FTP server, the server will in turn provide the PLC with the port number that it has opened for the PLC to connect to establish a data connection. Upon receiving this port number the PLC will make a second TCP connection to the given port and then the actual file transfer will begin.

A new, network service command tag named “FTPUPLD” handles the negotiation between the FTP Server and the PLC as well as handling of the data transfer from the PLC to the FTP server. The following is the syntax:

```
PRINT #4 "<FTPUPLD Zxxx.yyy [destination file name]>"
```

Where: Zxxx.yyy is the file name of the extended file that the PLC has access to. The [destination file name] can be any legal name acceptable to the server so you can attach a date or time stamp to the file name for easy identifications.

When the above <FTPUPLD> command is run, the PLC will send the actual “STOR” command in the background to the FTP server and then obtain the port number from the server and it will then make a data connection to it, and file transfer can then begin.

### 18.7.3 Monitoring The FTP Upload Progress

Once the file transfer begins the PLC firmware will handle the rest of the file transfer until either the file has been completely transferred or the transfer is aborted due to a network or server trouble. You can monitor the progress of the file transfer using either the **STATUS (4)** or **STATUS (20)** functions.

**STATUS (4) =**

- 0 : FTP client was idle or last FTP failed
- 1 : FTP data transfer just started
- 2 : 1st FTP segment transferred, now transferring the rest
- 3 : FTP data transfer completed.

**STATUS (20) > 0:** Number of bytes uploaded to FTP Server. Transfer is in progress.  
**< 0:** Total number of bytes uploaded. Transfer completed.

For example, If 2,345 bytes has been uploaded to the server and the transfer has ended, **STATUS (20)** will return the number = -2345.

Since file transfer can take substantial amount of time to complete, it is not wise to run a loop to wait for the file transfer to complete since this will block the PLC from processing any other part of the program. The demo "ExtendedFileSystem.PC6" shows you how to setup a monitoring function to periodically monitor the progress of the file transfer and report the transfer status on the LCD display.

Please refer to the comments in the custom function "fnConnFTP" and "fnMonFTP" of the "ExtendedFileSystem.PC6" program for more detailed descriptions of each command involved in the FTP file transfer.

## 18.8 Setting Up A FTP Server Behind a Windows Firewall.

Please refer to the following Microsoft document describing issues and solutions related to FTP server behind the Windows Firewall.

[http://technet.microsoft.com/en-us/library/dd421710\(WS.10\).aspx](http://technet.microsoft.com/en-us/library/dd421710(WS.10).aspx)

Microsoft focuses mainly on the FTP server in their IIS server (for obvious reasons) instead of Filezilla. If you are setting Filezilla as a permanent FTP server behind a software firewall you can try to make the following configuration setup:

1) You must specifically setup a range of port number for Passive mode use. These are the port number that Filezilla will assign to the PLC to make a data channel connection when it attempts to transfer a file using passive mode. The following is an example where two port numbers are assigned so that two PLCs may connect to the Filezilla simultaneously. You can add a larger port range if more PLCs may connect to the FTP Server simultaneously.

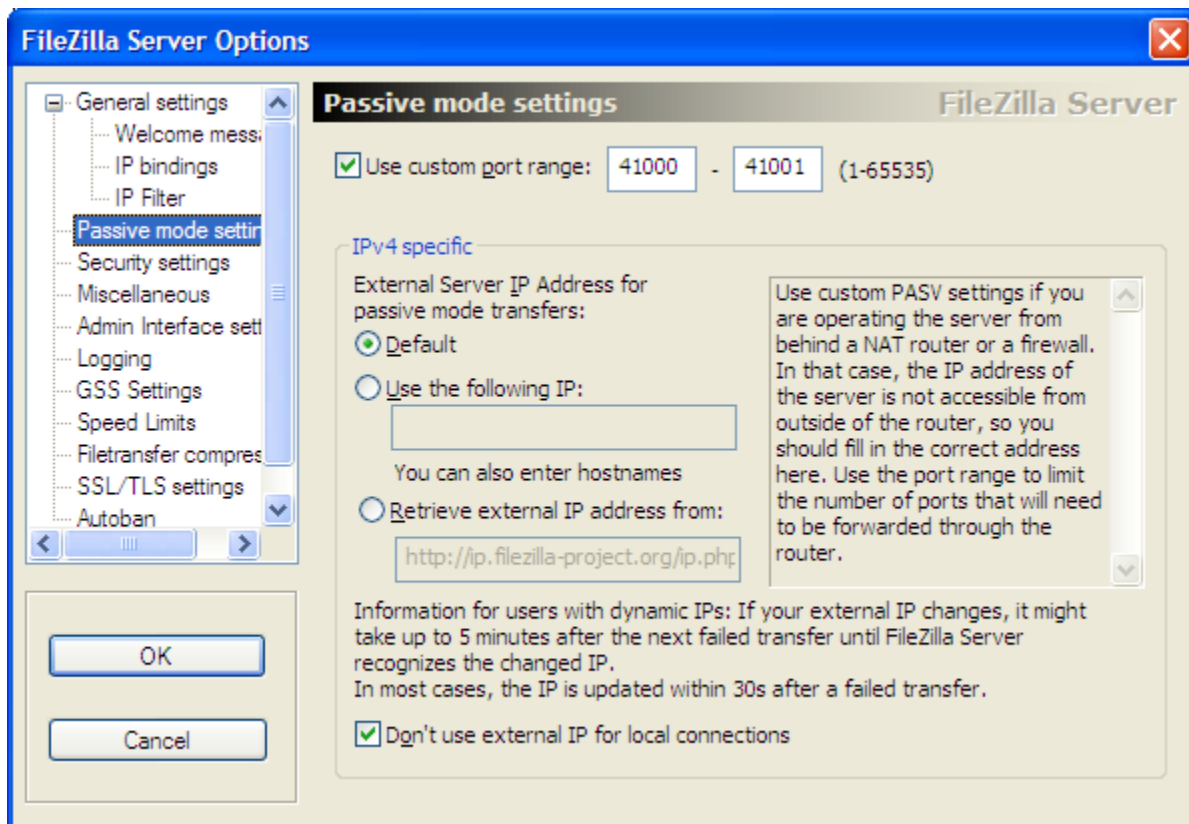

Next, open up Windows Firewall and add to the Exception list the port 21 (command port) and ports 41000 to 41001 (or whatever range limit you have set to in the FileZilla Setup screen). This should allow the FTP Server to receive connection from these ports that the PLC will be using to make the command and data connections.

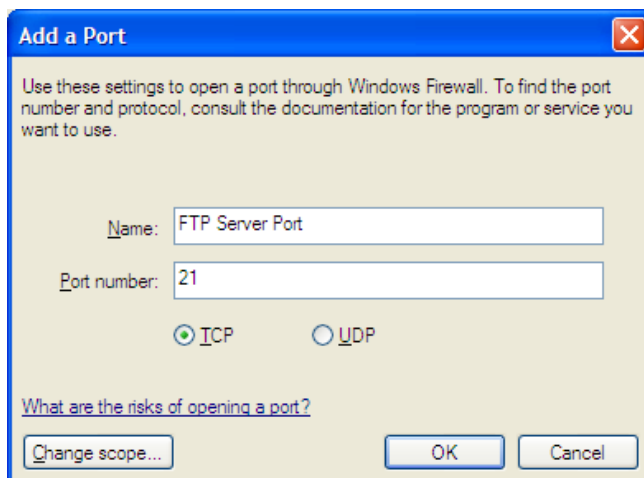
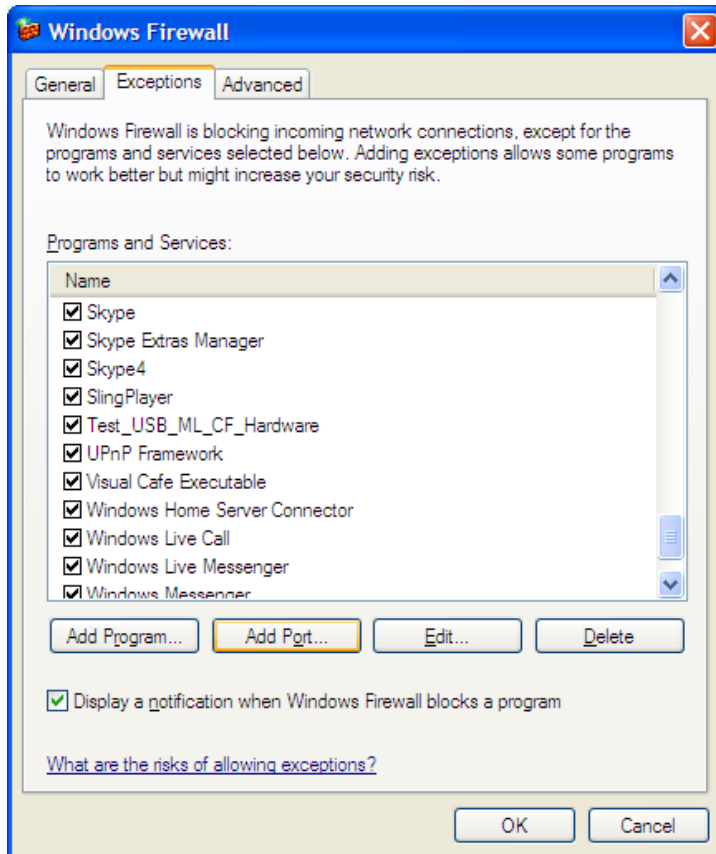

## Chapter 19 PLC As A Modbus/TCP Gateway

## 19 USING PLC AS A MODBUS/TCP GATEWAY

### 19.1 Introduction

A Nano-10, FMD or F-series PLC with r77 firmware or later can be configured to act as the "MODBUS/TCP GATEWAY" for other Modbus serial devices while continue to function as a Super PLC!

A Modbus/TCP gateway essentially translates a Modbus/TCP command packet it receives from its Ethernet port into a Modbus RTU serial command and sends it out of its serial port (RS232 or RS485). If the Modbus RTU slave sends back a serial response, the gateway will in turn translate the RTU response data back to Modbus/TCP response packet and return to the client via the Ethernet port.

As such the Modbus/TCP gateway enables any non-Ethernet equipped, both TRi or 3rd party serial Modbus slave device to be directly accessible by a Modbus/TCP client via the Ethernet or the Internet. In addition, the user PLC program does not need to handle the gateway function at all as the CPU performs the translation functions automatically and transparently to the PLC's program.

Best of all, while acting as a gateway, the Nano-10, FMD or F-series PLC program can **simultaneously act as a Modbus master PLC** and read/write to any registers inside any of the attached Modbus RTU slave! The CPU firmware automatically schedules the order of the command/response packets whether it is originated from the client or from the PLC itself so that the Modbus/TCP command from the client will be responded to in the correct order and in a timely manner.

### 19.2 Application Ideas for Modbus/TCP Gateway

The Modbus/TCP gateway function can be very useful for many large area control systems, such as a building automation system. A master FMD or F-series PLC is linked to many Modbus RTU slave controllers via RS485 bus distributed across an entire building. The master PLC can perform sophisticated control functions since it has read/write access to **ALL** the Modbus RTU slaves it connects to. At the same time, a Modbus TCP client software such as a Building Management System (BMS) can access any registers in the master PLC or **ANY** of the slave Modbus RTU controller directly via the master PLC acting as a gateway for the slave PLCs.

### 19.3 Configuring The PLC As Modbus/TCP Gateway

The command used to define a serial port to become Modbus/TCP Gateway serial port is as follow:

```
SETSYSTEM 12, n
```

Where n = 1, 2 or 3 for COMM1, COMM2 and COMM3 port.

This statement must be run once (could be during start up via 1st.Scan pulse) to configure the serial port #n to be used to send out RTU commands and received RTU responses. If SETSYSTEM 12,n is not run then the Modbus gateway function will be disabled.

Here is how it works: A Modbus/TCP client (such as a SCADA, HMI etc) would send a Modbus/TCP request with a specific 8-bit Modbus slave ID to the gateway PLC. If the ID **matches** the native ID that is assigned to the gateway PLC then the PLC will react normally by sending its own Modbus/TCP response packet back to the client. The PLC will not send any RTU command out of the gateway serial port. This means that the client can access the master PLC's own register as per normal.

However, if the client send a Modbus/TCP packet with a different ID from that of the gateway PLC's ID, then the gateway PLC will translate the command into a Modbus RTU command and send it out of the gateway serial port #n defined by the "SETSYSTEM 12, n" statement. The PLC will also wait for a response from the RTU slave via the gateway serial port, and if it does receive a response it will translate it into Modbus/TCP response packet and return to the client.

**Note:**

- 1) If the Modbus/RTU slave being addressed does not respond to the RTU command, then the gateway PLC will wait till time-out (default is about 150ms) and then resend the Modbus RTU command and wait for a response again. By default the gateway PLC will repeat this procedure twice and if it still doesn't receive a response after repeated attempts, it will send back a "TARGET DEVICE FAILED TO RESPOND" error packet back to the Modbus/TCP client. (i.e. It will set the 7<sup>th</sup> bit of the function code to "1" and send back an exception code "0B" hex).
- 2) The CPU firmware is designed to handle only one Modbus gateway translation for each Modbus/TCP connection per ladder logic scan. This is to ensure that the CPU is not completely bogged down by its Modbus gateway job and will have time to run its own program. If the Modbus/TCP clients attempt to overload the PLC with more requests than it can handle the PLC will frequently return "SLAVE DEVICE BUSY" error response packets back to the client. (i.e. It will set the 7<sup>th</sup> bit of the function code to "1" and send back an exception code "06").

### 19.4 Fine-Tuning The Modbus/TCP Gateway Function

It is important to know that every time the PLC runs a Modbus/TCP to Modbus RTU translation its own program scan time increases due to the need for the CPU to wait for a response from the slave Modbus RTU devices. The delay becomes much more pronounced when a Modbus slave device fails to respond (e.g. not online). The system designer must therefore take this into consideration when designing the system:

- 1) The Modbus/TCP client should not overload the Modbus gateway with unnecessarily frequent Modbus requests. Whenever the PLC report a "TARGET DEVICED FAILED TO RESPOND" function the client program should back off for a while before re-trying communication with the Modbus/RTU slaves again.
- 2) You can change the number of wait states the gateway will wait for a response from the Modbus/RTU slave by running:

```
SETSYSTEM 1, w
```

Where w = number of serial port wait states for each COMM port as follow:

Bit 7	Bit 6	Bit 5	Bit 4	Bit 3	Bit 2	Bit 1	Bit 0
Ethernet		COMM3		COMM2		COMM1	

Thus each COMM port could be configured to wait from 0 to 3 wait states for a response. The default settings for w = &H55 (or 01010101 binary) which means each COMM port as well as the Ethernet port uses 1 wait state of about 150ms..

- 3) You can change the number of retries (default = 2) the gateway will attempt to get a response from the Modbus RTU slave by running:

```
SETSYSTEM 2, n
```



Where n = number of retries for each COMM port as follow:

Bit 7	Bit 6	Bit 5	Bit 4	Bit 3	Bit 2	Bit 1	Bit 0
Ethernet		COMM3		COMM2		COMM1	

Thus each COMM port could be configured to re-attempt to send the command from 0 to 3 times if it does not get a response from a Modbus RTU slave.

The default settings for n = &HAA (or 10101010 binary) which means each COMM port as well as the Ethernet port will retry twice (making a total of 3 attempts). E.g. If you run SETSYSTEM 2, 0 the gateway will not resend the RTU command on any of its COMM port if does not receive a response on the first attempt. This can help to reduce the CPU scan time if a Modbus RTC slave does not respond.

- 4) We strongly recommend that the serial port #n that is to be used as a gateway serial port be configured to be "No protocol" by running the SETPROTOCOL n, 10 statement once. This is to ensure that the serial data returned from the RTU slaves will never be interpreted wrongly by the master PLC as incoming commands, which could lead to errors. (The same advise applies to PLC programs that use the serial port to run READMODBUS, WRITEMODBUS, READMB2 and WRITEMB2 commands).

## 19.5 Modbus/TCP Gateway Sample Program

Please download the following self-explanatory I-TRiLOGI sample program that demonstrates the new Modbus/TCP Gateway capability via any of the selected COMM port:

<http://www.tri-plc.com/trilogi/modbusgateway.zip>